

Gooxi

Whitley Platform L-shape Server Barebones



User Manual

V1.0

Shenzhen Gooxi Information Security Co., Ltd.

Dear user:

Copyright© Shenzhen Gooxi Information Security Co., Ltd. All rights reserved.

This user manual, including but not limited to all the information contained in it, is protected by Copyright Law. Without the permission of Shenzhen Gooxi Information Security Co., Ltd. (hereinafter referred to as "Gooxi"), it is not allowed to imitate, copy, extract, redistribute or use for other purposes.

Disclaimer

Gooxi provides this user manual "present situation" and does not provide any express or implied warranties and guarantees to the extent permitted by law, including but not limited to commercial marketability, suitability for specific purposes, non-infringement of any other person's rights and any. The use of this user manual or the inability to use this user manual guarantees, and Gooxi does not guarantee and guarantee the accuracy or reliability of the results obtained from the use of this user manual or any information obtained through this user manual.

Due to product version upgrades or other reasons, the contents of this user manual will be updated from time to time. Unless otherwise agreed, this user manual is only used as a guide, and the user should bear all the risks of using this user manual.

Trademark Statement

Gooxi is a trademark of Shenzhen Gooxi Information Security Co., Ltd.

Intel and Xeon are trademarks of Intel Corporation in the US and other countries.

Microsoft and Windows are trademarks of companies within the Microsoft group of companies.

Linux is a registered trademark of Linus Torvalds.

Aspeed is a trademark of ASPEED Technology Inc..

The ownership of other trademarks belongs to their respective owners.

Product name: Gooxi Whitley platform L-shape server barebones

Manual Version: V1.0

Address: Area A, 5th Floor, Block A3, Digital Technology Park, Gaoxin South 7th Road, High-tech Park, Nanshan District, Shenzhen, Guangdong, China

Postcode: 518000

Website: <https://www.gooxi.com>

Words	Paraphrase
Platinum Efficiency Power Supplies	The platinum certified power supply is the "80 PLUS Platinum" standard, that is, the conversion rate of 20% load is above 90%, the conversion rate of 50% load is above 94%, and the conversion rate of 100% load is above 91%
M.2	The M.2 port is a new-generation port standard tailored for Ultrabook. It is a new port specification introduced by Intel® to replace mSATA.
C620A	Intel® Chipset
RJ45	Common name for standard 8-bay modular interface
AST2500	Aspeed® BMC Chip
Socket P	Intel® processor interface types
-F CPU	Refers to the CPU that supports the Intel® Omni-Path Host Fabric interface, Omni-Path high-speed optical cable interconnection technology, which can support up to 100Gbps end-to-end interconnection
8038 Fan	Fan with dimensions 80x80x38mm
LGA 4189	Full name is Land Grid Array, LGA 4189 represents 4189 contacts
CR2032	3V CR2032 lithium manganese battery , shaped like a button, referred to as a button







	battery or a lithium manganese button battery
RS-232	One of the communication interfaces on the computer is the asynchronous transmission standard interface, called COM port
Jtag	Joint Test Action Group, a joint test working group, mainly used for internal chip testing
NC Pin	Empty pin
XDP	Extend Debug Port, Intel [®] CPU debugging interface

Glossary:

Abbreviation	Original	Chinese meaning
PCH	Platform Controller Hub	即之前统称的“南桥”
GbE	Gigabit Ethernet	千兆以太网
BMC	Baseboard Management Controller	基板管理控制器
IPMI	Intelligent Platform Management Interface	智能平台管理接口
CPU	Central Processing Unit	中央处理器
SATA	Serial Advanced Technology Attachment	串行 ATA 接口规范
SAS	Serial Attached SCSI	串行 SCSI
sSATA	secondary SATA	扩展 SATA 接口
LAN	Local Area Network	局域网
VGA	Video Graphics Array	视频传输标准
MB	Mother Board	主板
MIB	Motherboard Interface Board	主板转接板/侧板
BP	Backplane	背板
PCIE	Peripheral Component Interconnect Express	高速串行计算机扩展总线标准
USB	Universal Serial Bus	通用串行总线
FW	Firmware	固件
TPM	Trusted Platform Module	可信平台模块
IO	Input/Output	输入输出
BIOS	Basic Input-Output System	基本输入输出系统
CMOS	Complementary Metal Oxide Semiconductor	互补金属氧化物半导体
ME	Management Engine	管理引擎
DDR4	Double Data Rate 4 SDRAM	第四代双倍数据速率同步动态随机存储器
DIMMs	Dual-Inline-Memory-Modules	双列直插式存储模块
RDIMMs	Registered DIMMs	带寄存器的双线内存模块
LRDIMM	Load-Reduced DIMMs	低负载 DIMM
AEP	Apache Pass	Intel [®] 傲腾 DDR4 内存代号
MEZZ CONN	Mezzanine Connector	夹层/扣卡

KVM	Keyboard Video Mouse	通过直接连接键盘、视频、鼠标端口，能够访问和控制计算机
CPLD	Complex Programmable Logic Device	复杂可编程逻辑器件
ECC	Error Correcting Code	错误检查和纠正
CFM	Cubic Feet Per Minute	立方英尺每分钟
RPM	Revolution Per Minute	转每分

Conventions:

	Note: Used to convey equipment or environmental safety warning messages, which, if not avoided, may result in equipment replacement, data loss, reduced equipment performance, or other unpredictable results.
	Red arrow: Represents pointing to a location
	Blue arrow: represents the action of pulling out or inserting downward or inserting at an angle
	Hollow arrows: represent the next action or result
	Dark blue rotation arrow 1: Represents the action of turning the screw clockwise or pulling outward
	Dark blue rotation arrow 2: Represents the action of turning the screw counterclockwise or snapping it inward
	

Note: Used to convey equipment or environmental safety warning messages, which, if not avoided, may result in equipment replacement, data loss, reduced equipment performance, or other unpredictable results.

Manual version	Release date	Modify the description
V1.0	2021-AUG-1	Initial Release

CONTENTS

CHAPTER 1 SAFETY STATEMENT.....	8
1.1 GENERAL SAFETY MATTERS.....	8
1.2 TOXIC AND HAZARDOUS SUBSTANCES OR ELEMENTS IN PRODUCTS.....	9
1.3 WARNING NOTICES.....	10
1.4 CLIMATE AND ENVIRONMENTAL REQUIREMENTS.....	10
1.5 OTHER IMPORTANT DESCRIPTIONS.....	11
CHAPTER 2 PRODUCT INTRODUCTION.....	12
2.1 SYSTEM INTRODUCTION.....	12
2.2 PRODUCT FEATURES.....	12
2.2.1 System parameters.....	12
2.2.2 System Architecture.....	14
2.3 INTRODUCTION OF SYSTEM COMPONENTS.....	15
2.3.1 Front Panel Components.....	15
2.4.2 Rear Panel Components.....	19
Rear panel port description.....	20
2.4.3 Motherboard Components.....	21
2.4.4 HDD Backplane Components.....	24
2.4.5 DIMM slot locations.....	32
2.4.6 Hard disk label.....	32
2.4.7 Hard disk indicator.....	33
2.4.8 System Fan.....	34
CHAPTER 3 INSTALLING SYSTEM COMPONENTS.....	35
3.1 INSTALLATION OF CPU.....	35
3.2 INSTALLATION OF HEAT SINK.....	35
3.3 MEMORY INSTALLATION.....	36
3.3.1 Memory Support Specifications.....	36
3.3.2 How to install memory.....	37
3.4 HARD DISK INSTALLATION.....	38
3.5 FRONT HARD DISK BACKPLANE INSTALLATION.....	40
3.6 M.2 SSD INSTALLATION.....	41
3.7 INSTALLATION OF PCI-E EXPANSION CARD.....	42
3.8 PCI-E MODULE INSTALLATION.....	43
3.9 REAR HARD DISK MODULE BACKPLANE INSTALLATION.....	44
3.10 REAR HARD DISK MODULE INSTALLATION.....	45
3.11 INSTALLATION OF POWER MODULE.....	46
3.12 INSTALLATION OF THE FAN MODULE.....	47
3.13 INSTALLATION OF THE WIND SHIELD.....	48
3.14 INSTALLATION OF CD/DVD-ROM.....	48
3.15 INSTALLATION OF THE UPPER COVER OF THE CHASSIS.....	50
CHAPTER 4 SYSTEM RACK INSTALLATION.....	51
4.1 MOUNTING ON THE INNER RAIL OF THE GUIDE RAIL.....	51
4.2 INSTALLING THE OUTER RAILS TO THE RACK.....	51
4.3 INSTALL THE SERVER TO THE RACK.....	52

CHAPTER 5 BIOS PARAMETER SETTINGS.....	54
5.1 ENTER THE BIOS SETUP INTERFACE.....	54
5.2 SETUP MENU PARAMETER DESCRIPTION.....	54
5.2.1 Navigation Key Description.....	54
5.2.2 Main menu description.....	54
5.2.3 Advanced menu description.....	56
5.2.4 Trusted Computing.....	58
5.2.5 Serial Port Console Redirection.....	59
5.2.6 Console Redirection Settings.....	60
5.2.7 SIO Configuration.....	61
5.2.8 [*Active*] Serial Port.....	62
5.2.9 Option ROM Dispatch Policy.....	63
5.2.10 PCI Subsystem Settings.....	64
5.2.11 CSM Configuration.....	65
5.2.12 NVMe Configuration.....	66
5.2.13 Network Stack Configuration.....	67
5.2.14 iSCSI Configuration.....	68
5.2.15 Platform Configuration menu.....	69
5.2.16 PCH SATA Configuration.....	70
5.2.17 PCH sSATA Configuration.....	71
5.2.18 USB Configuration.....	72
5.2.19 Miscellaneous Configuration.....	73
5.2.20 Server ME Configuration.....	74
5.2.21 Runtime Error Logging.....	74
5.2.22 Socket Configuration menu.....	75
5.2.23 Processor Configuration.....	76
5.2.24 Common RefCode Configuration.....	79
5.2.25 UPI Configuration.....	80
5.2.26 Memory Configuration.....	82
5.2.27 Memory Topology.....	84
5.2.28 Memory Map.....	85
5.2.29 Memory RAS Configuration.....	86
5.2.30 Ticket Configuration.....	88
5.2.31 Advanced Power Management Configuration.....	90
5.2.32 CPU P State Control.....	91
5.2.33 Hardware PM State Control.....	92
5.2.34 CPU C State Control.....	93
5.2.35 Package C State Control.....	94
5.2.36 CPU-Advanced PM Tuning.....	95
5.2.37 Energy Perf BIAS.....	96
5.2.38 Server Mgmt Menu.....	97
5.2.39 System Event Log menu.....	98
5.2.40 BMC network configuration menu.....	99
5.2.41 View System Event Log menu.....	102
5.2.42 BMC User Setting.....	103
5.2.43 Add User.....	104
5.2.44 Delete User.....	105
5.2.45 Change User Setting.....	106

5.2.46 Security menu.....	107
5.2.47 Boot menu.....	108
5.2.48 Save & Exit menu.....	109
5.3 USER OPERATION REMINDER.....	109
CHAPTER 6 RAID SETUP INSTRUCTIONS.....	111
6.1 PCH GROUP RAID.....	111
6.1.1 Configuring RAID in UEFI Boot Mode.....	111
6.1.3 Configuring RAID in Legacy Boot Mode.....	118
6.2 RAID CARD SET RAID.....	126
6.2.1 Configuring RAID in UEFI Boot Mode.....	126
6.2.2 Configuring RAID in Legacy Boot Mode.....	170
CHAPTER 7 IPMI RAPID DEPLOYMENT.....	188
7.1 RAPID DEPLOYMENT OF IPMI PROCESS.....	188
7.1.1 Make sure the motherboard supports the IPMI function.....	188
7.1.2 Enter BIOS to set IPMI function.....	188
7.1.3 IPMI port configuration Static mode.....	191
7.1.4 IPMI configuration Java SOL.....	191
7.2 QUICK START INSTRUCTIONS FOR IPMI FUNCTIONS.....	192
7.2.1 Enter the operation interface.....	192
7.2.2 Default Username and Password.....	193
7.2.3 Contents of IPMI Management System.....	193
7.2.4 Introduction to KVM Remote Management.....	194
7.2.5 KVM page introduction.....	195
7.2.6 Remote control shortcut operation.....	196
7.2.7 Introduction to SOL.....	196
7.3 OTHER WAYS TO CONNECT TO IPMI.....	198
7.3.1 IPMI driver.....	198
7.3.2 IPMI tools and other open source software.....	198

Chapter 1 Safety Statement

1.1 General safety matters

To prevent the risk of significant personal and property damage, be sure to follow the recommendations below.

Please do not open the system cover by yourself, it should be operated by professionally trained maintenance technicians. Do not touch the triangle-marked portion with the lightning bolt that may be subject to high voltage or electric shock.

IMPORTANT: Disconnect all cables before servicing. (There may be more than one cable)

It is strictly forbidden to carry out live operations such as starting the machine before the cover is closed.

When it is necessary to open the cover, please wait for the internal equipment to cool before performing it, otherwise it may cause burns to you.

Do not use this device in wet environments.

If an extension cable needs to be used, use a three-wire cable and make sure it is properly grounded.

Make sure the computer is well grounded. Different grounding methods are possible, but they must be physically connected to ground. If you are not sure whether the grounding protection is safe, please contact the appropriate agency or electrician to confirm. If cable routing is required, please contact Gooxi Hengyun Information Security Co., Ltd. for advice.

Please use a three-core power cord and socket with grounding protection. Improper grounding may cause leakage, burnout, or even personal injury.

Please ensure that the power socket and the power interface can be in close contact, loose contact may cause a fire hazard.

Please use your computer under 220V AC voltage. Working with inappropriate voltage will cause the danger of electric shock, fire and damage to the computer.

It is required that the computer is well ventilated and kept away from heat, fire, and cooling fans, otherwise the computer may be at risk of smoke, fire or other damage due to overheating.

If you smell or see smoke from your computer, shut down the computer immediately and unplug the power cord.

The power cord is required to be easily accessible from the power source and the power outlet. Please keep the power cord and plug clean and undamaged, otherwise there may be a risk of electric shock or fire.

Note: There is a danger of explosion if the battery is improperly replaced. Only use the replacement parts of the same or equivalent type recommended by the manufacturer. The used battery will pollute the environment. Please set the replaced old battery according to the relevant instructions.

Keep your computer away from electromagnetic fields.

Stay away from electronic noise caused by high-frequency safety equipment such as air conditioners, large fans, and large motors for radio and television stations.

Please do not plug or unplug the backplane cable or move the computer while the computer is running, otherwise the computer may crash or parts may be damaged.

Please try to avoid frequent restart or power on and off to prolong the life of your computer.

Please keep the environment clean and avoid dust. The temperature of the equipment working environment is 10°C~40°C, and the humidity is 35%~80%.

Please back up important data in time, Shenzhen Gooxi Information Security Co., Ltd. is not responsible for data loss caused by any circumstances.

The optical drive used in this product is a Class 1 laser device.

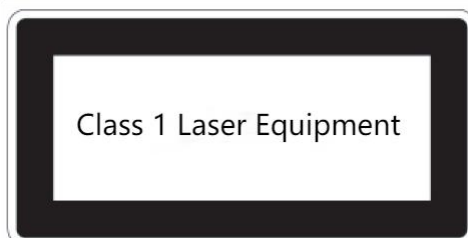

Figure 1- 1

1.2 Toxic and hazardous substances or elements in products

During the 10-year environmental protection use period, the toxic and harmful substances or elements contained in the product will not leak or mutate under normal use conditions, and the use of electronic information products by users of electronic information products will not cause serious pollution to the environment or serious damage to persons and property.

Component	Hazardous Substances					
	Pb	Hg	Cd	Cr VI	PBB	PBDE
Chassis / Baffle	X	O	O	O	O	O
Mechanical components (fan, heat sink, motor, etc.)	X	O	O	O	O	O
Printed circuit components - PCA*	X	O	O	O	O	O
Cable / Wire / Connector	X	O	O	O	O	O
HDD	X	O	O	O	O	O

Table 1- 1

Component	Harmful Substances					
	Pb	Hg	Cd	Cr VI	PBB	PBDE
Media read / Store device (CD, etc.)	X	O	O	O	O	O
Power supply / adapter	X	O	O	O	O	O
Power cord	X	O	O	O	O	O
Pointing device (mouse, etc.)	X	O	O	O	O	O
Keyboard	X	O	O	O	O	O

UPS	X	O	O	O	O	O
Complete rack / Rail products	X	X	O	O	O	O

Table 1- 2

○ means that the content of the toxic and harmful substance in all homogeneous materials of the component is below the limit specified in GB/T26572-2011 *Limit Requirements for Restricted Substances in Electronic and Electrical Products*.

× indicates that the content of the toxic and harmful substance in at least one homogeneous material of the component exceeds the limit requirements specified in GB/T26572-2011 *Limit Requirements for Restricted Substances in Electronic and Electrical Products*. However, it complies with the EU RoHS Directive (including its exemption provisions).

Note: the table shows the information of toxic and hazardous substances in all possible components of Gooxi server, storage and workstation products. Customers can refer to the status of toxic and hazardous substances in all components of the purchased products according to this table.

1.3 Warning notices

This product complies with EMC Class A standards.

1.4 Climate and Environmental Requirements

◆ The best working temperature of the equipment is 10°C-40°C; the maximum indoor ambient temperature of the equipment is 40°C.

◆ System battery 3 V CR2032 lithium battery

NOTE: Some configurations have been verified for performance at 45°C temperature and 90% (29°C maximum dew point) humidity.

Temperature	
Working temperature	10 °C~40°C (50 °F~104 °F), the maximum temperature gradient is 10 °C per hour
Continuous operating temperature range (below 950m or 3117ft above sea level)	In the situation of no direct illumination, 10 ° C to 40 ° C (50 °F to 104 °F)
Storage temperature range	-40°C~65°C (-40°F~149°F)
Humidity	
Storage	The max. dew point is 33°C (91°F). The relative humidity is 5% to 95%. The air must not condense at all times.
Continuous operating humidity percentage range	The max. dew point is 26°C (78.8°F) The relative humidity is 10% to 80%

Table 1- 3

- ◆ If the lightning protection facilities of the computer are poor or not available, please shut down the computer in thunderstorm weather and unplug the power line, network cable, telephone line, etc. connected with the computer.
- ◆ Please use the authorized operating system and software and configure them correctly. Shenzhen Gooxi Information Security Co., Ltd. is not responsible for server failure caused by operating system and software.
- ◆ Please do not disassemble the chassis, increase or decrease the hardware configuration of the server. Shenzhen Gooxi Information Security Co., Ltd. is not responsible for the hardware and data damage caused by this.
- ◆ When the server fails, please first check the "troubleshooting" section of this manual to determine and remove common faults. If you are not sure the cause of the failure, please contact the technical support department of Shenzhen Gooxi Information Security Co., Ltd. for help.
- ◆ Choosing a suitable environment for the computer is helpful for the stable operation and can prolong the life of the computer.

Shenzhen Gooxi Information Security Co., Ltd. reserves the right of final interpretation of the above terms

1.5 Other important descriptions

 If the equipment is marked with a label, it means that the equipment with the label is only designed and evaluated as the altitude of 2000m. Therefore, it is only suitable for safe use below 2000m, and there may be potential safety hazards when it is used above 2000m.

 If the equipment is marked with this mark, it means that the equipment with this mark is only designed and evaluated based on non tropical climate conditions. Therefore, it is only suitable for safe use in non tropical climate conditions, and there may be potential safety hazards when it is used in tropical climate conditions.

Chapter 2 Product Introduction

2.1 System introduction

Gooxi Whitley dual-socket L-series servers are based on the Intel Whitley platform, and are widely used 1U, 2U, 4U dual-socket servers for the Internet, IDC (Internet Data Center), cloud computing, enterprise market and telecom business applications. Rack-mounted L-shape storage server. It is suitable for high-density deployment of loads such as cloud computing, virtualization, high-performance computing (HPC), and big data processing to improve data center space utilization. The server has the advantages of large storage capacity, strong expansion capability, high reliability, easy management, and easy deployment.

2.2 Product Features

- ◆ The CPU adopts 1 or 2 third-generation Intel® Xeon® Scalable processors (ICE Lake) 8300/6300/5300/4300 series processors, LGA4189 socket, TDP 270W;
- ◆ 32 DDR4 memory slots support DDR4 LRDIMM/RDIMM/ECC, the memory frequency supports 2400/2666/2933/3200MHz, and the maximum memory capacity is 12TB;
- ◆ Standard one 3 PCIE 3.0x 8 riser cards, 11 PCIE 3.0 expansion slots (including 1 OCP 3.0 slot), support 2 full-width, full-length GPU cards;
- ◆ The motherboard has two built-in PCIE 4.0x 4 M.2 ports;
- ◆ Modular design, various combinations of PCIE and hard drives are available
- ◆ Support 4/8/12/24/25/36* 2.5-inch or 3.5-inch hard disks, support flexible conversion of various NVME models
- ◆ Onboard 2 Gigabit data network ports and one Gigabit management network port
- ◆ Optional 1 OCP3.0 network card module.

2.2.1 System parameters

Processor and memory	
Processor	Support 1 or 2 third-generation Intel Whitley platform full series processors, LGA4189 socket
TDP	Maximum support 270W
Amount of processor cores	Up to 40 cores
Amount of processors	2
Memory type	DDR4 ECC RDIMM/LRDIMM, memory frequency supports 2400/ 2667 / 2933/ 3200MHz, single CPU supports 8 DDR4 channels , each channel supports 2 DIMMs ; 2 CPUs support a total of 32 DDR4 slots support a single. The capacity is 16GB, 32GB, 64GB, 128GB, 256GB, maximum support 4TB memory capacity (16* 256GB LRDIMMs), support Barlow Pass DIMMs (CR 1.5), maximum support 12 TB memory capacity (8* 256GB LRDIMM + 8 512GB Barlow Pass mapped as memory)
Storage and I/O	
storage controller	Internal storage: 2 SATA ports (7Pin), 3 Minisas 8643 ports, 2 PCIe 4.0 X4 M.2 ports, 2 slimline x8 ports
Driver	Support 4, 8, 12, 24, 36* 3.5/2.5-inch hot-swap SATA/SAS HDDs, 25* 2.5-inch

	hot-swap SATA/SAS HDDs, and the rear upper layer is optional and supports 2* 2×3.5 inch SAS/SATA or 2* 2×2.5 inch SAS/SATA or NVME hot-swap hard drives.
External port	Front port: 2 USB3.0, 1 VGA port
	Rear: 1 VGA, 1 DB-9COM port, 2 USB3.0, 1 RJ45 Gigabit management network port, 2* Gigabit/10 Gigabit RJ45 network ports
BMC	ASPEED AST2500
PCIe expansion	Support 2 PCIe 4.0 x32 slots (can be converted into various types of PCIE slots through PCEI adapter board) , 1 PCIe 4.0 x16, 1 OCP 3.0 (PCIe3.0 x8 signal), 2 Slimline (PCIe4.0 x8 Signal)
TPM	Support
Power supply	
Power supply	Platinum 550W, 800W, 1200W, 1600W , 2200W hot- swap redundant power supply (adapt according to actual power)
System fan	
Fan	Support 4* 8038 fans (optional 4* 8056 fans)
Remote management	
BMC chip	ASPEED AST2500
IPMI Compliant	IPMI2.0
Management port	1 dedicated RJ45 management network port
System depth	System depth 748MM.
Option Family Support List	
System	CentOS 7.5/7.6/8.0/8.1 RHEL 7.4/7.5/7.6/8.0/8.1 SLES12 SP3/SP4 Ubuntu 18.04 / Ubuntu-20.04- Fedora 28 Windows 10 Win server 2012 R2/2016/2019 Xenserver 7.1/ 7.2/ ESXi 6.7/ 7.0U1c Windows Server 2012 2016 Hyper-V
BIOS	
Name	AMI
Support start mode	HDD (internal)/CD/USB/PXE
TPM support	Yes
Safety certificate	
Nation	Asia, Europe, America, Australia, Africa
Energy saving certification	CECP, CELP
Safety certificate	CCC, CE, FCC
RoHS	Meet the requirements
Environmental parameters	
Operating temperature	5 °C ~ 40 °C

Working humidity	35% ~ 80%
Storage temperature	-40°C ~ 70°C
Storage humidity	Humidity: 20%~90% (including packaging)

Table 1- 4

2.2.2 System Architecture

SL series server products include 1U models (SL101-D04R, SL101-D10R), 2U models (SL201-D08R, SL201-D12RE, SL201-D12R, SL201-D25RE, SL201-D08R-NV, SL201-D12R-NV) 4U models (SL401-D24RE, SL401-D36RE) bays, motherboard name: G4DCL-B, the models are the same except for the hard disk connection method and the maximum number of compatible hard disks.

The main board features are as follows:

- ◆ The CPU adopts the third -generation Intel® ICE- Lake® scalable processor, LGA 4189 socket, TDP 270 W; single processor can reach up to 40 cores, providing excellent system performance, the highest frequency is 3.2GHz, using Intel the largest single core that can be achieved by the Turbo acceleration technology, the maximum overclocking (Max Turbo Frequency) is 3.4GHz;
- ◆ Supports Intel Hyper-Threading Technology, allowing multiple threads to run concurrently on each processor core (up to 2 threads per core) to improve multi-threaded application performance;
- ◆ Each CPU supports 8 DDR4 channels , each channel supports 2 memory sticks, RDIMM/LRDIMM;
- ◆ Supports up to 32* 2400/2666/2933/3200 MHz DDR4 LRDIMM/RDIMM/ECC memory, and supports a single capacity of 8GB, 16GB, 32GB, 64GB, 128GB, 256GB. Supports Intel's second-generation Optane memory BPS (maximum 512GB per DIMM);
- ◆ There are 3 PCIE RISER slots on the board, among which: RISER1: 32 PCIE LANEs all come from CPU0, RISER2: 32 PCIE LANEs all come from CPU1, RISER3: 16 PCIE LANEs come from CPU1;
- ◆ Motherboard integrated AST2500 BMC chip, standard KVM function
- ◆ G4DCL-B motherboard provides 2* M.2 Key M SSD slots, supports 2280 size, only supports PCIe 4.0 X 4 signals;
- ◆ 2 Gigabit Ethernet ports are integrated on the motherboard, using 88E1512 chip from PCH;
- ◆ South bridge PCH adopts INTEL LEWISBURG C620A series chipset;
- ◆ Modular design of hard disk module, PCIE expansion module, power supply, fan and other components, tool-free maintenance
- ◆ PCH leads out 14 SATA Ports, maximum speed: 6Gb/s, compatible with SATA 1.5Gb/s, 3.0Gb/s; SATA Controller outputs 8 SATA PORTs, while SSATA outputs 6 SATA PORTs, of which SATA PORT has 8 PORTs, according to Sequentially introduced into 2 SFF - 8643 connectors, while the first 4 PORTs of SSATA are introduced into a SFF - 8643 connector, and the latter 2 PORTs are introduced into 7PIN SATA connectors for connecting SATA DOM and DVD;
- ◆ The BMC chip in this single board adopts the AST2500 control chip of ASPEED Company, which is used for IPMI remote management. VGA output port, dedicated Gigabit RJ45 management network port, and connected to PCH via RMII/NCSI.

The system architecture motherboard block diagram is as follows:

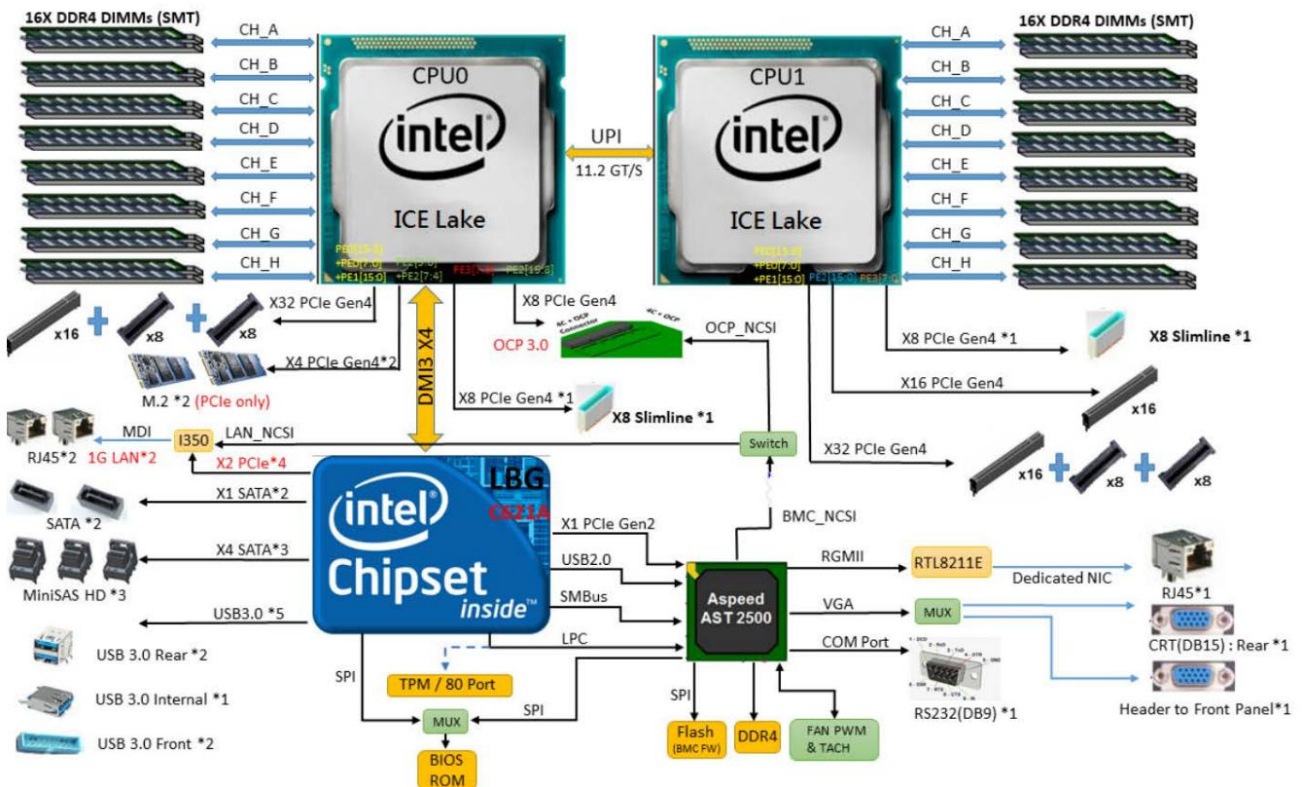
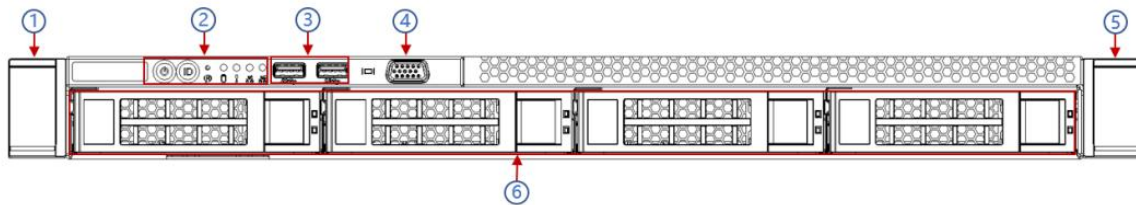

Figure 2- 1

2.3 Introduction of system components

2.3.1 Front Panel Components

1U4-bay model



Serial number	Name	Serial number	Name
1	Left ear	4	VGA port
2	Front Panel Indicators	5	Right ear
3	USB3.0 port	6	3.5 inch hard drive

1U10 disk model

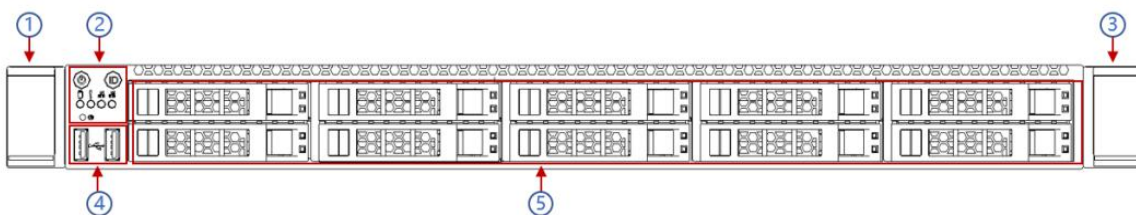

Serial number	Name	Serial number	Name
1	left ear	4	USB3.0 port

2	Front Panel Indicators	5	2.5 Hard Disk
3	Right ear		

2U8-bay model

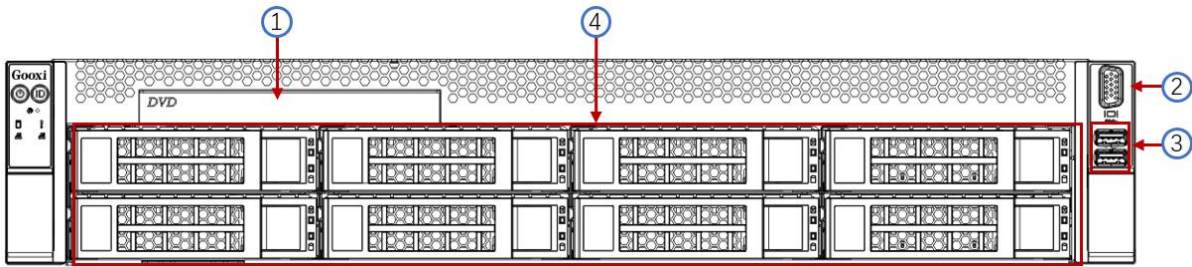

Serial number	Name	Serial number	Name
1	DVD drive	3	USB3.0 port
2	VGA port	4	3.5 inch hard drive

2U12-bay model

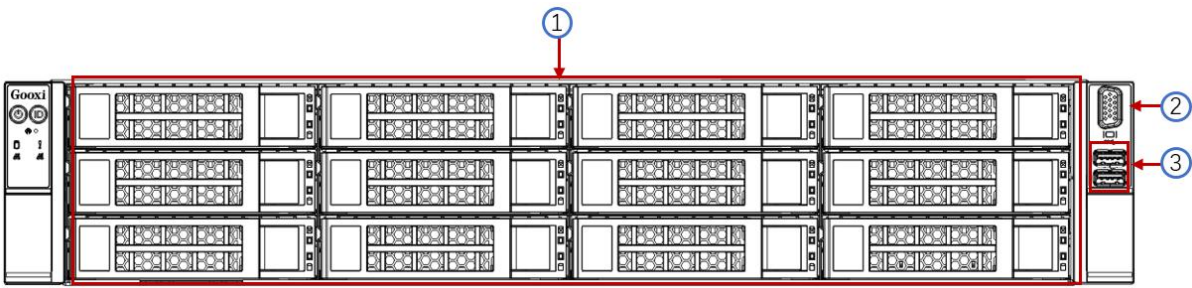

Serial number	Name	Serial number	Name
1	3.5 inch hard drive	3	USB3.0 port
2	VGA port		

Table 1- 9

2U25-bay model

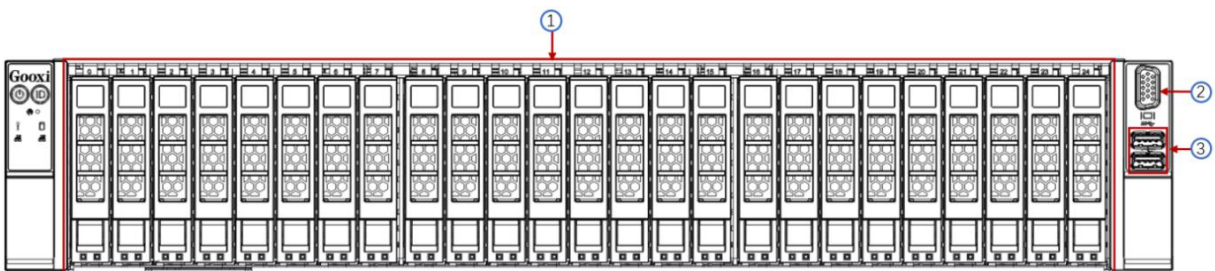

Serial number	Name	Serial number	Name
1	2.5 inch hard drive	3	USB3.0 port
2	VGA port		

4U24/36-bay model

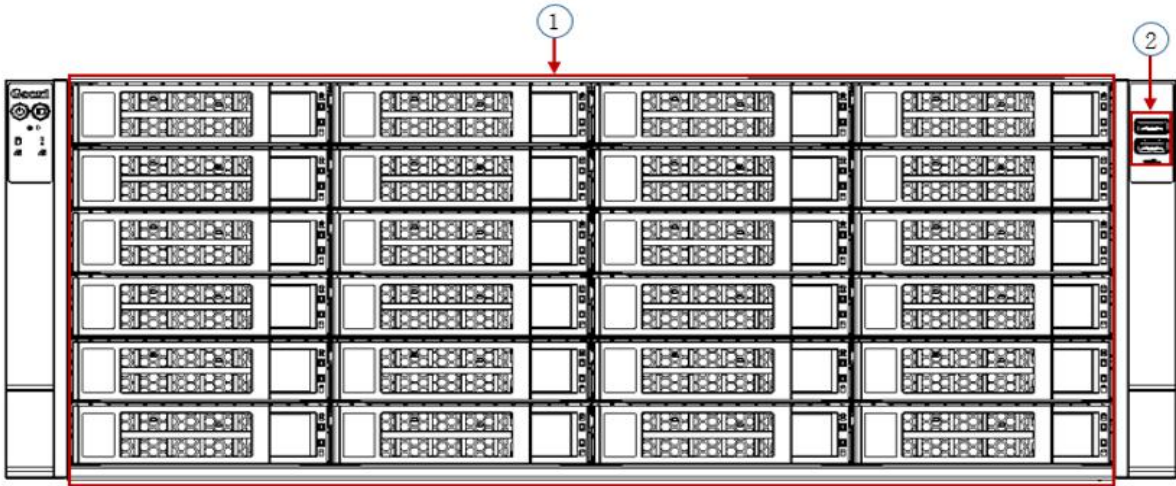

Serial number	Name	Serial number	Name
1	3.5 inch hard drive	2	USB3.0 port

Front panel port description

Name	Types of	Description
VGA port	DB15	For connecting to a display terminal such as a monitor or KVM.
USB port	USB 3.0	Provides an external USB port via which USB devices can be connected. Note: When using an external USB device, please make sure that the USB device is in good condition, otherwise the server may work abnormally.

Table 1- 11

Front Panel Indicators and Button Descriptions

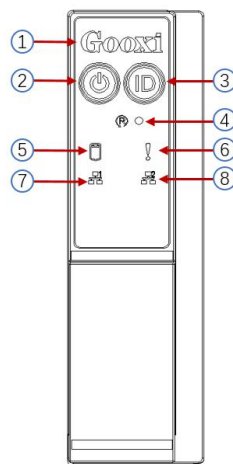

Figure 2- 8

Serial number	Indicator/Button	Serial number	Indicator/Button
1	Power switch button/indicator	5	System alarm indicator
2	UID button/indicator	6	Network port 1 connection status indicator
3	Reset restart server button	7	Ethernet port 2 connection status indicator

4	Hard disk indicator		
---	---------------------	--	--

Table 1- 12









LED Status Description		
Logo	Indicator/ Button	Status Description
		GOOXI logo
	Power Indicator	<p>Power indicator description:</p> <p>Green (steady on): Indicates that the device is powered on normally.</p> <p>Green (flashing): Indicates that the device is in standby.</p> <p>Green off: The device is not powered on.</p> <p>Power button description:</p> <p>Short press this button in the power-on state, and the OS shuts down normally.</p> <p>Press and hold the button for 6 seconds in the power-on state to forcibly power off the server.</p> <p>Short press this button in the power-on state to start the machine.</p>
	UID button/ indicator	<p>The UID button/indicator is used to conveniently locate the server to be operated. The UID button can be manually pressed or the BMC command can be remotely controlled to turn the light off or on.</p> <p>Description of UID indicator:</p> <p>Blue (steady on/flashing): Indicates that the server is located.</p> <p>Off: Indicates that the server is not located.</p> <p>UID button description: Short press this button to turn on/off the positioning light.</p>
	Reset restart server button	Press to restart the server
	Hard disk indicator	Blinking green light: The hard drive is operating normally
	System alarm indicator	System alarm indicator. Including system alarms, fan alarms, power supply alarms, etc., which can be viewed through the IPMI management software
	Network port connection status indicator	<p>Corresponds to the Ethernet port indicator of the NIC card.</p> <p>Green (steady on): Indicates that the network port is connected normally.</p> <p>Off: Indicates that the network port is not in use or is faulty.</p> <p>Note: Corresponding to the two 1GE network ports on the motherboard.</p>
	Network port connection status indicator	<p>Corresponds to the Ethernet port indicator of the NIC card.</p> <p>Green (steady on): Indicates that the network port is connected normally.</p> <p>Off: Indicates that the network port is not in use or is faulty.</p> <p>Note: Corresponding to the two 1GE network ports on the motherboard.</p>

Table 1- 13

2.4.2 Rear Panel Components

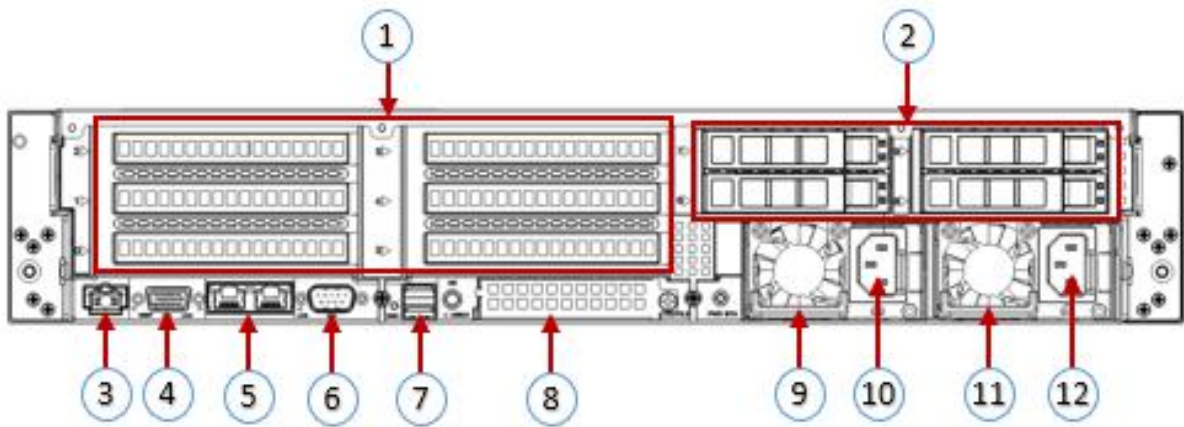

Figure 2- 9

Serial number	Name	Serial number	Name
1	Rise module	7	USB 3.0 port
2	Hard disk module	8	OCP3.0 port
3	Management network port	9	Power Module 1
4	VGA port	10	Power Module 1 AC port
5	RJ45 Gigabit Ethernet port	11	Power Module 2
6	COM port	12	Power Module 2 AC port

Table 1- 14

✧ Description:

Both 1 and 2 can be equipped with rear hard disk modules or Riser modules. This picture is for reference only, and the actual configuration shall prevail.

Rear panel port description

Name	Types of	No.	Description
VGA port	DB15	1	For connecting to a display terminal such as a monitor or KVM.
Management network port	GE BASE-T	1	Provide outgoing 1000Mbit/s Ethernet port. The server can be managed through this interface.
USB port	USB 3.0	2	Provides an outgoing USB port via which USB devices can be connected. Notice: When using an external USB device, please make sure that the USB device is in good condition, otherwise the server may work abnormally.
RJ45 Gigabit Ethernet port	GE BASE-T	2	Server service network port.
Power Module AC port	/	1 or 2	You can choose the number of power supplies according to your actual needs, but make sure that the rated power of the power supply is greater than the rated power of the whole machine.
COM port		1	Serial communication port
OCP3.0 port		1	Install the network card of OCP3.0

Table 1- 15

Rear Panel Indicators and Button Descriptions

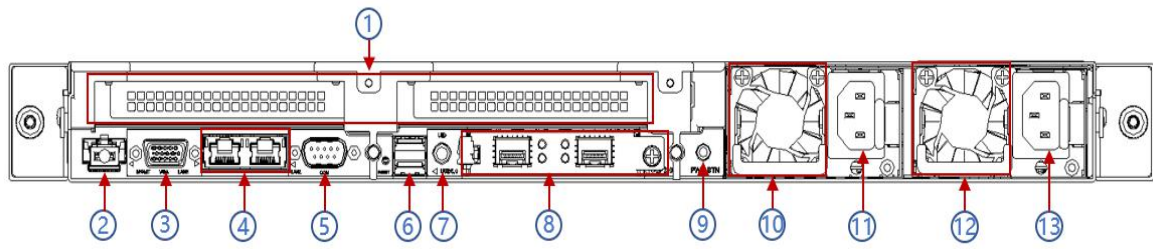

Serial number	Name	Serial number	Name
1	Riser module	8	OCP3.0 port
2	Management network port	9	Power switch button
3	VGA port	10	Power Module 1
4	RJ45 Gigabit Ethernet port	11	Power module AC port 1
5	COM port	12	Power Module 2
6	USB 3.0 port	13	Power module AC port 2
7	UID indicator		

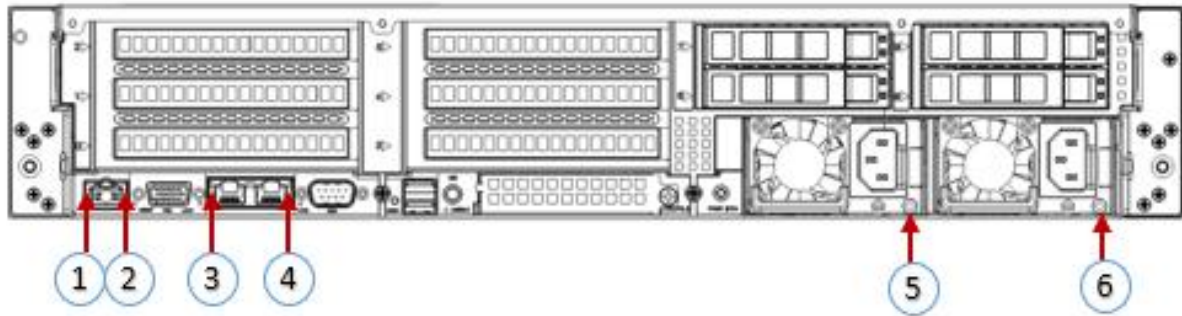

Figure 2- 10

Serial number	Name	Serial number	Name
1	Connection status indicator	4	Data transfer status indicator
2	Data transfer status indicator	5	Power Module Indicators
3	Connection status indicator	6	Power Module Indicators

Table 1- 16

Rear panel port description

Name	Types of	No.	Description
VGA port	DB15	1	For connecting to a display terminal such as a monitor or KVM.
Management network port	GE BASE-T	1	Provide outgoing 1000Mbit/s Ethernet port. The server can be managed through this interface.
USB port	USB 3.0	2	Provides an outgoing USB interface through which USB devices can be connected. Notice: When using an external USB device, please make sure that the USB device is in good condition, otherwise the server may work abnormally.

RJ45 Gigabit Ethernet port	GE BASE-T	2	Server service network port.
Power Module AC port	/	1 or 2	You can choose the number of power supplies according to your actual needs, but make sure that the rated power of the power supply is greater than the rated power of the whole machine.
COM port		1	Serial communication port
OCP3.0 port		1	Install OCP3.0 network card

Indicator/ Button	Status Description
Power Module Indicators	<p>Green (steady on): Indicates that the input and output are normal.</p> <p>Red (steady on): Indicates that the input is normal, and there is no output due to power supply over-temperature protection, power output over-current/short-circuit, output over-voltage, short-circuit protection, device failure (excluding all device failures) and other reasons.</p> <p>Green (1Hz/flashing): Indicates that the input is normal, the power supply is turned off due to power-on or in-position; the input is over- or under-voltage.</p> <p>Green (4Hz/flashing): indicates that the firmware is being upgraded online.</p> <p>Off: Indicates that there is no AC power input.</p>
Connection status indicator	<p>Steady green: Indicates Gigabit Link.</p> <p>Steady orange: Indicates 100M link.</p> <p>Off: Ten Mega Links.</p>
Data transfer status indicator	<p>Yellow (flashing): Indicates that data is being transmitted.</p> <p>Off: Indicates no data transmission.</p>
UID indicator	<p>Blue (steady on/flashing): Indicates that the server is located.</p> <p>Off: Indicates that the server is not located.</p> <p>UID button description: Short press this button to turn on/off the positioning light.</p>
OCP network port indicator	The upper two are connection status indicators, and the lower two are data transmission status indicators
Power Button	<p>Short press this button in the power-on state, and the OS shuts down normally.</p> <p>Press and hold the button for 6 seconds in the power-on state to forcibly power off the server.</p> <p>Short press this button in the power-on state to start the machine.</p>

Table 1- 17

2.4.3 Motherboard Components

All models share motherboard components, the port description is as follows

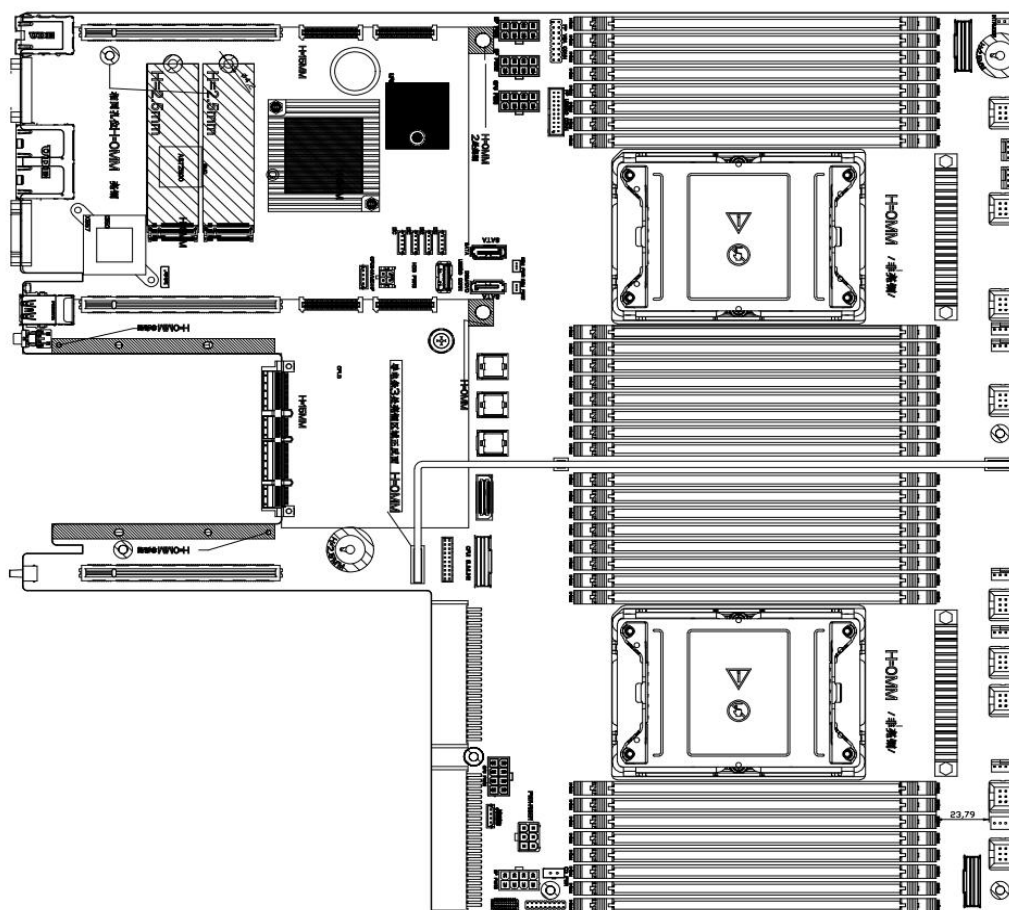

Name	Remarks	Default
J16	BMC_UART5, BMC debug serial port	
PJ1	Used for CPU0 VR upgrade and programming, the jumper cap is not connected by default	
PJ2	For CPU1 VR upgrade and programming, the jumper cap is not connected by default	
J12	Front VGA mounting ear connector	
J36	Front USB 3.0 connectors (x2)	
J35	Built-in USB3.0 connector	
J34	Rear USB3.0 connector q(x2)	
J1	Trusted Platform Module (TPM)	SPI
SSD1 / SSD2	M.2 PCIE X2 CONN, only supports PCIe Only 2280 size	
J15	CPLD JTAG Header, used to program CPLD program	
J32	Front panel buttons, LED connectors	
J48	2X10 BP HDD LED Connector (for Rear HDD BP backplane)	
J27	sSATA, SATA 3.0 Connection from PCH (8643 miniSAS HD with PCH sSATA SGPIO Pins) * Nebulas 3 Ver.A motherboard must use J27 and J48 to connect RM2112-SHDB-D1 /D2 to turn on the hard drive light*	
J29	SATA, SATA 3.0 Connection from PCH (8643 miniSAS HD with PCH SATA SGPIO Pins)	
J31	SATA, SATA 3.0 Connection from PCH (8643 miniSAS HD with PCH SATA SGPIO Pins)	

FAN1~FAN9	6 P in fan connector (total 9 pcs)	
J40~J47	4 P in fan connector (total 8 pcs)	
SATA1/SATA2	SATA DOM CONN (SATA 7 Pin) (with PWR design)	
J37/J38	SATA DOM PWR CONN	
J64	Chassis Intrusion Header, Chassis Intrusion Detection	
J24/J25	Slimline PCIe X 8 CONN (defined by SFF-9402 standard)	
B1	Buzzer	
DIMMA0-DIMMH0 DIMMA1-DIMMH1	CPU0 DIMM , 16 Slots	
DIMMA3-DIMM H3 DIMMA4-DIMM H4	CPU1 DIMM, 16 Slots	
SW3	Rear BMC Reset Button	
COM1	Rear COM Port	
J4	Rear BMC IPMI LAN Port	
J2	1X2 Gigabit data network port	
CN1	Rear VGA Connector	
SW2	Rear UID Button (Blue LED)	
SW1	Rear Power Button	
J51/J53/J56/J58	2X4 Front BP HDD Power Connectors (White)	
J59/J61	2X4 Risers and GPU Card Power Connectors (Black)	
J52/J54/J55	2X2 Rear BP HDD Power Connectors (Black)	
J60	2X3 Riser 4 Power Connector (Black)	
J69	PEHP CPU0 (1.8V CPU I2C Reserved for U.2 HDD backplane)	
J70	PEHP CPU1 (1.8V CPU I2C Reserved for U.2 HDD backplane)	
J49/J50	CRPS Slots	
SW4	SKU IDs (Reserved)	
J7/J8/J9/J10	BP1~BP4 BMC I2C Connector (Reserved for HDD BP backplane)	
J57	1X2 CD/DVD Power Connector	
J63	NVME Key(VROC)	
J13	VR Debug Mode Jump (Reserved for RD test Only)	No Jumper
J14	CPLD No CPU Power ON Jump (Reserved for RD test Only)	No Jumper
J30	2X4 SATA sGPIO Header (for 8643 miniSAS HD Conn J29/J31)	
J28	2X4 sSATA sGPIO Header (for 8643 miniSAS HD Conn J28)	
J33	BMC Watch Dog Timer Enable (Reserved for RD test Only)	
J5	IPMB Connector	
J67	SCY Strap , (2/3)High = Disable Flash Descriptor Security	Default (1/2)Low
J11	PCH_HOST I2C Header (Reserved for RD test Only)	

J68	PCH I2C Header Pin.1/2 Clear CMOS Pin.3/4 Password Clear Pin.5/6 ME FW Recovery Status Pin.7/8 BMC Disable Pin.9/10 BIOS Recovery Mode Enable	No Jumpers
J3	SD Card Slot (BMC Log Storage)	
OCP1	OCP3.0 Slot (CPU0 PCIE X8)	
J17+J18+J19	Riser1 Slot (CPU0 PCIE X32)	
J20+J21+J22	Riser2 Slot (CPU0 PCIE X32)	
J23	Riser3 Slot (CPU1 PCIE X16)	

2.4.4 HDD Backplane Components

1U4 direct connection backplane as shown in the figure

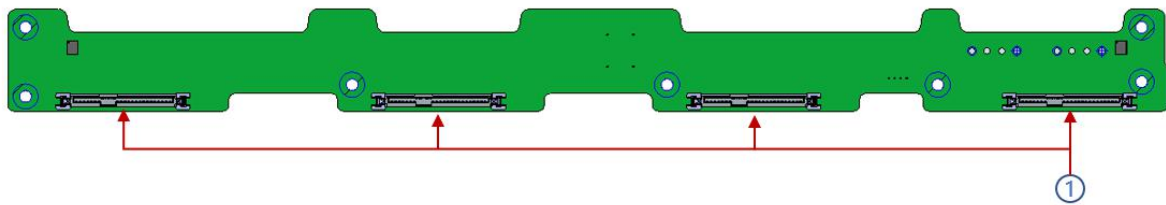

Serial number	Description	Function
1	SAS/SATA hard drive connector	1. Maximum support 12G/b SAS hard disk; 2. Maximum support 6G/b SATA hard disk; 3. Support SAS/SATA hard disk hot-swap.

1U10 expansion backplane:

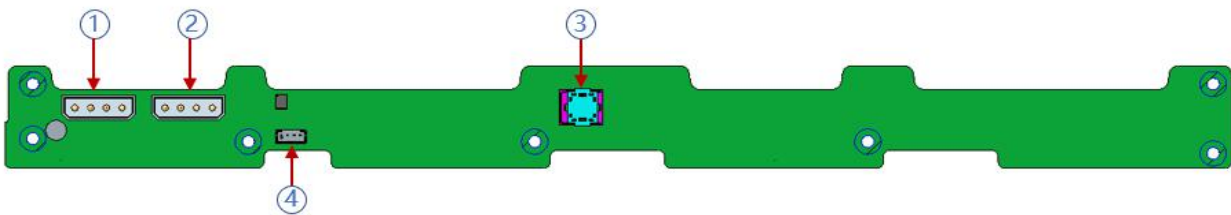

Serial number	Description	Function
1, 2	Power connector	Backplane power transfer connector for 5V/12V power transfer
3	SFF-8643 12Gb SAS interface	Backplane bay signal interface
4	I2C port	For I2C signal interface

2U8 expansion backplane as shown

TOP view:

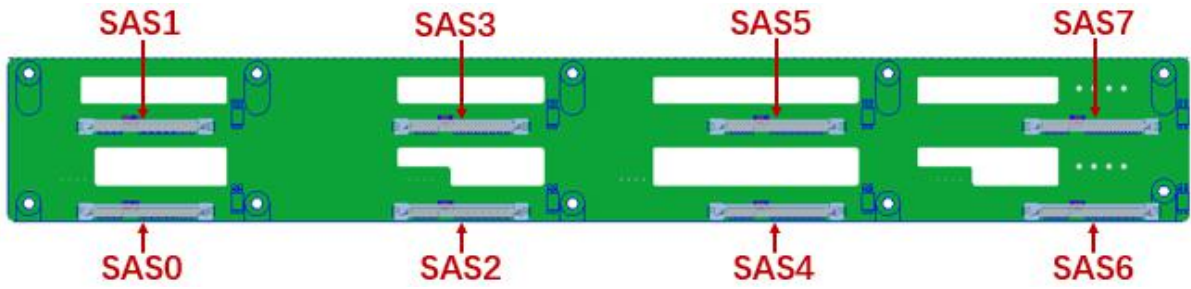

Serial number	Description	Function
SAS0~7	SAS/SATA hard drive connector	1. Maximum support 12G/b SAS hard disk; 2. Maximum support 6G/b SATA hard disk; 3. Support SAS/SATA hard disk hot-swap.

Bottom view:

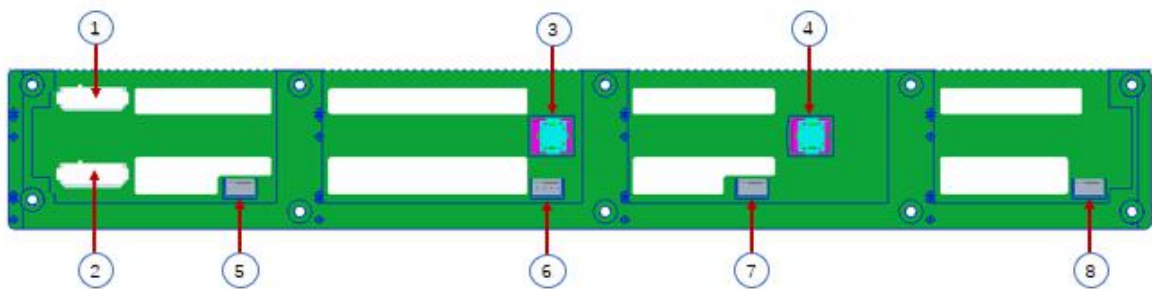

Serial number	Description	Function
1, 2	ATX power input	Backplane power transfer connector for 12V power transfer
3, 4	SFF-8643 12Gb SAS port	Backplane bay signal port
5, 6, 7, 8	Temperature Controlled Fan Socket	For 4pin fan port

2U12 expansion backplane as shown

TOP view:

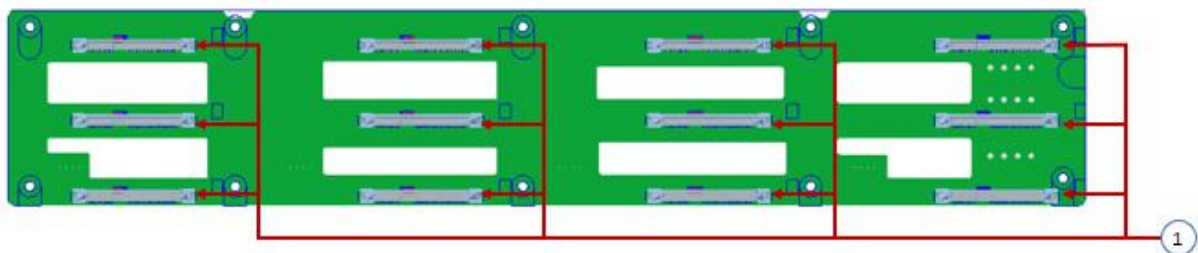

Serial number	Description	Function
1	SAS/SATA hard drive connector	1. Maximum support 12G/b SAS hard disk; 2. Maximum support 6G/b SATA hard disk; 3. Support SAS/SATA hard disk hot swap.

Bottom view:

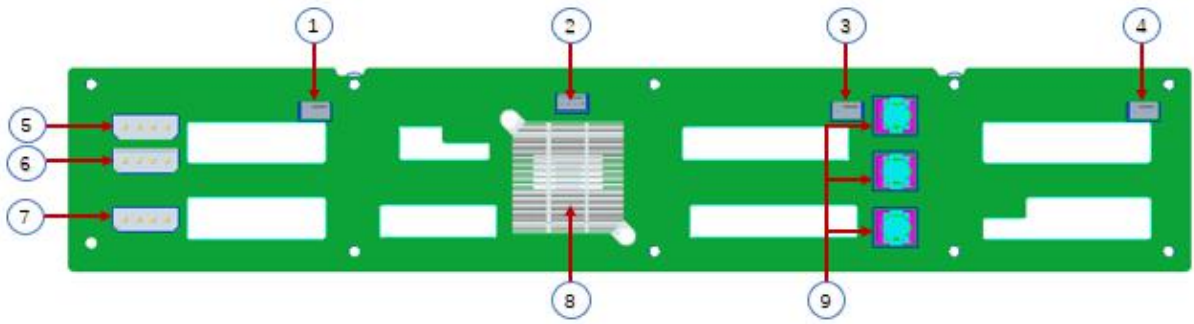

Serial number	Description	Function
1, 2, 3, 4	Temperature Controlled Fan Socket	For 12G/b SAS or 6G/b SATA signal transmission.
5, 6, 7	Power connector	Backplane power transmission connector for 12V power transmission.
8	EXPANDER chip	PM8043 SXP 24Sx12G 24-port 12G SAS Expander
9	MINI SAS HD High Speed Connector	For 12G/b SAS or 6G/b SATA signal transmission.

2U25 expansion backplane as shown

TOP view:

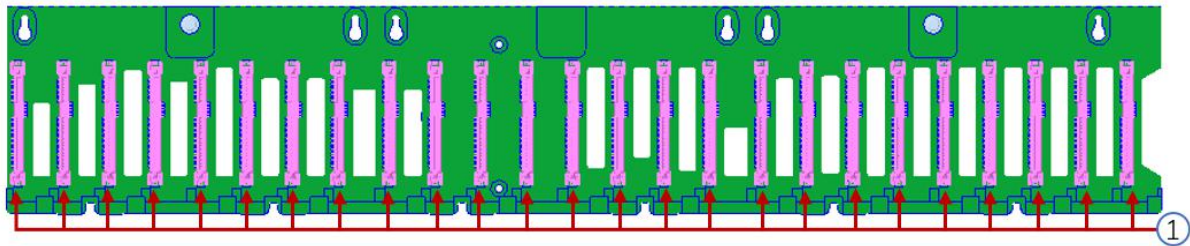

Serial number	Description	Function
1	SAS/SATA hard drive connector	1. Maximum support 12G/b SAS hard disk; 2. Maximum support 6G/b SATA hard disk; 3. Support SAS/SATA hard disk hot swap.

Bottom view:

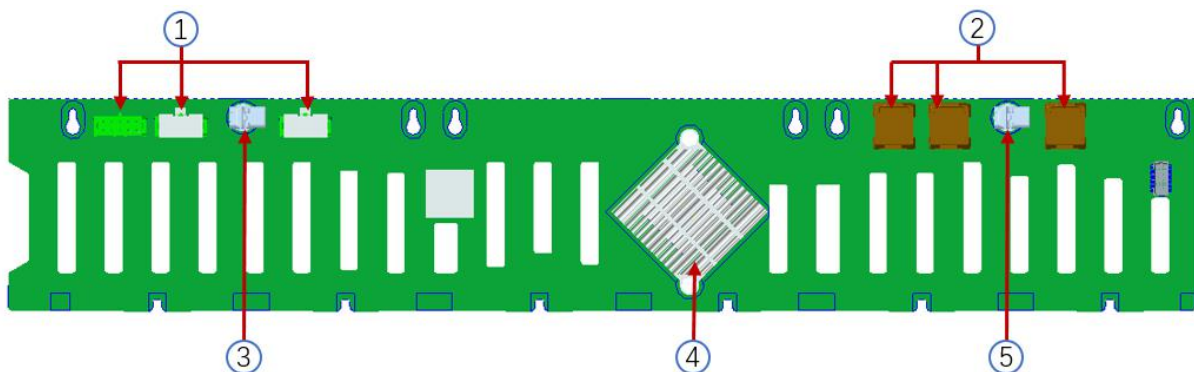

Serial number	Description	Function
1	Power connector	Backplane power transfer connector for 12V power transfer

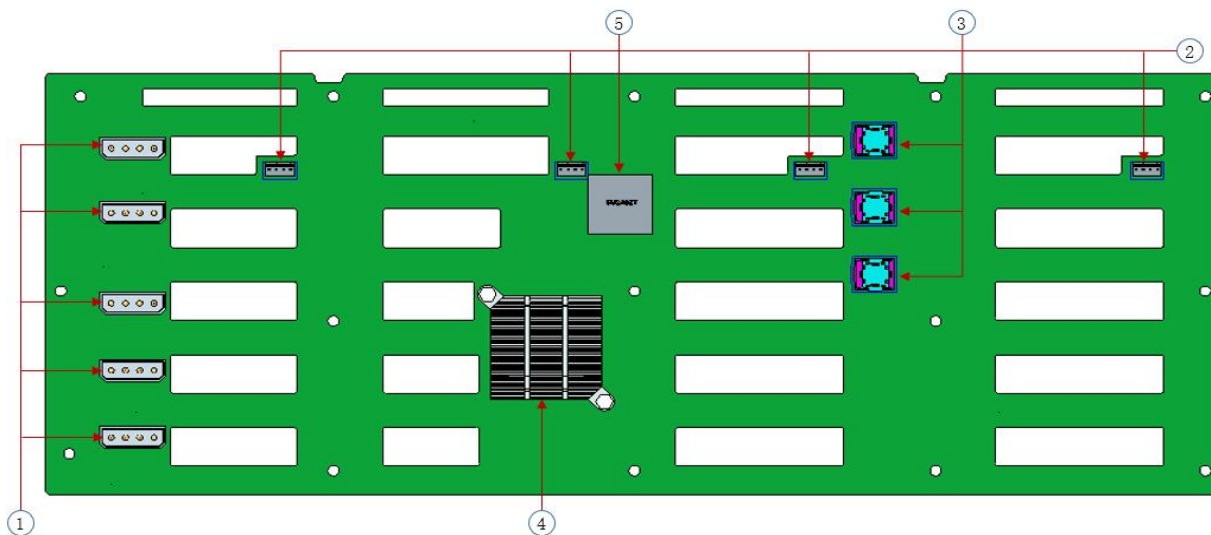

2	MINI SAS HD High Speed Connector	For 12G/b SAS or 6G/b SATA signal transmission
3.5	Backplane Snap	Fasten the backplane to the backplane bracket
4	EXPANDER chip	PM8043 SXP 24Sx12G

24-bay expansion backplane as shown

Serial number	Description	Function
1	BP power interface	Backplane power transfer connector for 12V and 5V power transfer
2	Fan interface	For 4pin fan interface
3	SFF-8643 12Gb SAS port	For 12G/b SAS or 6G/b SATA signal transmission
4	Expander Chip Controller	PM8043 SXP 24Sx12G 24-port 12G SAS Expander
5	CPLD	For data logic processing

Rear SAS/SATA backplane as shown

TOP view:

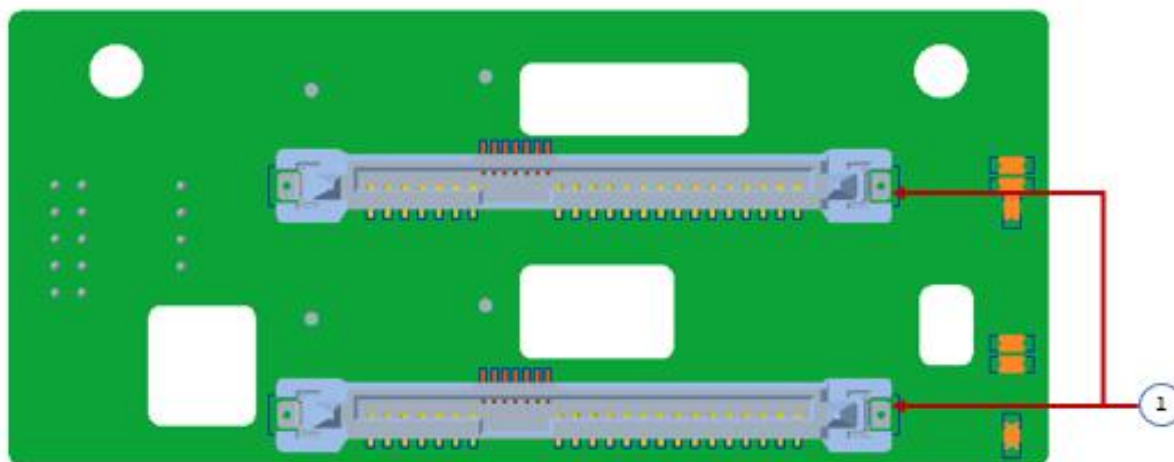

Figure 2- 18

Serial number	Description	Function
---------------	-------------	----------

1	SAS/SATA connector	1. Maximum support 12G/b SAS hard disk; 2. Maximum support 6G/b SATA hard disk; 3. Support SAS/SATA hard disk hot swap.
---	--------------------	-------------------------------------------------------------------------------------------------------------------------------

Table 1- 24

Bottom view:

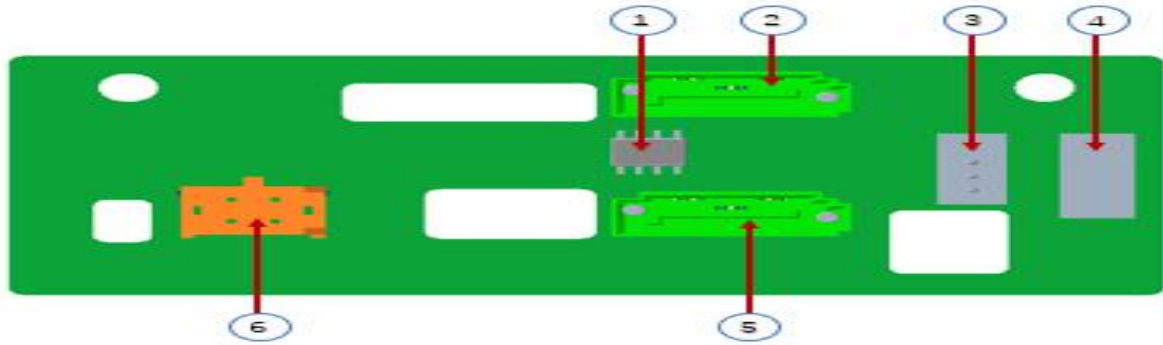

Serial number	Description	Function
1	Temperature sensor IC	Temperature sensor chip
2, 5	7PIN SATA port	SATA disk signal line port
3	I2C port	For I2C signal port
4	SGPIO lighting signal	Used for hard disk LED positioning lighting and fault LED indication functions.
6	Power port	Backplane power transfer connector for 12V power transfer

U.2 backplane as shown

TOP view:



Figure 2- 20

Serial number	Description	Function
1	SFF-8639 Connector	U.2 port supporting PCIe×4 for connecting to NVME SSD

Bottom view:

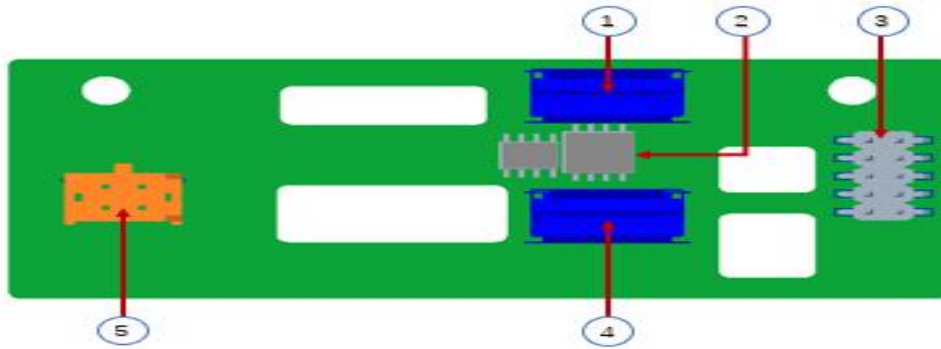

Serial number	Description	Function
1, 4	Slimline 4i Connector	Provides PCIe×4 interface to connect to CPU and NVME SSD1 (including CPU PEHP I2C and BMC I2C signals)
2	CPLD chip	For data logic processing
3	JATG debugging interface	JTAG debug interface for programming and version upgrade of CPLD
5	Power outlet	4 Pin power socket for docking with PSU or docking with MB 4 Pin plug to power the board

OCP3.0 network card as shown in the figure

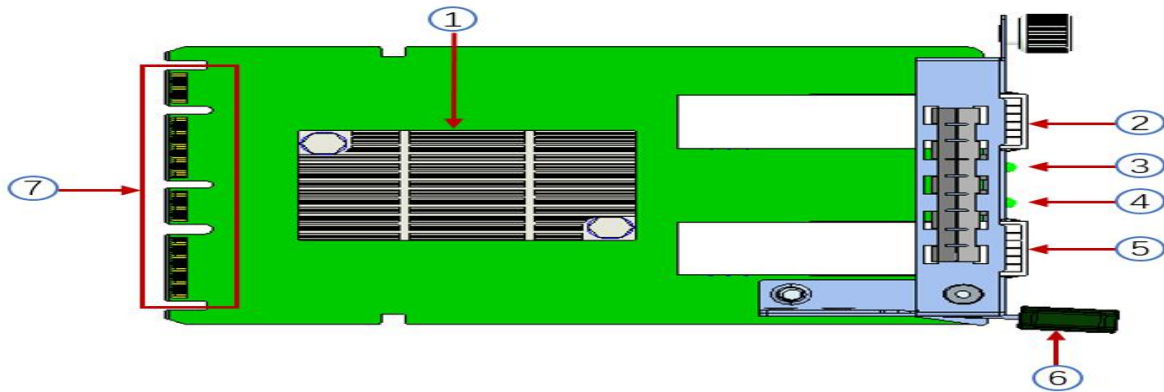

Serial number	Description	Function
1	Intel 82599ES chip	Mainly connected to the network port controller of the motherboard CPU via PCIe Gen2 X8, which is converted into a 2-port optical port SFP+ at the network card end, and the 82599ES chip also provides a port for communication with motherboard BMC NCSI for info transfer between BMC & NIC.
2	SFP+ LAN1	Provide SFP+ 10G optical port signal
3	LED1	LED status indicator
4	LED2	LED status indicator
5	SFP+ LAN2	Provide SFP+ 10G optical port signal
6	Network card buckle	It is used to lock the network card. When removing the network card, you need to press down to pull out the network card.
7	OCP3.0 port	Used to connect to the motherboard OCP3.0 PCIe X8 signal/12V power supply/Sideband signal

LED Indicator Description

Serial number	Description	Function
LED1	SFP+ LAN1 Link LED	Green/ yellow indicator for indicating LAN1 speed Green: 10 Gigabit Internet speed ; Yellow : Gigabit Internet speed No light: no optical port network cable
	SFP+ LAN1 ACT LED	Green light for LAN1 data activity Flashing: data activity ; off: no data activity
LED2	SFP+ LAN2 Link LED	Green/ yellow indicator for LAN2 speed Green: 10 Gigabit Internet speed; Yellow : Gigabit Internet speed No light: no optical port network cable
	SFP+ LAN2 ACT LED	Green light for LAN2 data activity Flashing: data activity; off: no data activity

RISER 1 backplane as shown:

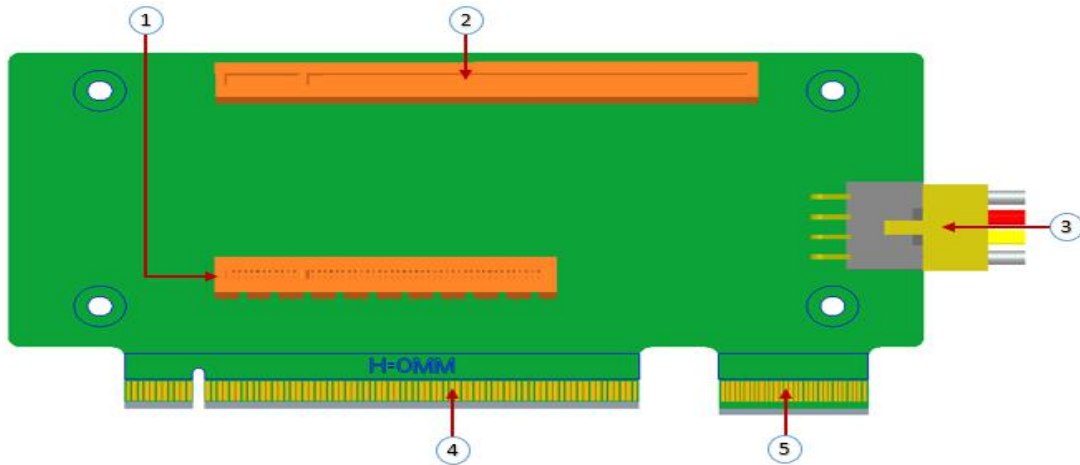

Serial number	Description	Function
1	PCIe 3.0 X8 Slot	For PCIe 3.0 X8 devices.
2	PCIe 3.0 X16 Slot	For PCIe 3.0 X16 devices.
3	RISER POWER	Riser card power transmission connector for 12V power transmission
4	PCIe X16 Specification Gold finger	For motherboard PCIe X16 X8 port
5	PCIe X8 specification gold finger	For motherboard PCIe X16 X8 port

RISER 2 backplane as shown:

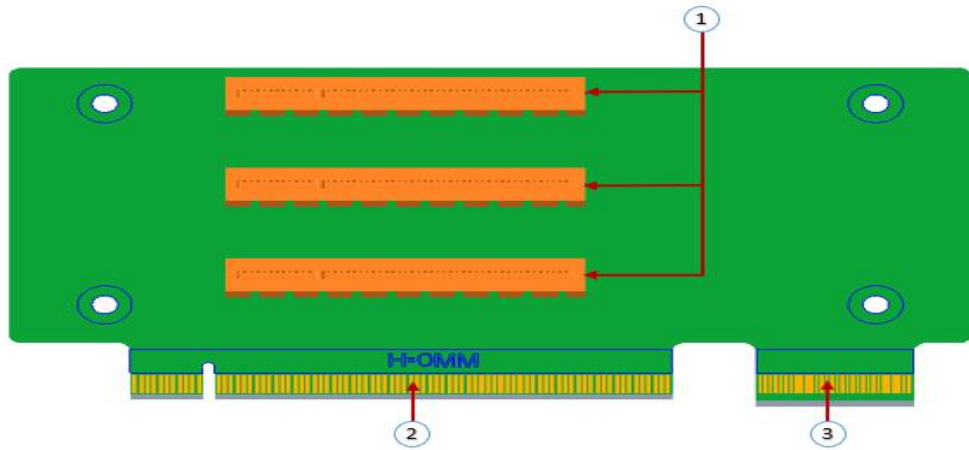

Serial number	Description	Function
1	PCIe 3.0 X8 Slot	For PCIe 3.0 X8 devices.
2	PCIe X16 Gold finger	For motherboard PCIe X16 X8 port
3	PCIe X8 Gold Finger	For motherboard PCIe X16 X8 port

RISER 3 backplane as shown

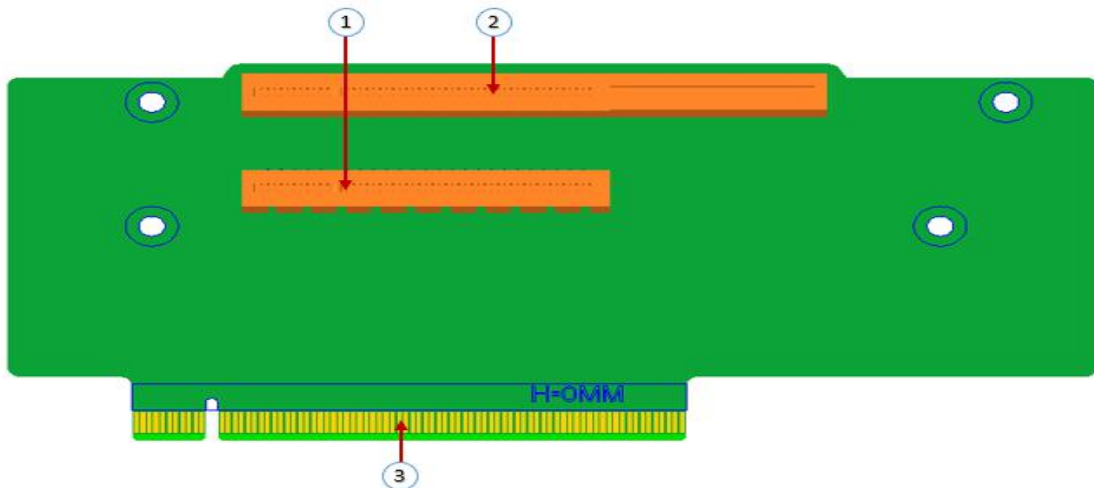

Serial number	Description	Function
1	PCIe X16 Slot	For PCIe 3.0 X16 devices.
2	PCIe X8 Slot	For PCIe 3.0 X8 devices.
3	PCIe X16 Specification Gold finger	For motherboard PCIe X16 port

RISER 4 backplane as shown

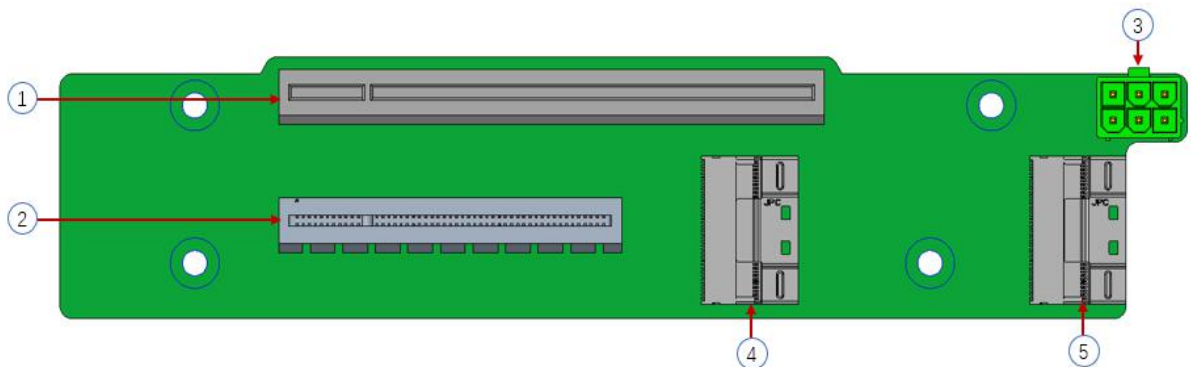

Serial	Description	Function
--------	-------------	----------

number		
1	PCIe X16 slot	For PCIe 3.0 X16 devices.
2	PCIe X8 slot	For PCIe 3.0 X8 devices.
3	Power port	Riser card power transmission connector for 12V power transmission
4.5	Slimline port	For connecting Slimline cables

2.4.5 DIMM slot locations

The motherboard adopts Intel Whitley platform and is equipped with Intel Xeon ICE Lake CPU. Each CPU supports 8 Channels, and each Channel has 2 DIMMs. The entire board can support 32 DIMMs. When only one memory is inserted , the blue box in the figure below is preferred. Inner slot board slot plastic color is blue), supports DDR4 ECC RDIMMs/ LRDIMMs server memory, the memory frequency supports 2133 /2400/2666/2933 / MHz; the location is as shown below:

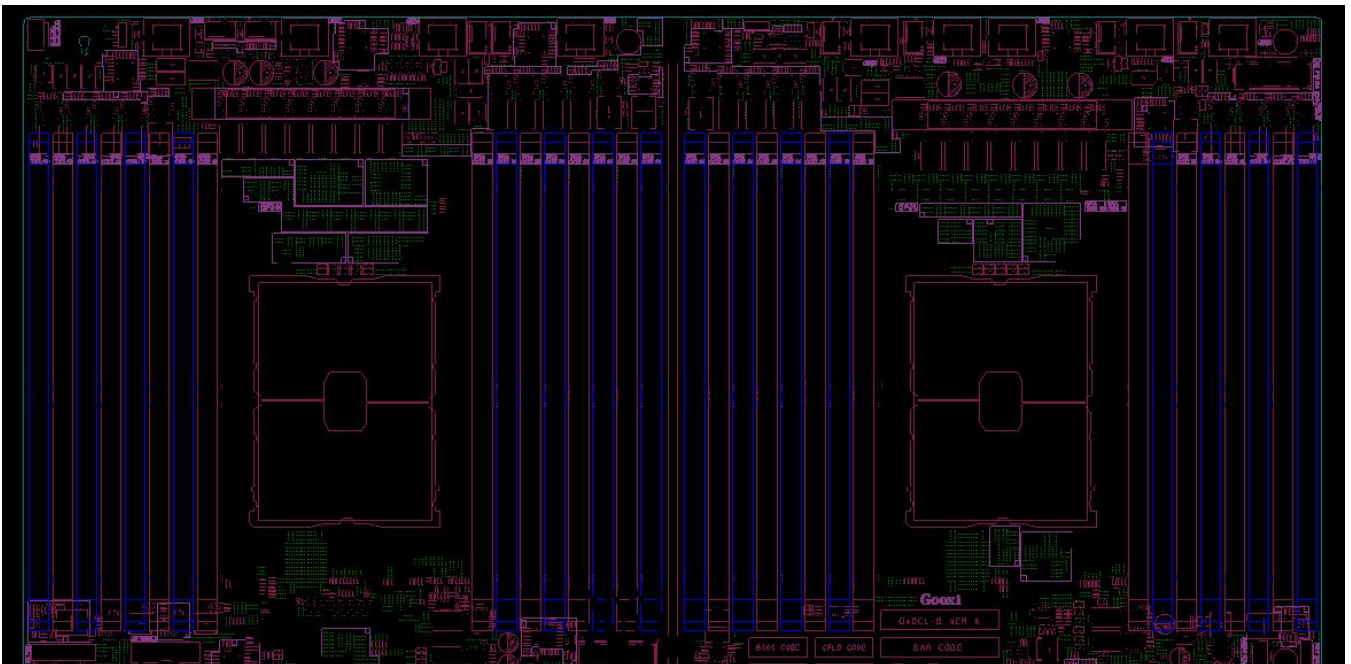

2.4.6 Hard disk label

2U8-bay model

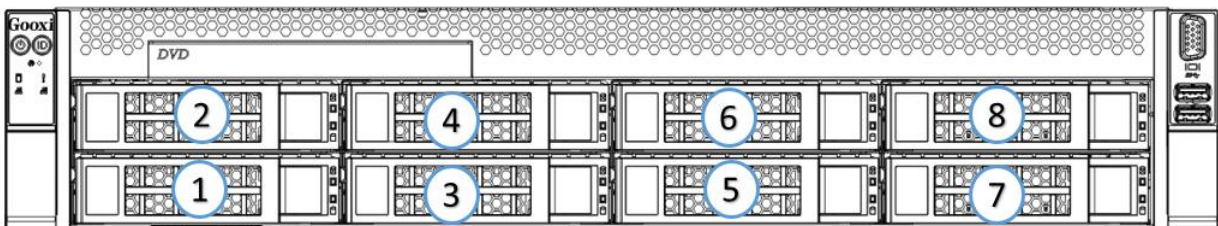

Figure 2- 28

2U12-bay model



Figure 2- 29

2U25-bay model

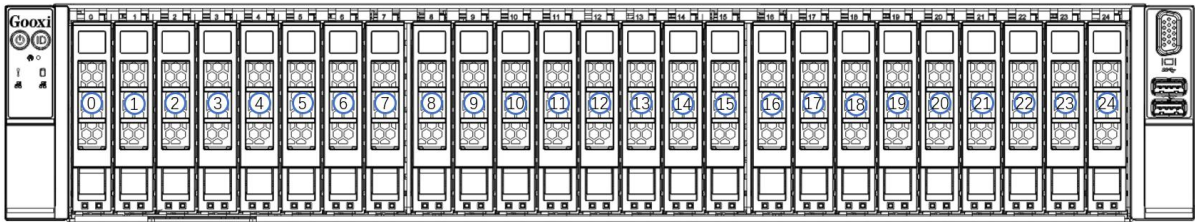

Figure 2- 30

2.4.7 Hard disk indicator

2U8/2U12 hard disk indicator

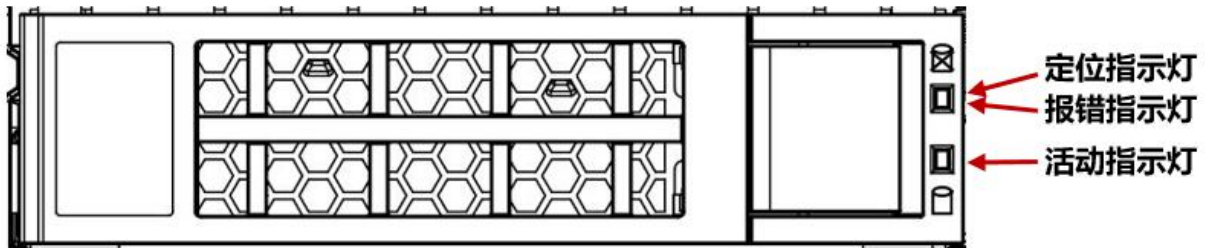

Figure 2- 31

Function	Activity indicator (green)	Location indicator (blue)	Error indicator (yellow)
Hard drive in place	Always bright	OFF	OFF
Hard drive activity	Flashing 4Hz/sec	OFF	OFF
Hard disk positioning	Always bright	Flashing 4Hz/sec	OFF
hard disk error	Always bright	OFF	Always bright
RAID rebuild	Always bright	OFF	Blink 1Hz/sec

Table 1- 34

2U 25-bay hard disk indicator

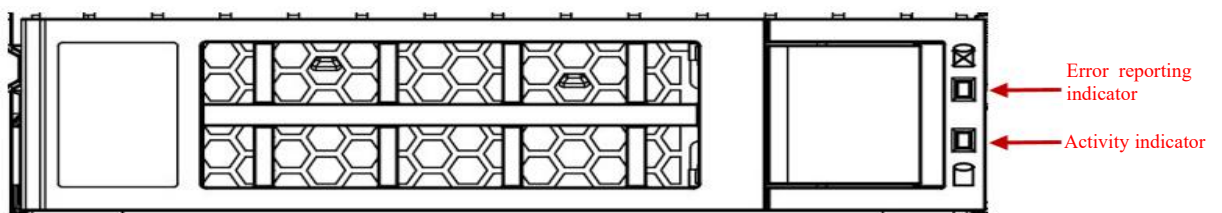

Figure 2- 32

Hard disk status	Activity indicator (green)	Error indicator (yellow)
Hard drive not in place	OFF	OFF
Hard drive is present, but no data activity	ON	OFF
The hard drive is present and active	The flicker frequency of the hard disk itself	OFF
Hard drive failure	N/A	ON
Hard drive is located	N/A	4Hz flicker

Hard disk in Rebuild state	N/A	1Hz flicker
----------------------------	-----	-------------

Table 1- 35

2.4.8 System Fan

The server supports variable fan speeds. Normally the fan runs at the lowest speed, if the server temperature rises, the fan will increase the speed to cool down.

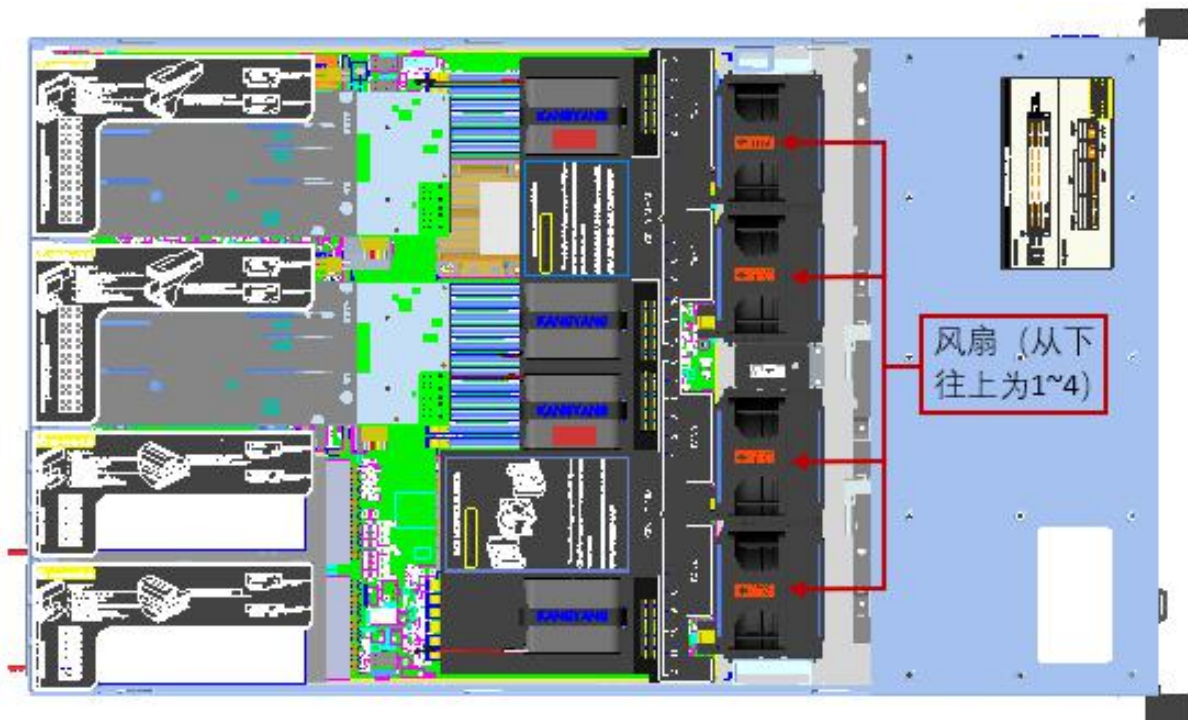

Figure 2- 33

Chapter 3 Installing System Components

3.1 Installation of CPU

Install the processor:

Step 1: CPU Installation

1. Tilt the CPU angle as shown in the figure, align the A1 corner (triangle mark), and clamp it on one end of the clamping piece.
2. Direction, press the other end of the clamping piece to fix the CPU to the clamping piece.

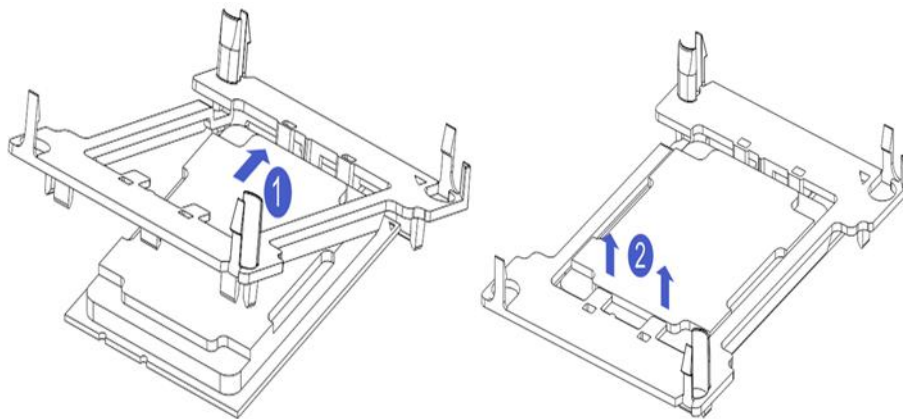

Figure 3-1

Step 2: Install the CPU on the heat sink, and ensure that the surface of the CPU and heat sink is clean and free of oil and foreign matter. (As shown below)

1. Smear about 0.4ml of thermal grease on the CPU and smooth it evenly.
2. Align the A1 corner (triangle mark), and buckle the CPU on the heat sink.

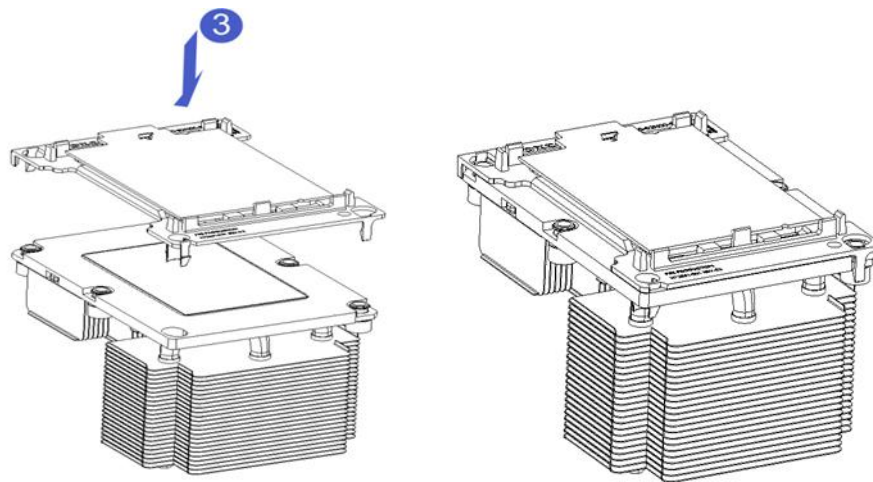

Figure 3-2

3.2 Installation of heat sink

installation steps:

1. Remove the processor blank (as shown in the figure below)

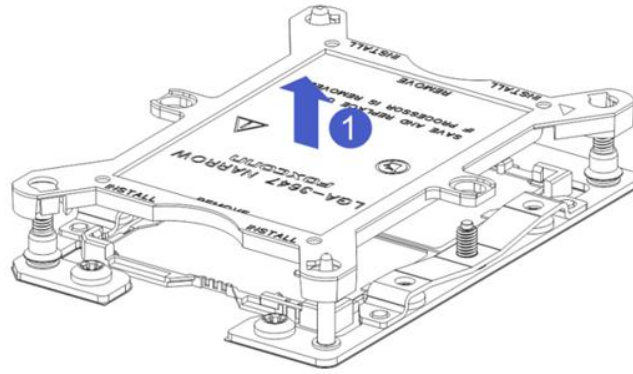

Figure 3- 1

2. Align the heat sink with the heat sink fixing studs on the CPU base, and tighten the heat sink fixing screws in sequence according to the instructions. (As shown below)

NOTE: The pins on the motherboard are extremely fragile and easily damaged. To avoid damaging the motherboard, do not touch the processor or processor socket contacts.

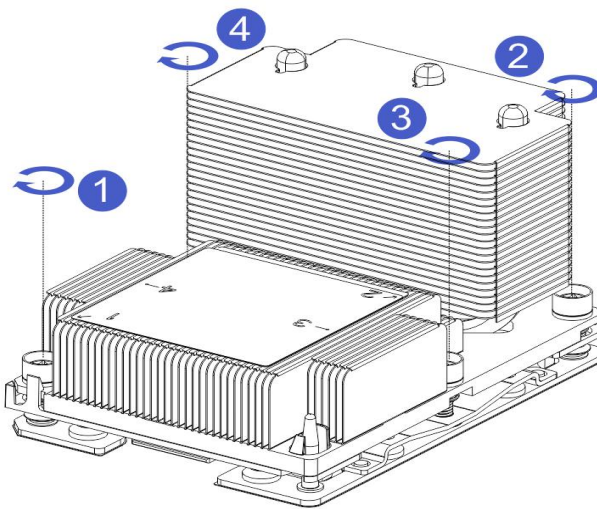

Figure 3- 2

3.3 Memory installation

3.3.1 Memory Support Specifications

The motherboard supports 64GB R-DIMM, 128GB LR-DIMM, 256GB 3DS LRDIMM DDR4 memory, up to 3200 MHz (2933MT/s is only achieved with a single memory per channel, depending on the CPU SKU).

Note: Please use memory modules with the same CAS delay value on this motherboard. It is recommended that you use the same capacity and the same frequency memory produced by the same manufacturer.

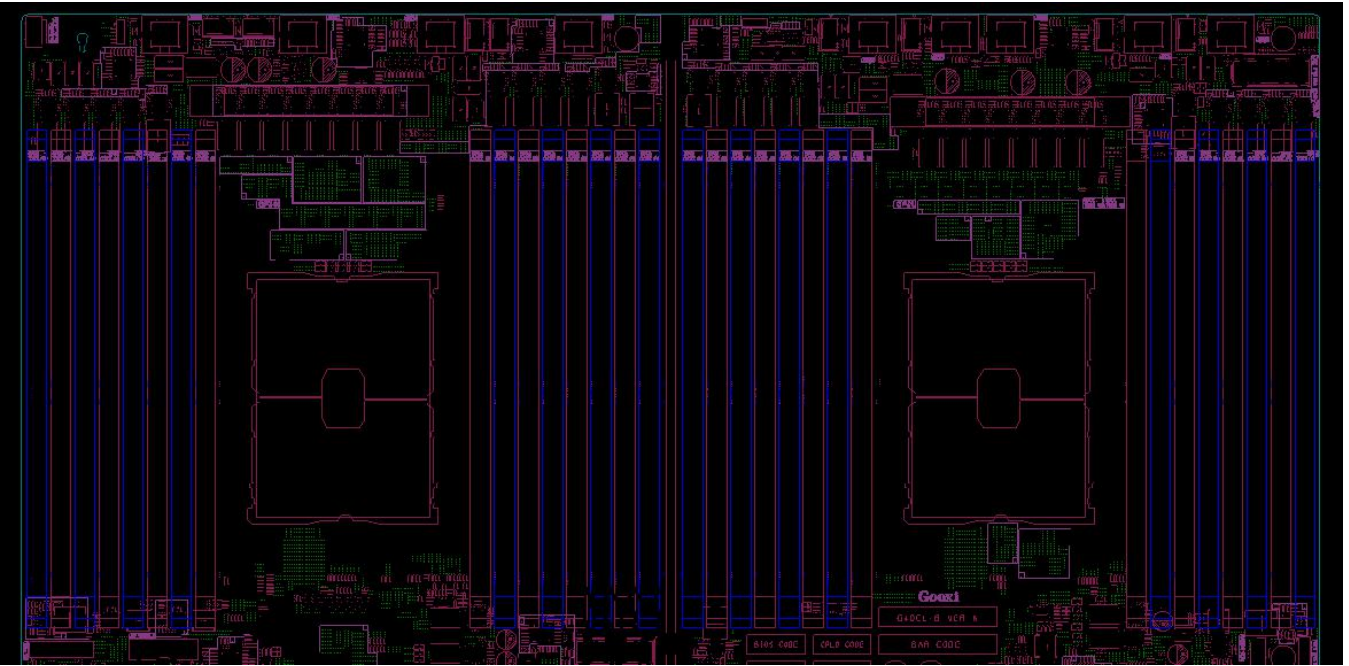

3.3.2 How to install memory

The 8 memory slots controlled by CPU 1 on the motherboard are: DIMMA1, A2, DIMMB1, B2, DIMM C1, C2 and DIMM D1, D2; the 8 memory slots controlled by CPU 2 are: DIMME1, E2, DIMMF1, F2, DIMMG1, G2 and DIMMH1, H2, pay attention to the notch of the memory and the notch of the DIMM slot, and snap each DIMM module into place vertically to prevent incorrect installation.

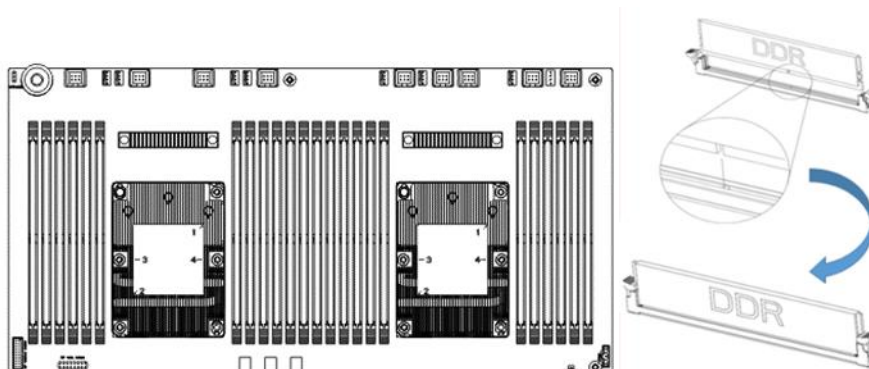

Figure 3- 3

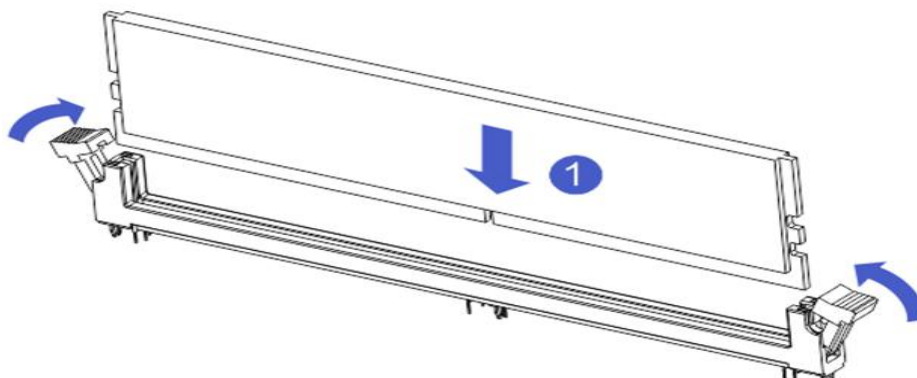

Figure 3- 4

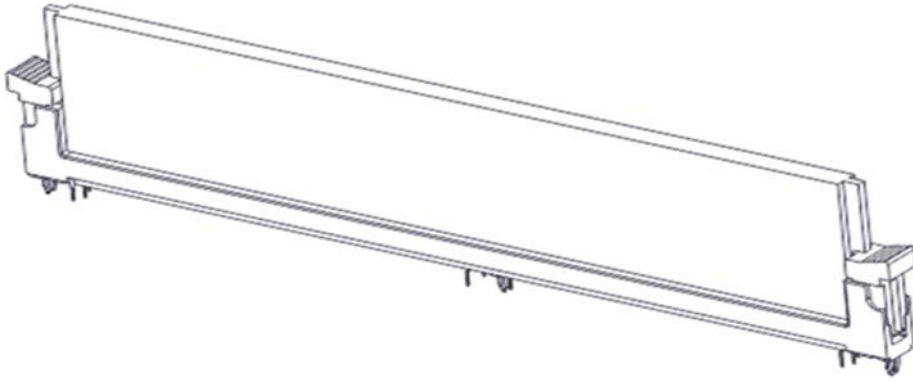

Figure 3-5

3.4 Hard disk installation

Install 3.5" hard drive:

1. Put the hard disk in the tray
2. There are 4 countersunk head screws on the left and right sides to lock the hard disk (the screw heads must not protrude from the surface of the slide rail on both sides of the tray)

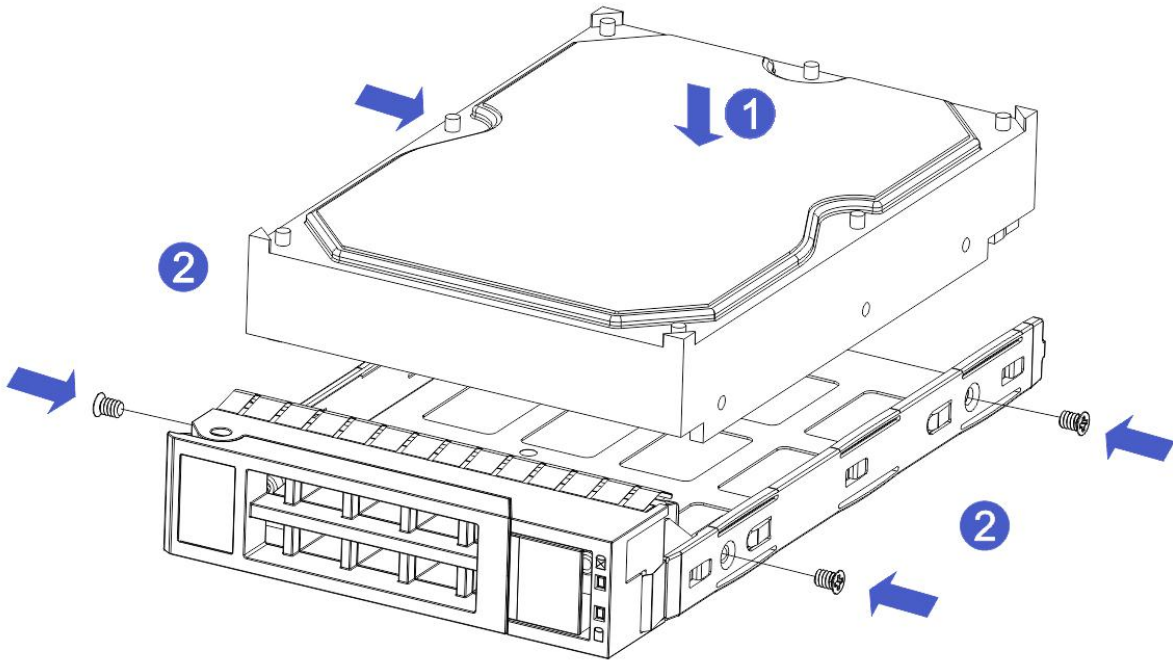

Figure 3- 6

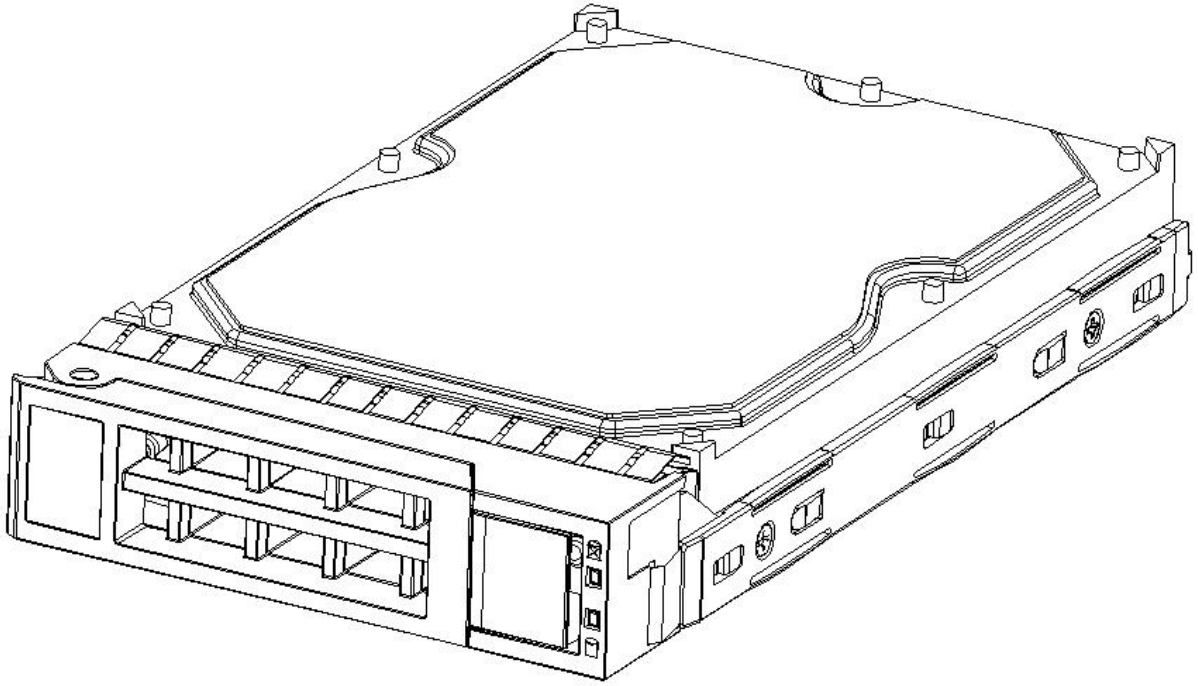

Figure 3- 7

Install 2.5" hard drive

1. Put the hard disk in the tray
2. Four countersunk head screws at the bottom lock the hard disk (the screw heads protrude from the bottom of the tray)

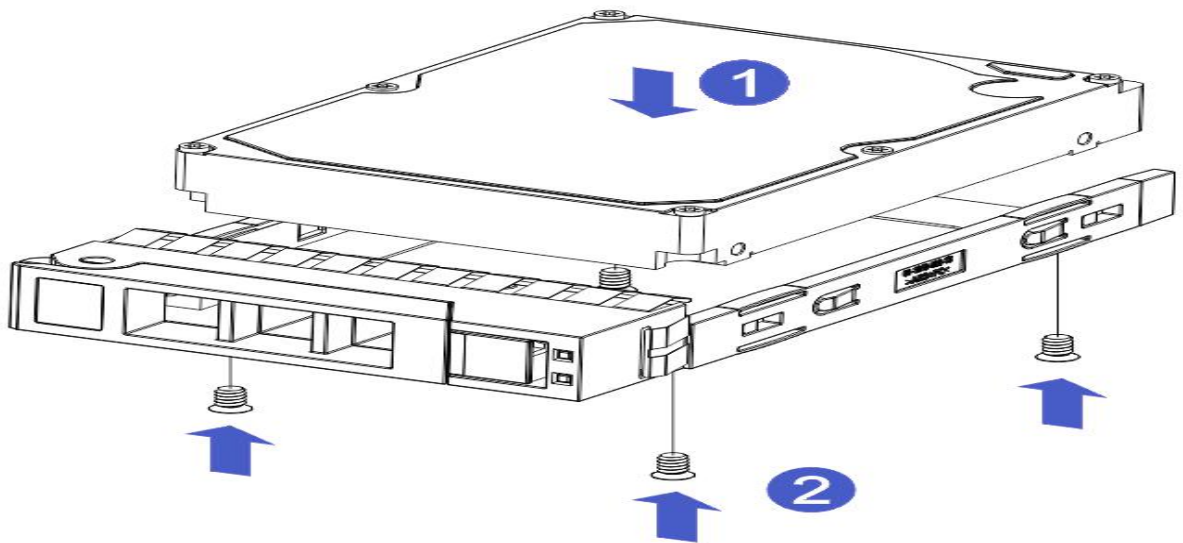

Figure 3- 8

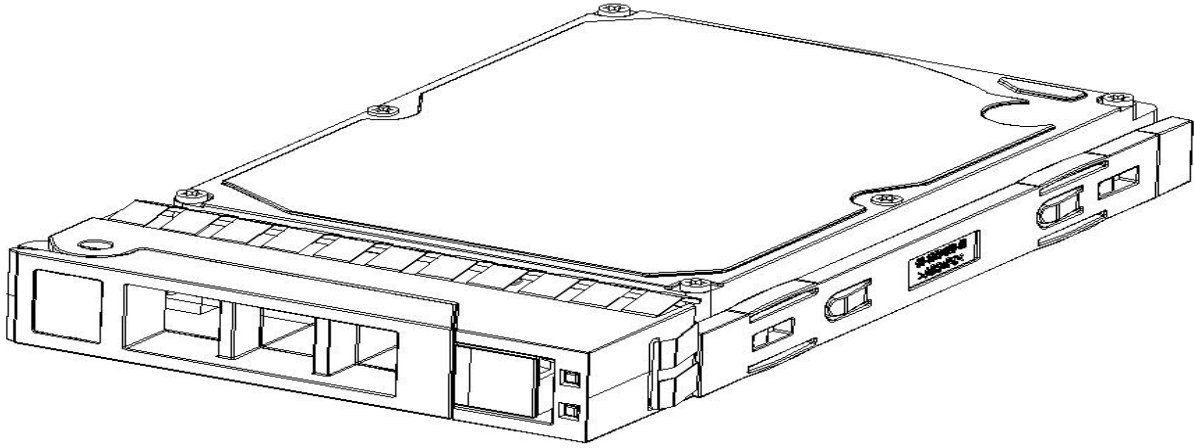

Figure 3- 9

HDD Tray Assembly Installed into Chassis

1. With the hard drive wrench open, push it into the chassis
2. When the hard disk gold finger touches the backplane device, turn the wrench in the direction of the arrow
3. Schematic diagram of hard disk installation in place

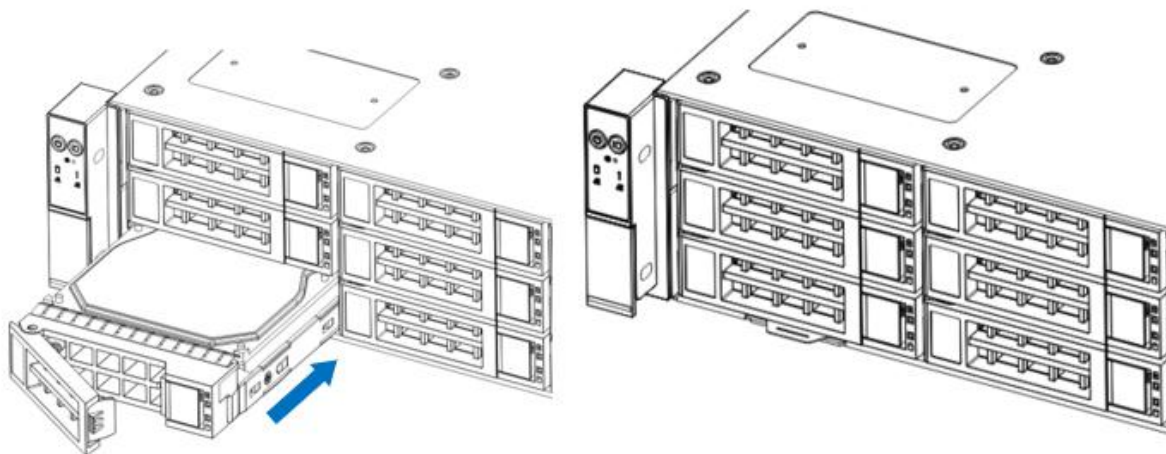

Figure 3- 10

3.5 Front hard disk backplane installation

Front hard disk backplane installation:

1. The gourd holes and hanging holes on the left and right sides of the disk backplane are aligned with the pegs of the hard disk frame, and advance in the direction of the arrow.
2. After the hard disk backplane is pushed into place, press the backplane down until all the hoist nails and hanging holes on both sides are in place.
3. Flip the fixing parts on the left and right sides of the hard disk backplane, and lay the fixing parts flat.

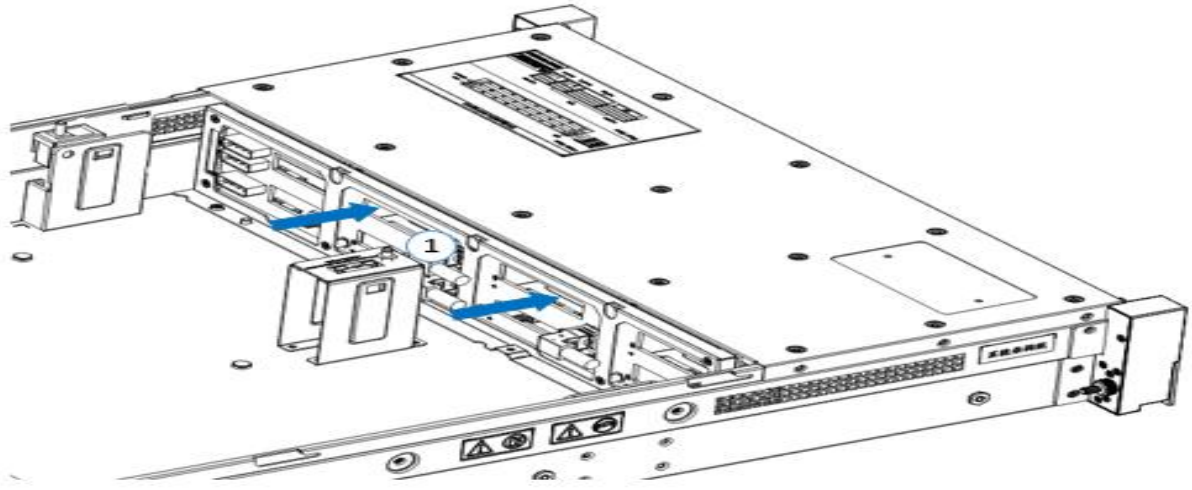

Figure 3- 11

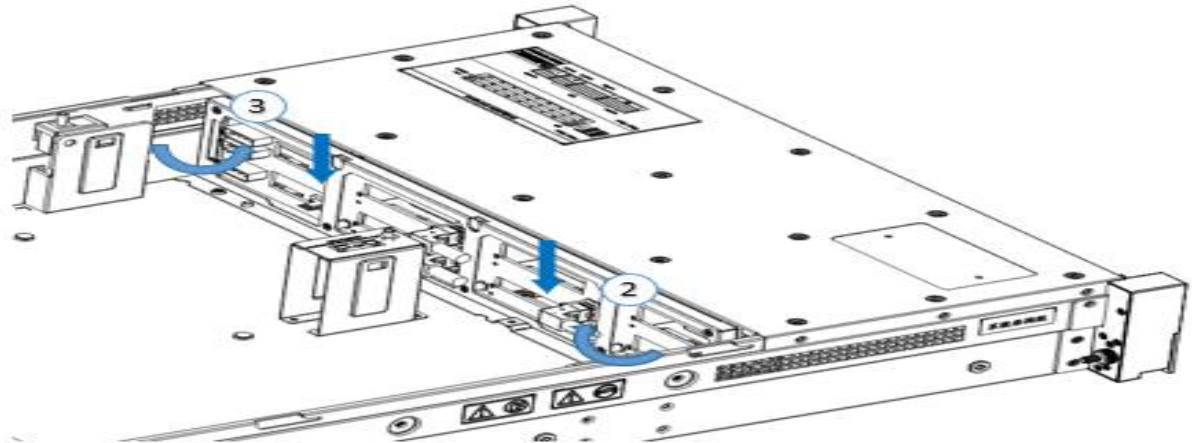

Figure 3- 12

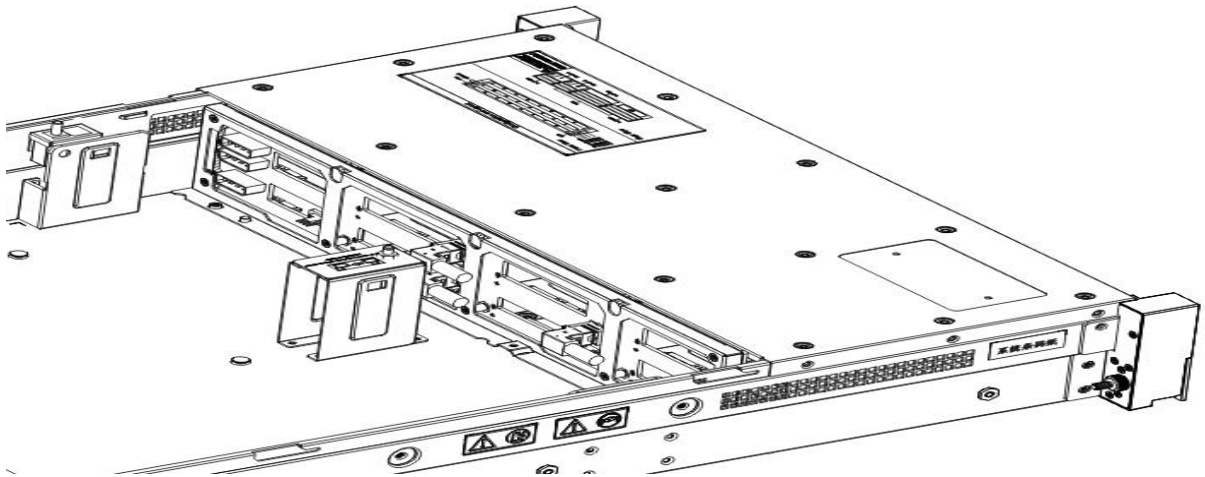

Figure 3- 13

3.6 M.2 SSD Installation

Step 1: Install the positioning studs according to the length of the M.2 card to be installed.

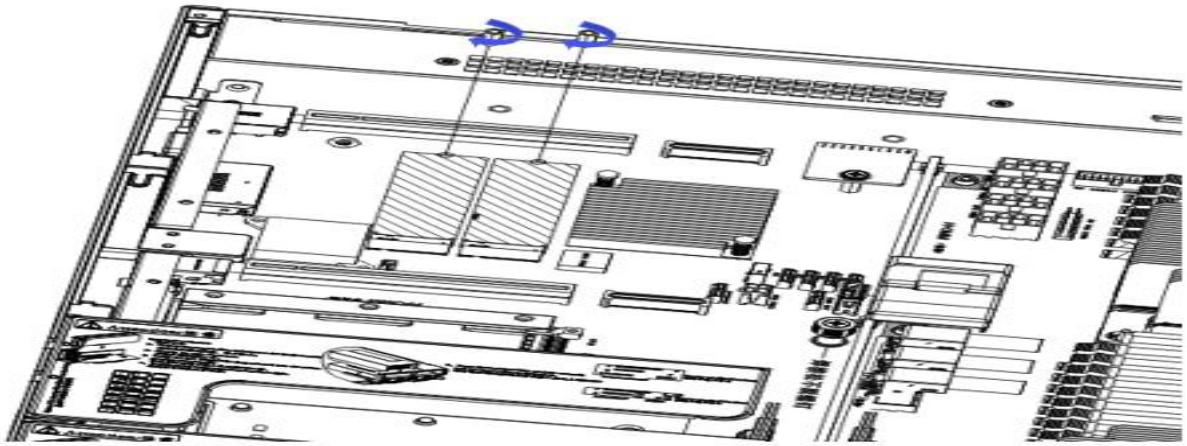

Figure 3- 14

Step 2: Install the M.2 Card

1. Insert the M.2 card connector end into the motherboard connector as shown in the illustration.
2. Press the other end of the M.2 card to the plane of the positioning stud in step 1.

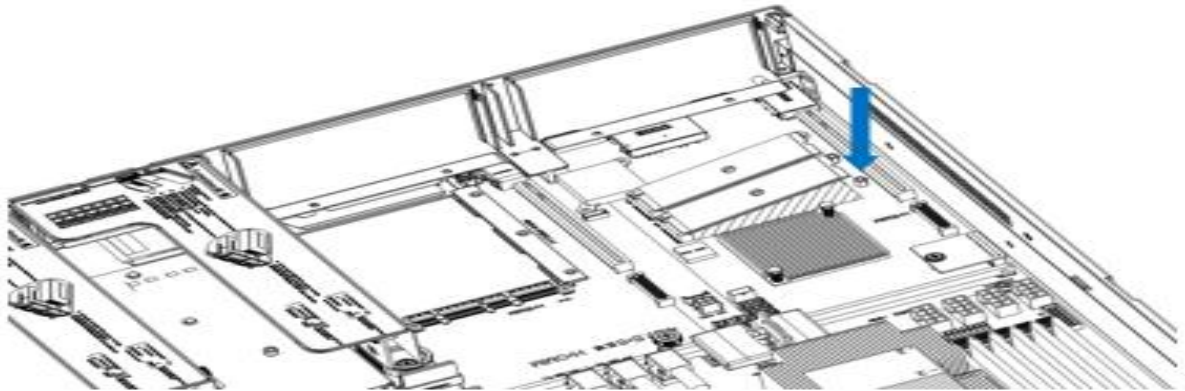

Figure 3- 15

Step 3: Install the fixing screws of the M.2 card.

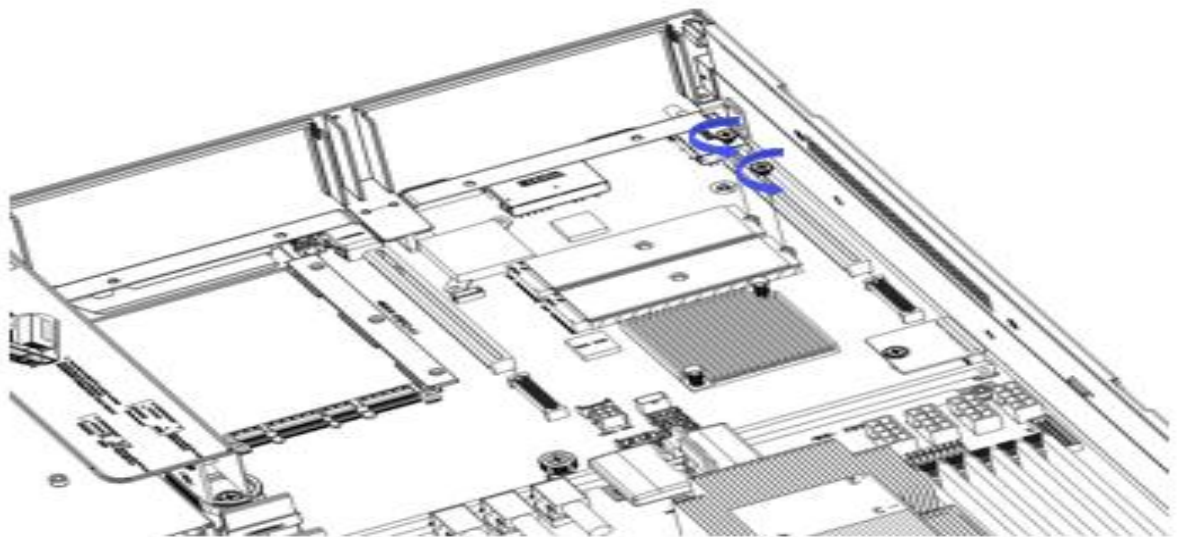

Figure 3- 16

3.7 Installation of PCI-E expansion card

Step: Install the PCIE Card

1. Insert the PCIE card according to the direction shown in the figure
2. Rotate PCIE card lock

3. According to the arrow plan, lock the PCIE card lock

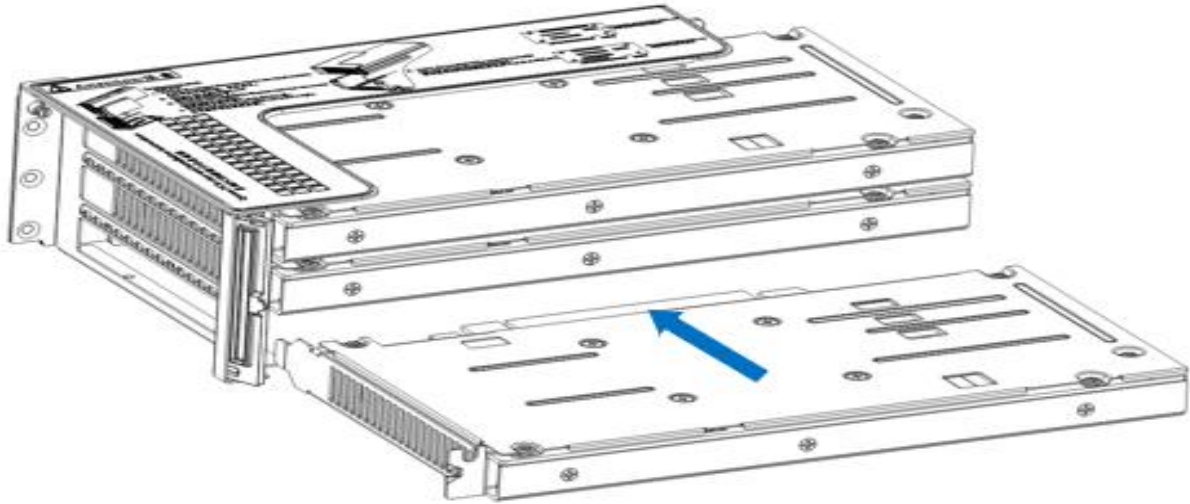

Figure 3- 19

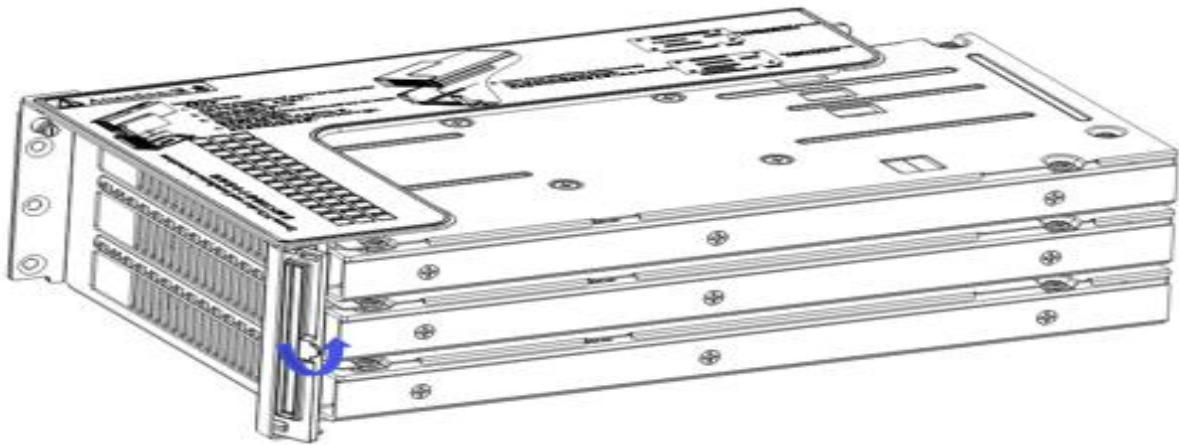

Figure 3- 20

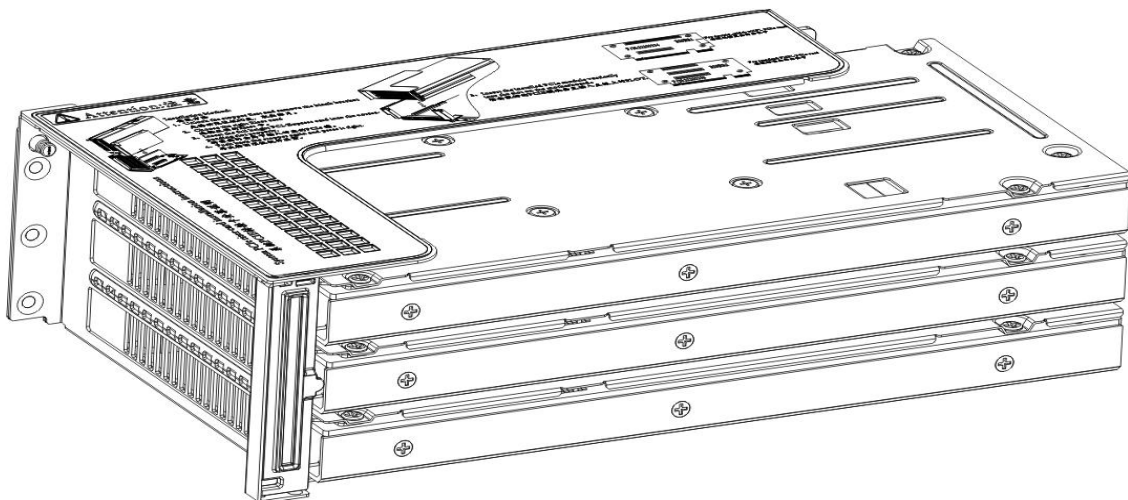

Figure 3- 21

3.8 PCI-E module installation

Riser1-3 module installation steps: PCI-E components on the rear window, place them vertically downward - align with the PCI-E slot, align with the positioning holes, and place them flush with the rear window.

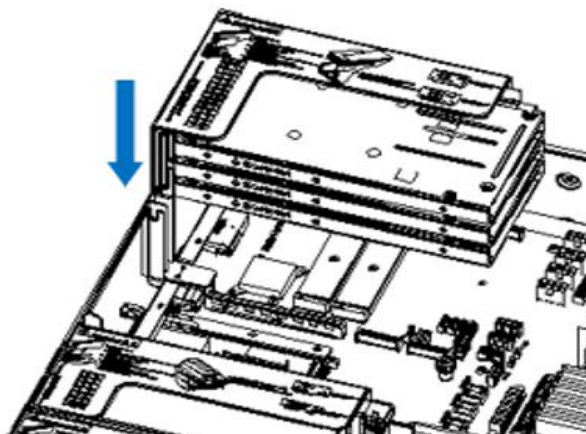

Figure 3.22

Riser4 module installation steps: PCIE components in the rear window, place vertically downwards - align the PCIE slot, align the positioning holes, place it flush with the rear window, and then tighten the side screws.

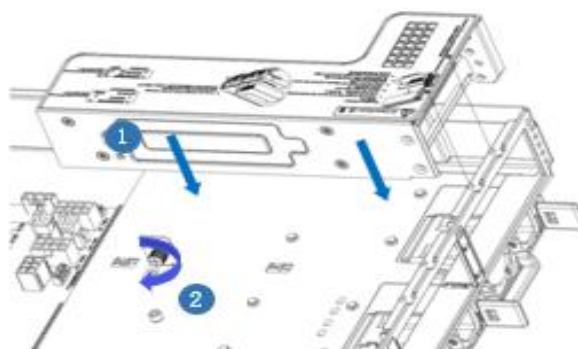

Figure 3. 23

3.9 Rear hard disk module backplane installation

Step 1: Rear hard disk Module Backplane Installation

1. Move the back plate limit shrapnel outwards with your hands, and hold the shrapnel with your hands - keep the shrapnel open

2. Align the peg holes on the backplane of the hard disk with the pegs of the hard disk module bracket, push it in, and place it down in place, release the hard disk limit shrapnel, and the shrapnel will automatically bounce back to the original position;

3. Flip over the fixing parts on the back panel of the hard disk, as shown in the figure - the fixing parts can be placed flat.

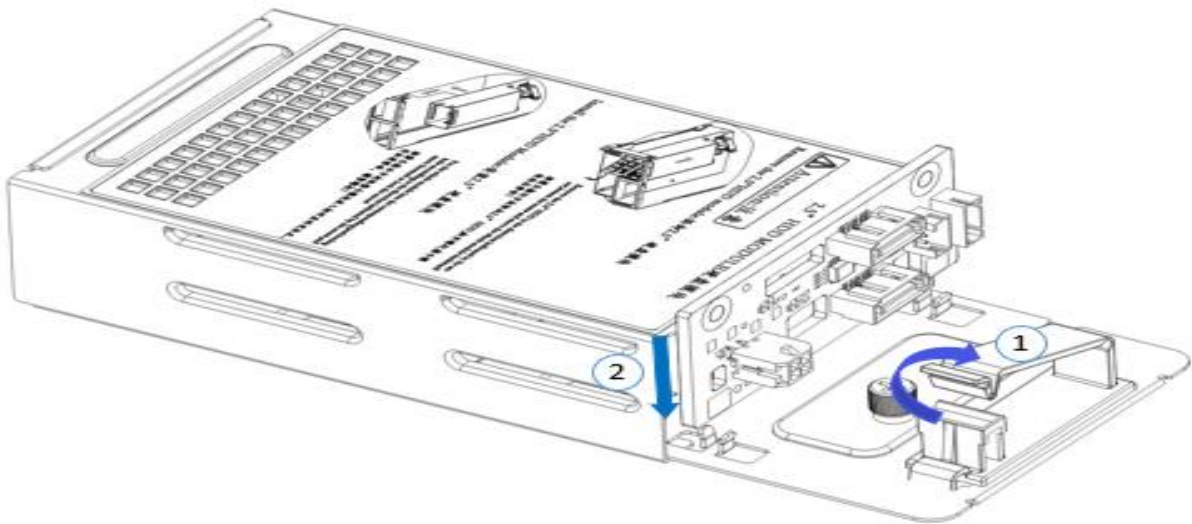

Figure 3- 24

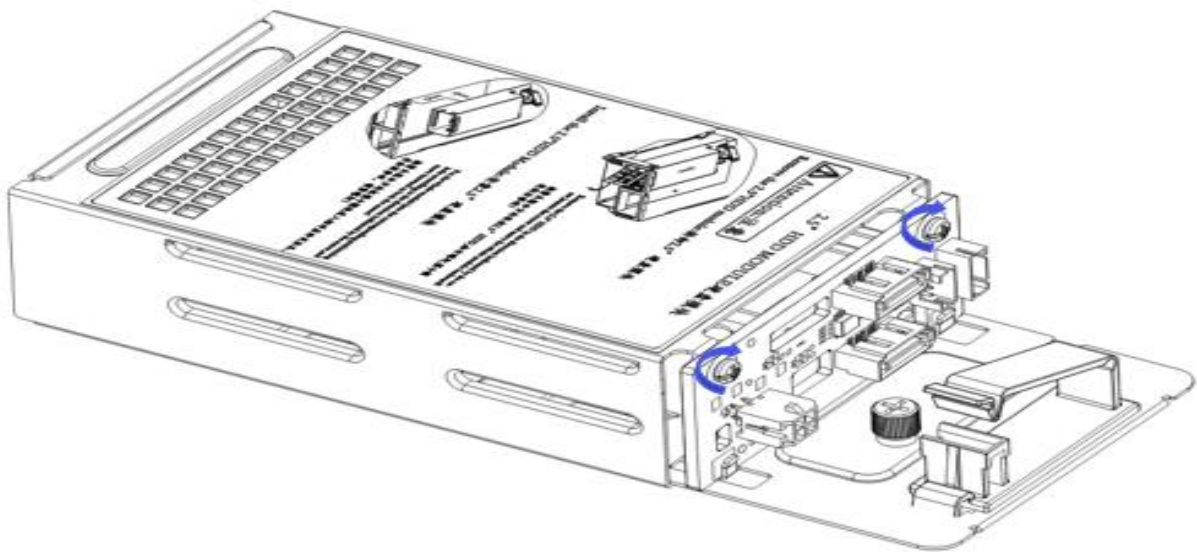

Figure 3- 25

3.10 Rear hard disk module installation

Rear 3.5-inch hard disk enclosure installation

Step 1. The hard disk box is placed vertically down and flush with the rear window

Step 2. Rear hard disk Cage Assembly Fixing

Step 3. Lock a captive screw

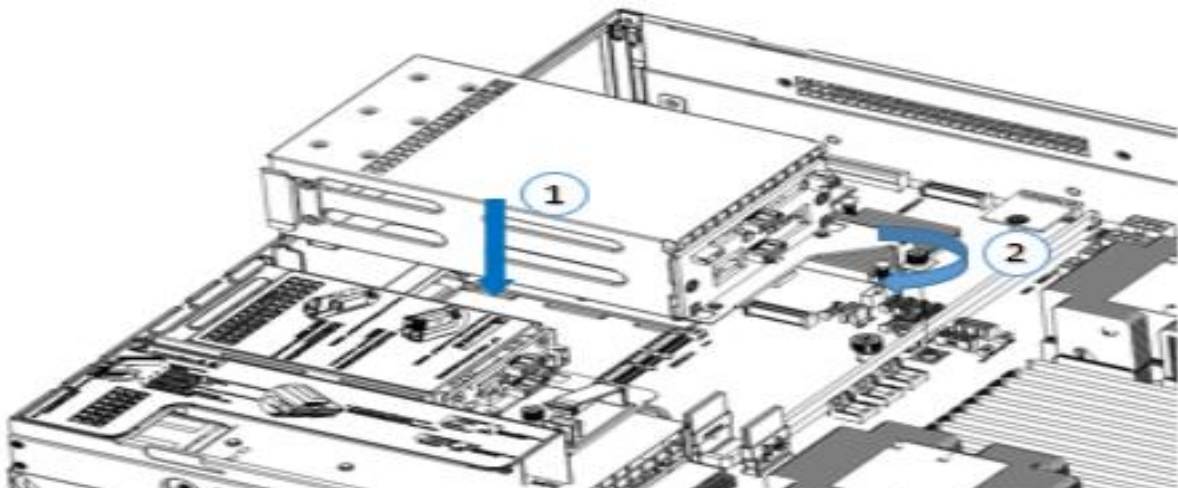

Figure 3- 26

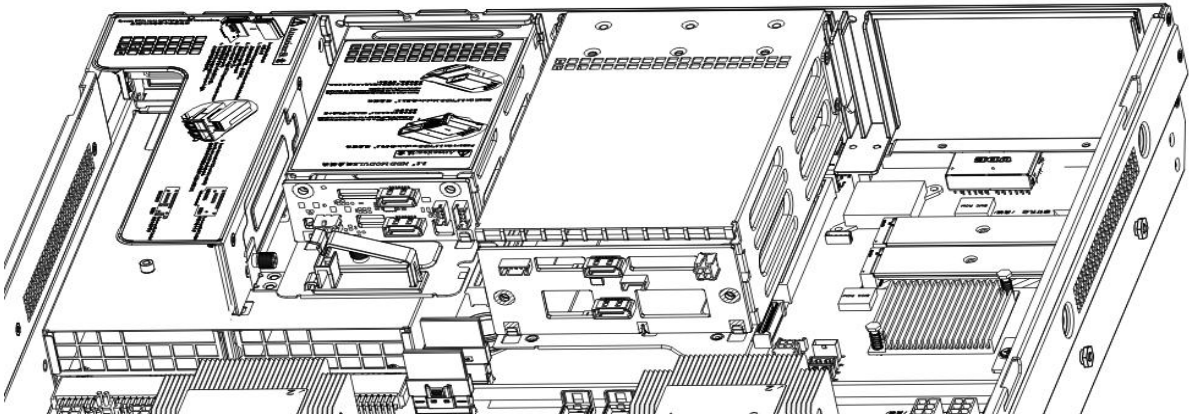

Figure 3- 27

Rear 2.5-inch hard disk enclosure installation

1. Place vertically downward and align with the guide pin at the lower end
2. After placing it flat, push it in the direction of the arrow to the end.
3. Lock the captive screw

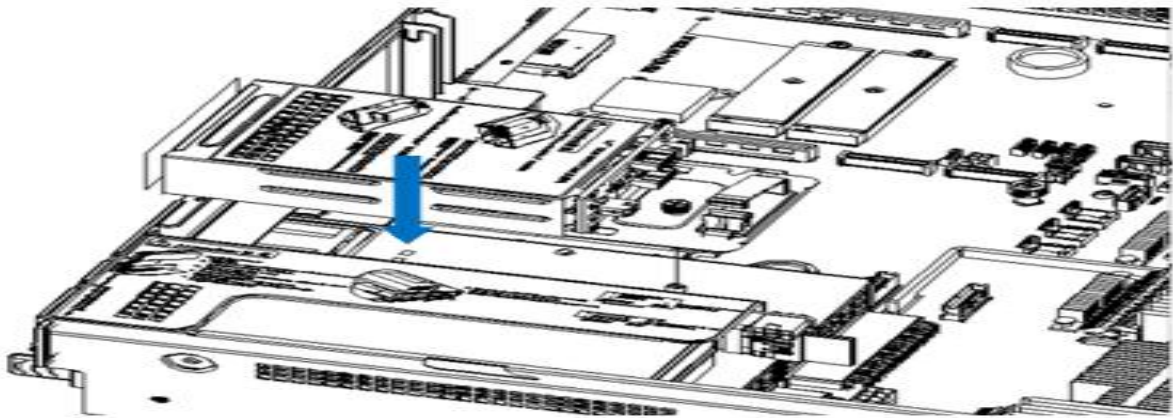

Figure 3- 28

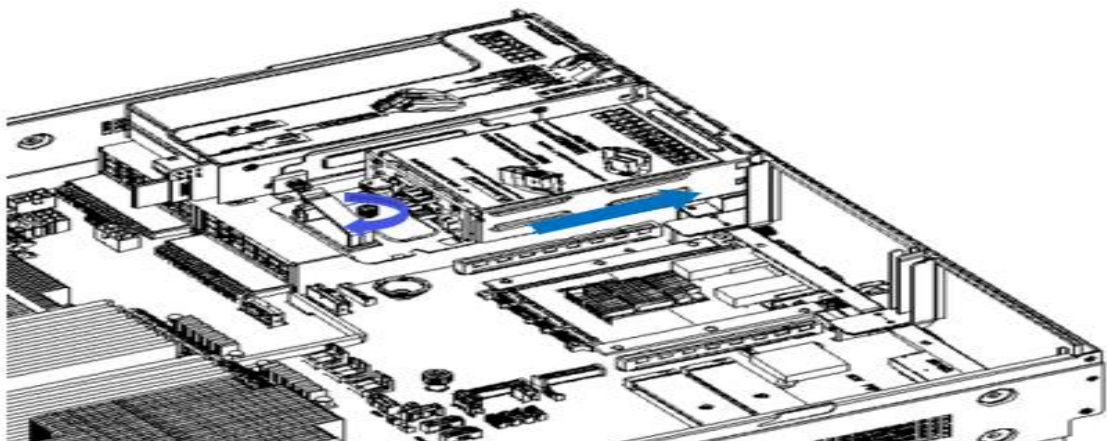

Figure 3- 29

3.11 Installation of Power Module

Steps: Push the power supply to the end in the direction of the arrow, and after the shrapnel wrench on the right makes a clicking sound, it means the installation is in place;

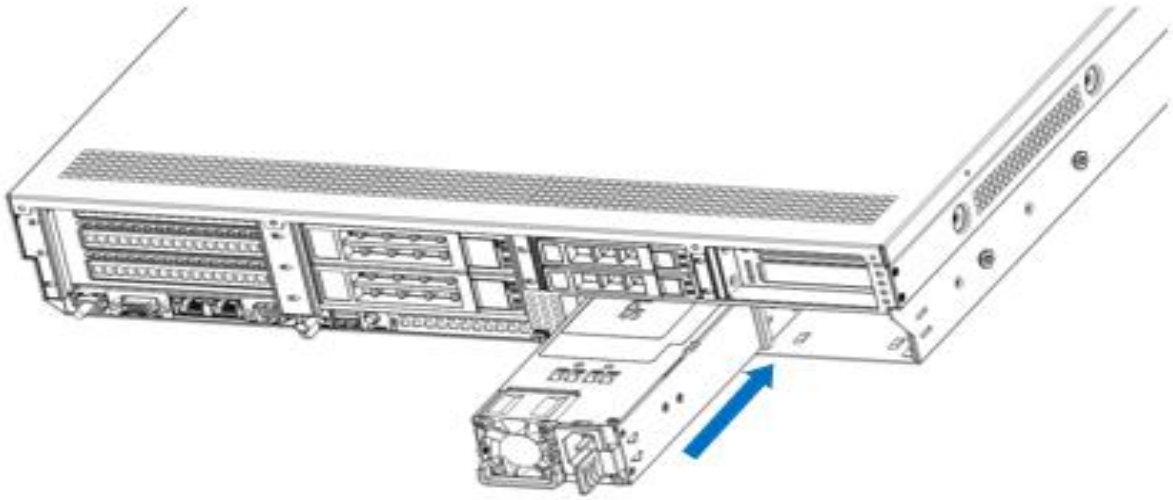

Figure 3- 30

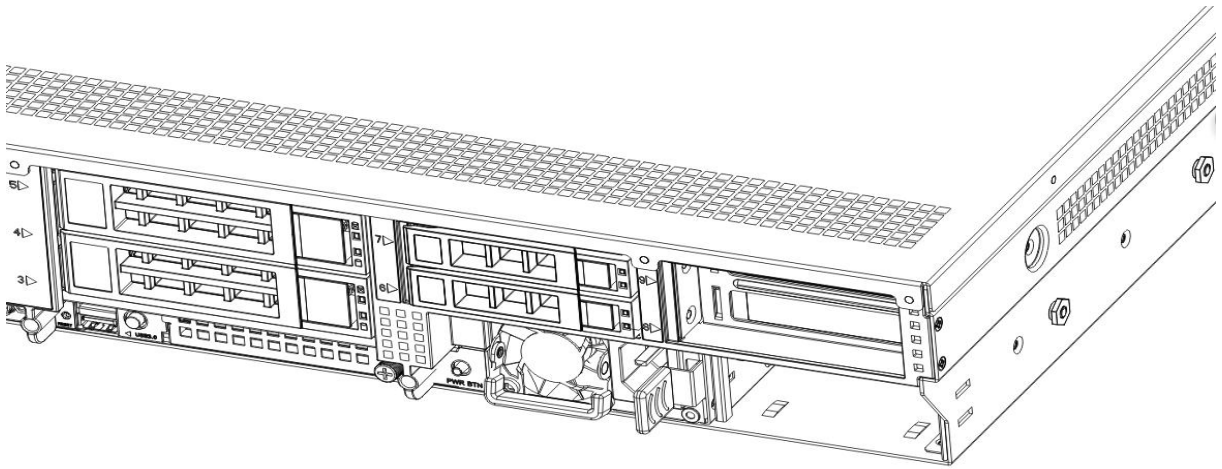

Figure 3- 31

3.12 Installation of the fan module

Steps: Place the fan module vertically downward in the direction of the arrow (pay attention to the direction of the fan module)

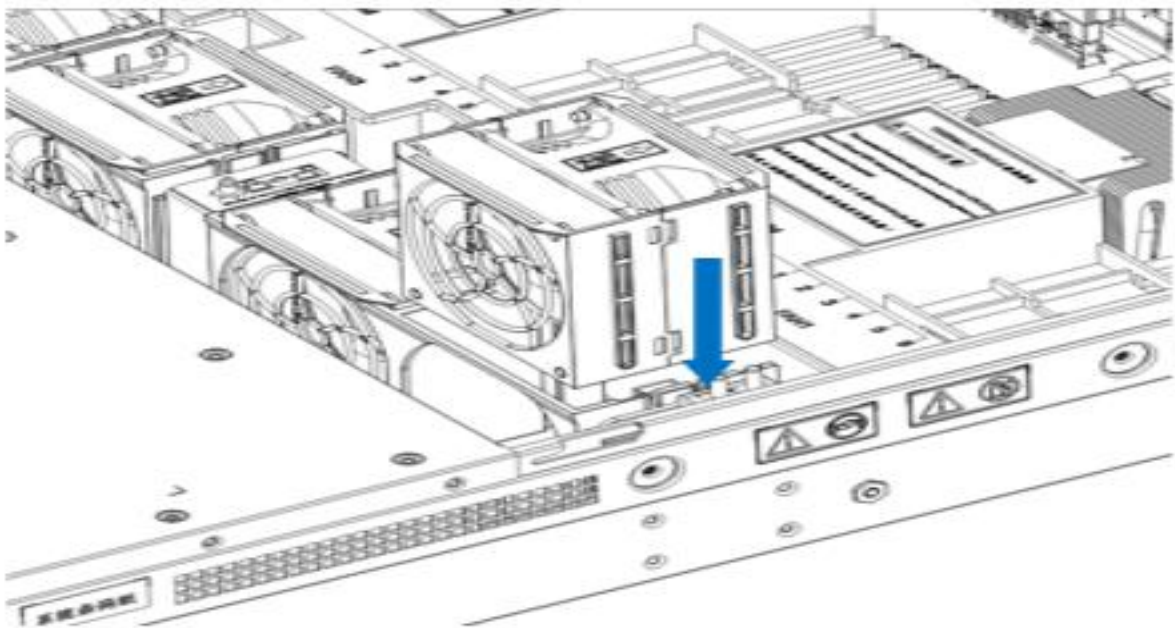

Figure 3- 32

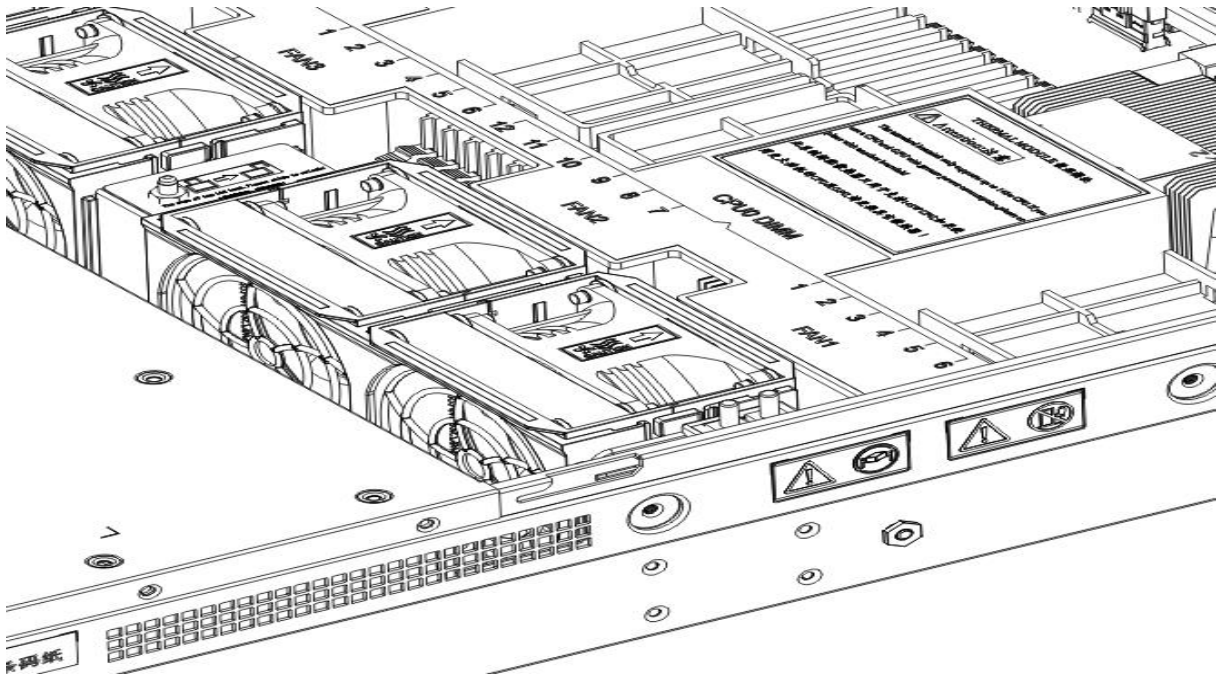

Figure 3- 33

3.13 Installation of the wind shield

Steps: Align the air deflector module with the hanging points on the left and right sides, and place it vertically downward - the height is lower than the height of the cabinet

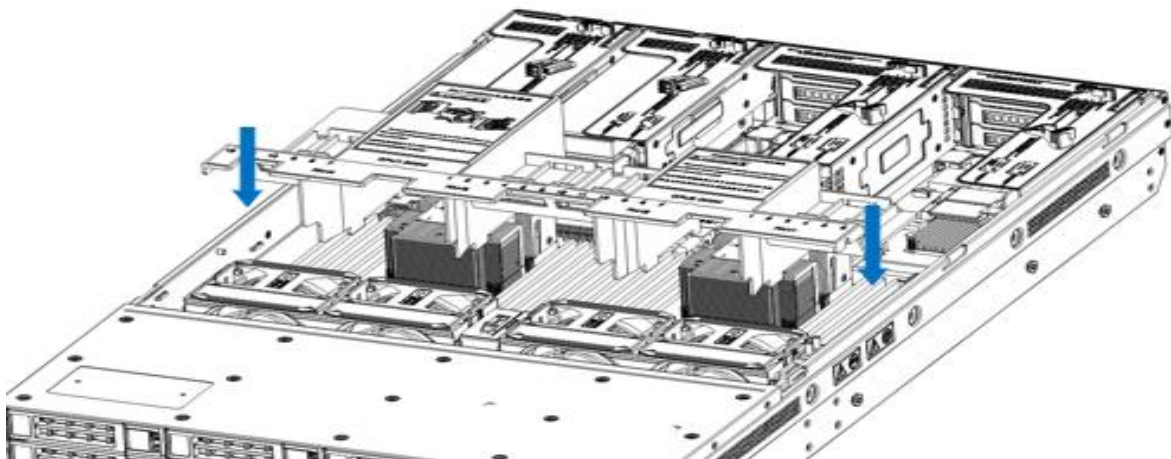

Figure 3- 34

3.14 Installation of CD/DVD-ROM

Steps: Install the CD/DVD-ROM

1. The optical drive is as shown in Figure 3-35:

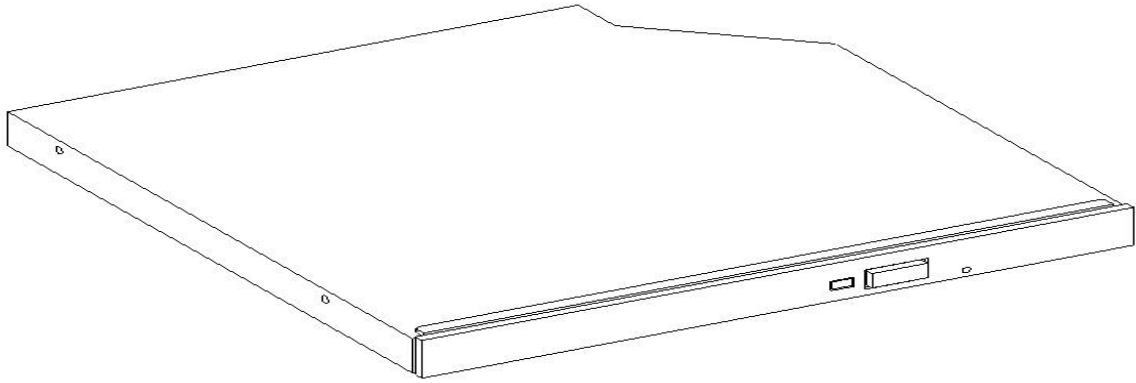

Figure 3- 35

2. Align the opening of the optical drive on the chassis, and push the optical drive in the direction of the arrow until the fixing part locks automatically.

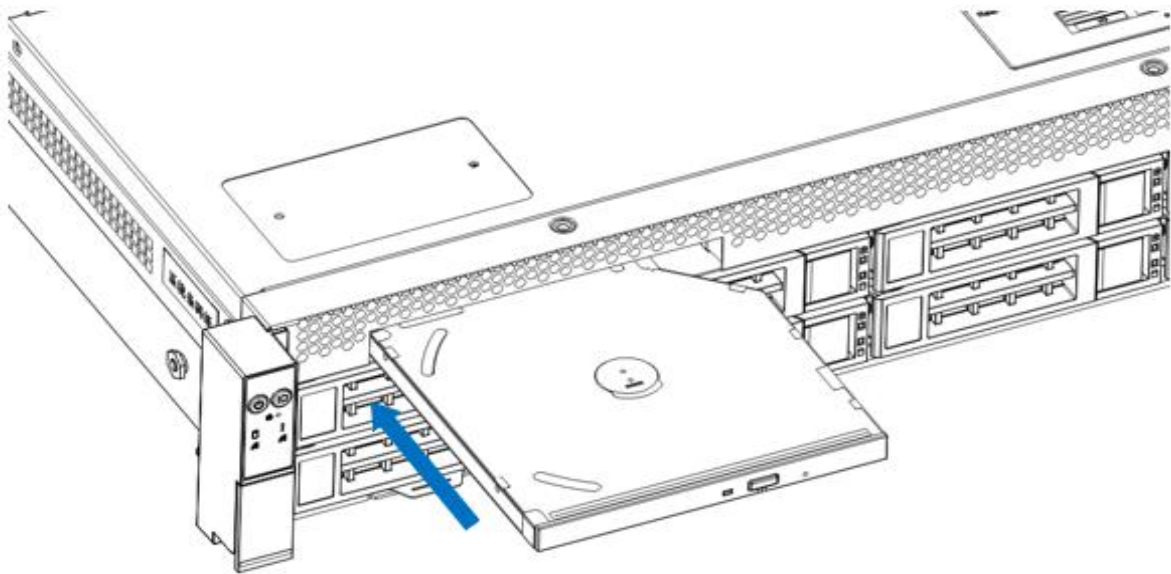

Figure 3- 36

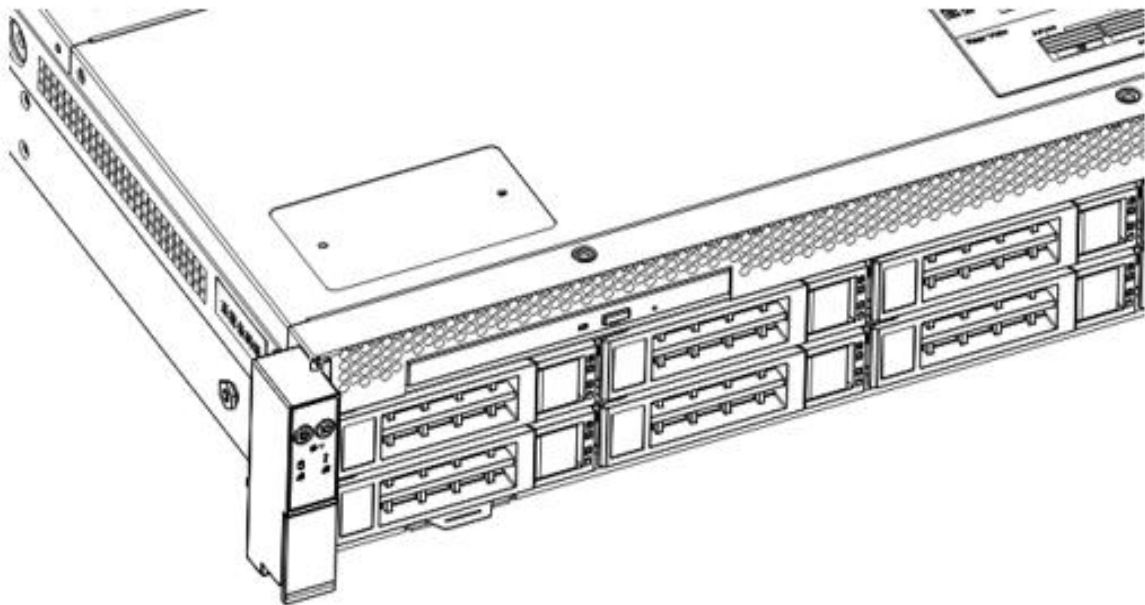

Figure 3- 37

3.15 Installation of the upper cover of the chassis

Step 1: Install the case back cover

1. Align the top cover with the opening of the box and place it downwards
2. Rotate the upper cover lock in the direction of the arrow to lock it in place

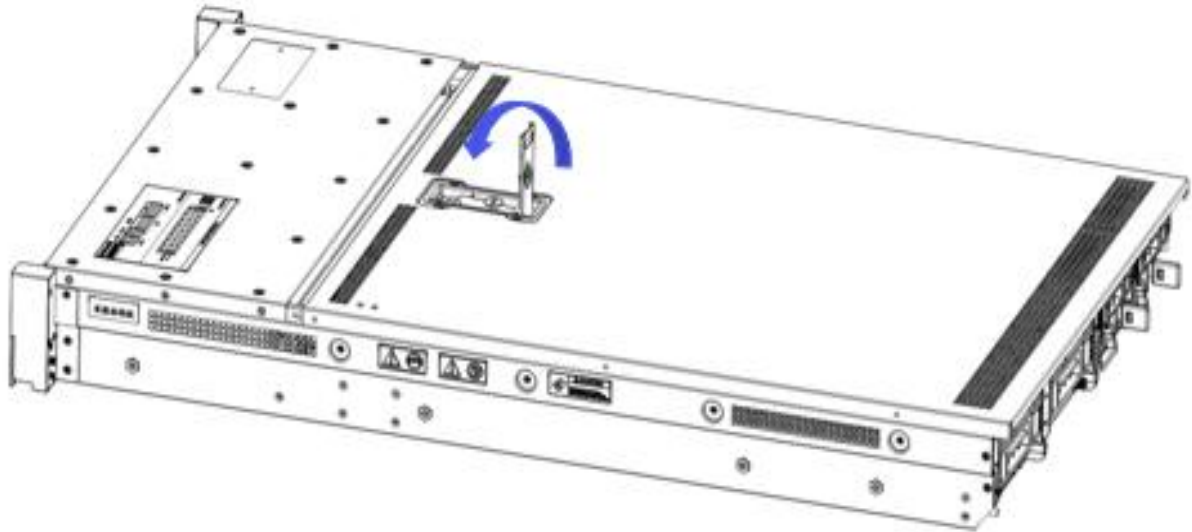

Figure 3- 38

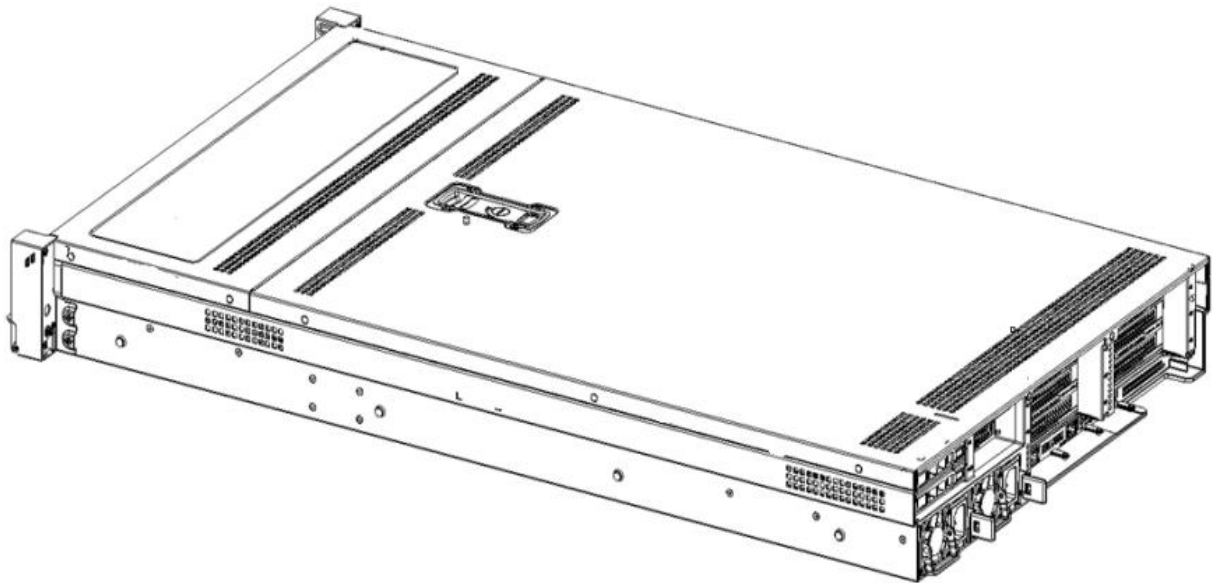

Figure 3- 39

Chapter 4 System Rack Installation

4.1 Mounting on the inner rail of the guide rail

Step 1. Prepare two slide rails and pull out the inner rail.

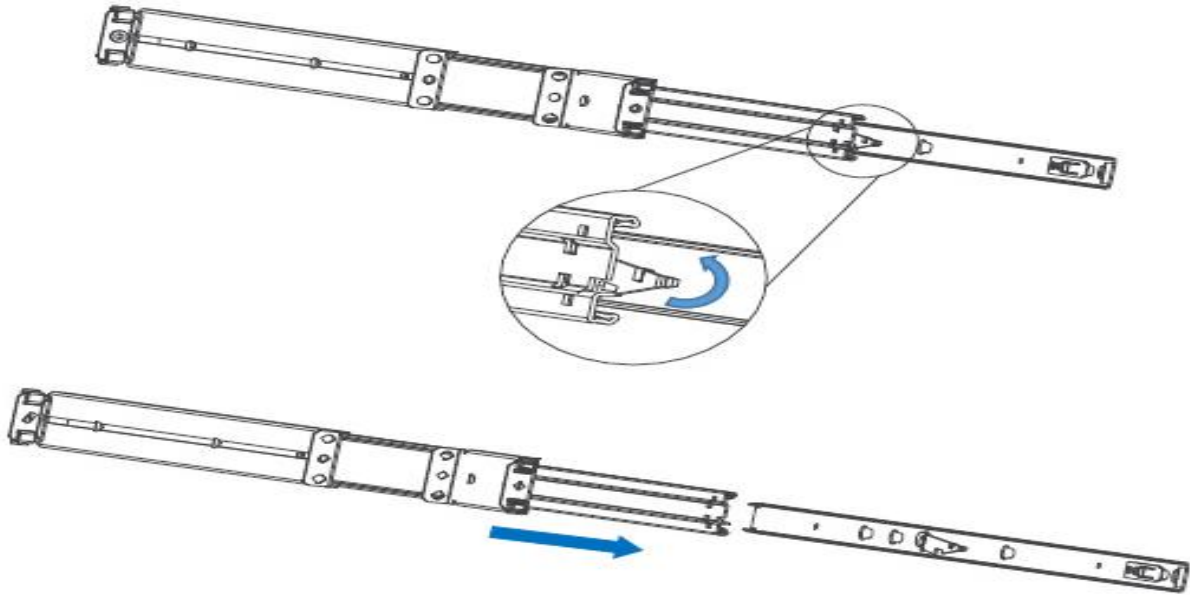

Figure 4- 1

Step 2. Fasten the inner rails on both sides of the chassis.

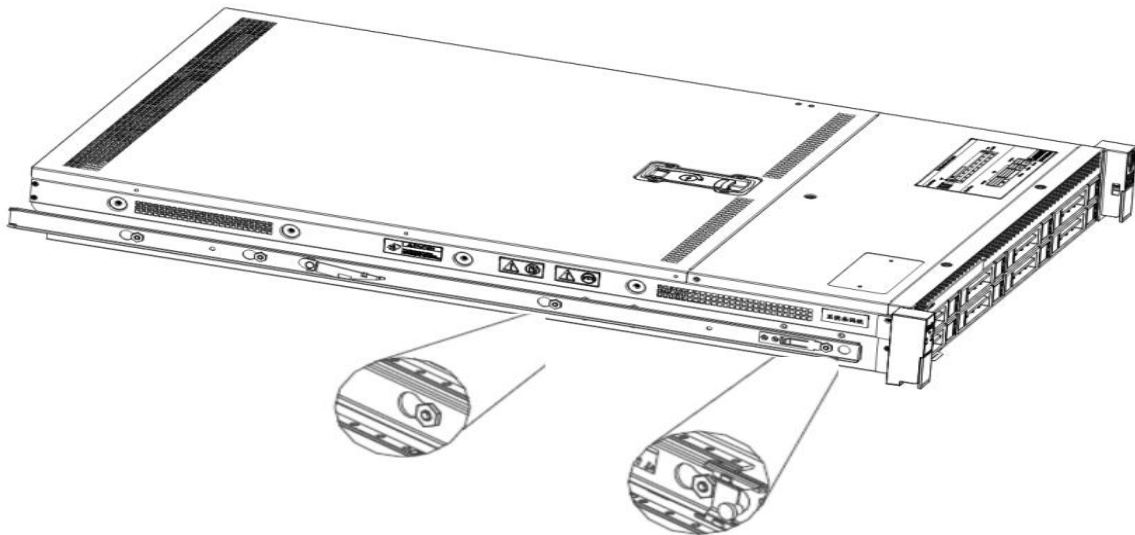

Figure 4- 2

4.2 Installing the outer rails to the rack

Step 3. Install the outer rail on the cabinet bracket and tighten the screws.

Note: When installing the rail, you need to align the U mark, and install it in place when you hear a snap, and use M5 screws to tighten it.

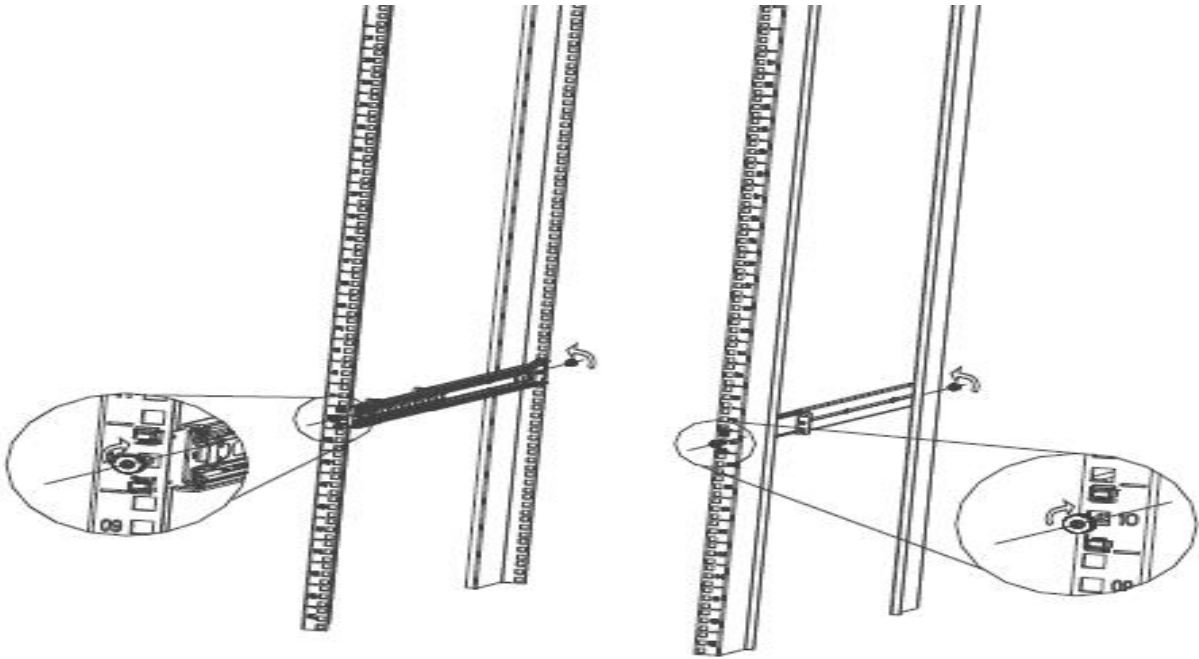

Figure 4- 3

4.3 Install the server to the rack

Step 4. Align the chassis with the inner rails installed on the outer rails for installation.

Note: When you can push the chassis forward, you will hear a popping sound. If you can't push it, you need to pull the inner rail buckle down to continue to push the chassis gently.

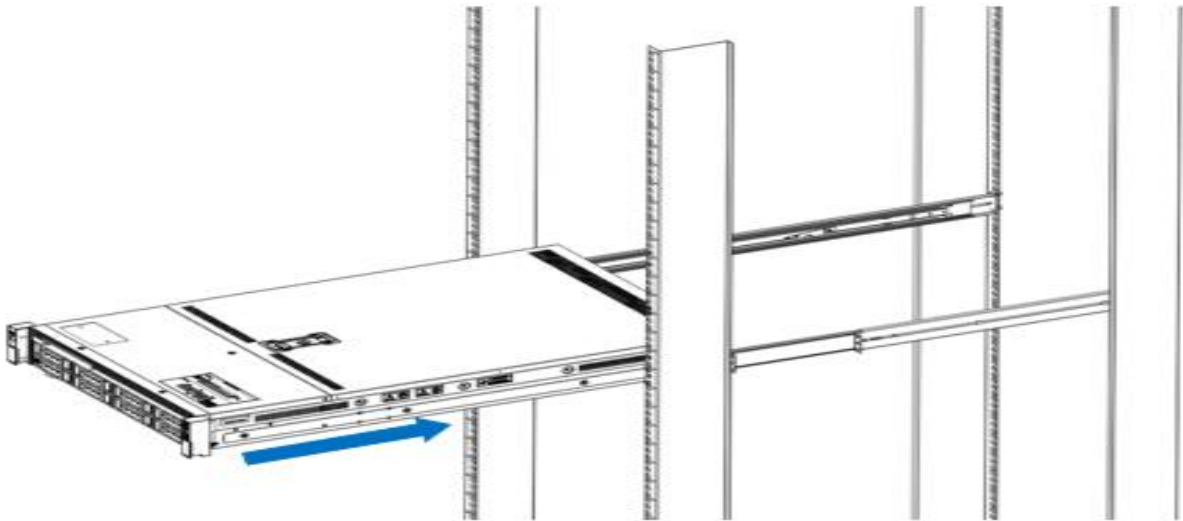

Figure 4- 4

Step 5. When the chassis is pushed forward and cannot slide, the screw installation is completed.

Note: During equipment maintenance, you need to loosen the panel screws, pull the chassis lightly, and do not push or pull the chassis at random to avoid damage to the equipment.

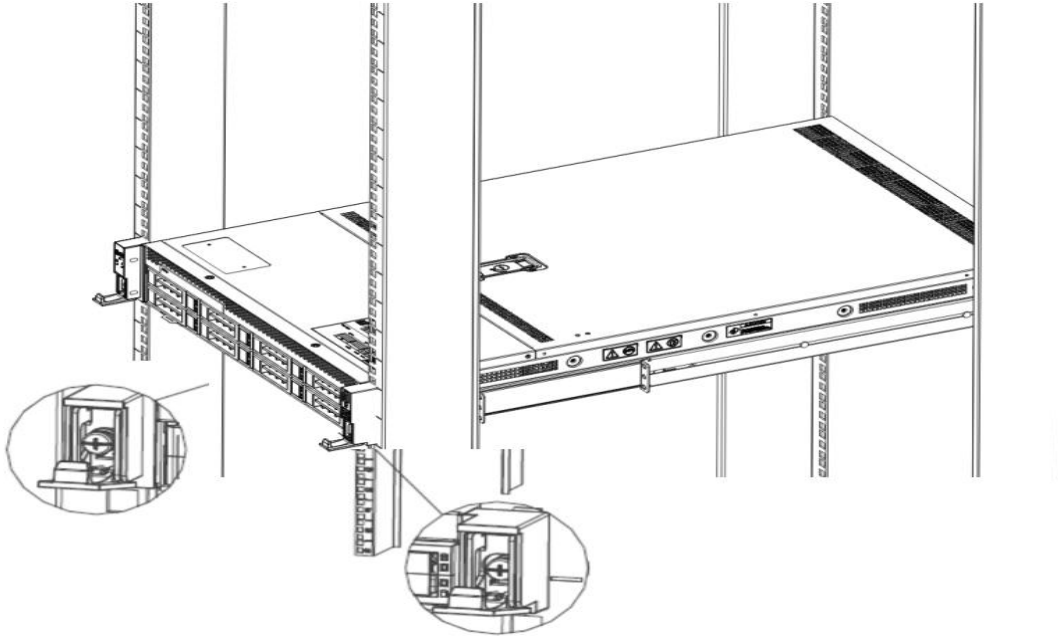

Figure 4- 5

Chapter 5 BIOS parameter settings

5.1 Enter the BIOS Setup interface

Steps:

1. Power on the server motherboard and connect the keyboard;
2. During the POST process, pay attention to the prompt to enter the BIOS Setup interface at the bottom left of the Logo screen, "Press or <ESC> to enter setup, <F7> to enter Boot Menu.";
3. Press the or <ESC> key on the keyboard to prepare to enter the BIOS Setup interface;

5.2 Setup menu parameter description

5.2.1 Navigation Key Description

→←:	Select Screen
↑↓:	Select Item
Enter:	Select
+/-:	Change Opt.
F1:	General Help
F2:	Previous Values
F3:	Optimized Defaults
F4:	Save & Reset
ESC:	Exit

5.2.2 Main menu description

The Main interface contains the basic information of the BIOS system, such as BIOS version number, CPU model, memory capacity, and system time can be set.

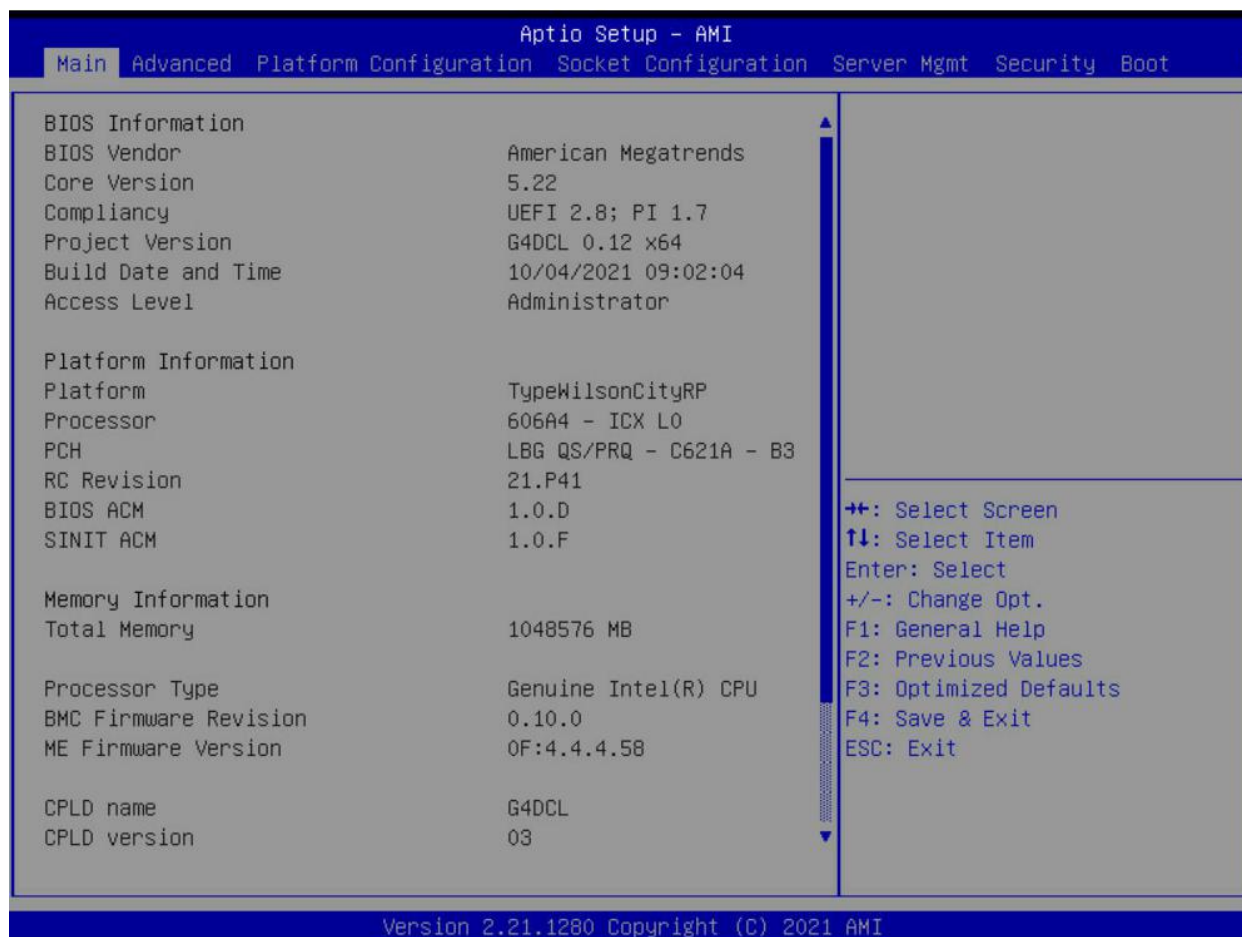

Figure 5- 1

BIOS Information**Project Version:**

Displays the version information of the board BIOS.

Build Date and Time:

Displays the compilation date and time of the board BIOS.

BMC Firmware Revision:

Displays the version information of the board BMC.

ME Firmware Version:

Displays the version information of the board ME.

CPLD Name:

Displays the name information of the board CPLD.

CPLD Version:

Displays the version information of the board CPLD.

Build Date and Time:

Displays the compilation date and time of the board CPLD.

Access Level:

Displays the access rights of the current user of the board.

Platform Information**Processor:**

CPUID and stepping information.

Processor Type:

CPU model information.

PCH:

PCH SKU and stepping information.

RC Revision:

Displays the version information of the board RC.

Memory information

Total Memory:

Displays the total system memory capacity.

Usable Memory:

Displays the amount of available memory in the system.

System Language:

Select the current system language.

System Date:

Displays and sets the current system date. The format of the system date is "week month/day/year". Press "Enter" to switch between month, day, and year. You can change the value in the following ways:

Press "+": the value increases by 1.

Press "-": the value decreases by 1.

Press the number key: directly change the value.

System Time:

Display and set the current system time. The system time is in 24-hour format, and the format is "hour:minute:second". Press "Enter" to switch between hours, minutes, and seconds. You can change the value in the following ways:

Press "+": the value increases by 1.

Press "-": the value decreases by 1.

Press the number key: directly change the value.

5.2.3 Advanced menu description

The Advanced interface contains advanced configuration items of the BIOS system.

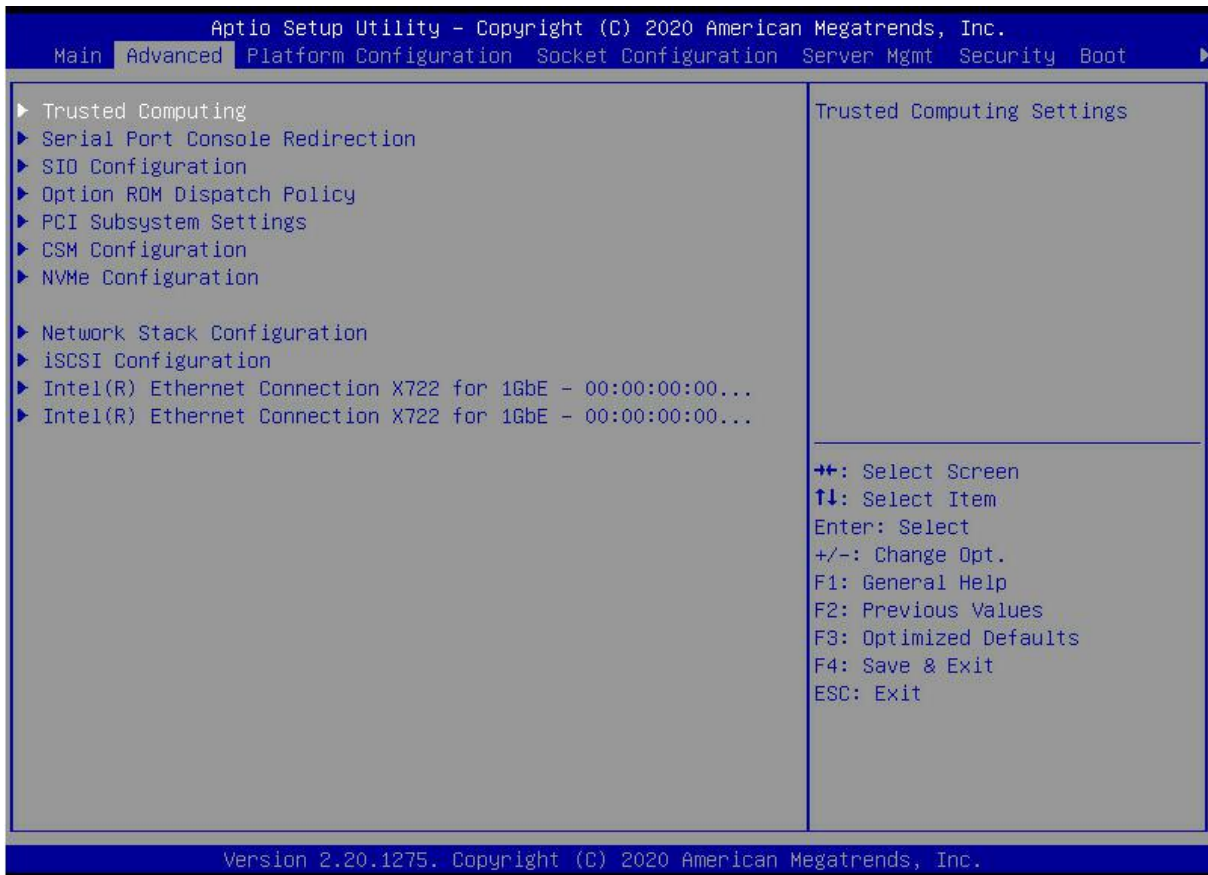

Figure 5- 2

Trusted Computing

Trusted Execution Module configuration.

Serial Port Console Redirection

Serial port redirection configuration.

SIO Configuration

Option ROM Dispatch Policy

PCI Subsystem Settings

CSM Configuration

NVMe Configuration

Network Stack Configuration

iSCSI Configuration

Intel Ethernet Connection X722 for xGbE - XX:XX:XX:XX:XX:XX

Intel xG network card UEFI OPROM configuration

5.2.4 Trusted Computing



Figure 5- 3

Display and set TCM/TPM module information. Different module options have different settings. Users can set according to the Setup help instructions.

5.2.5 Serial Port Console Redirection

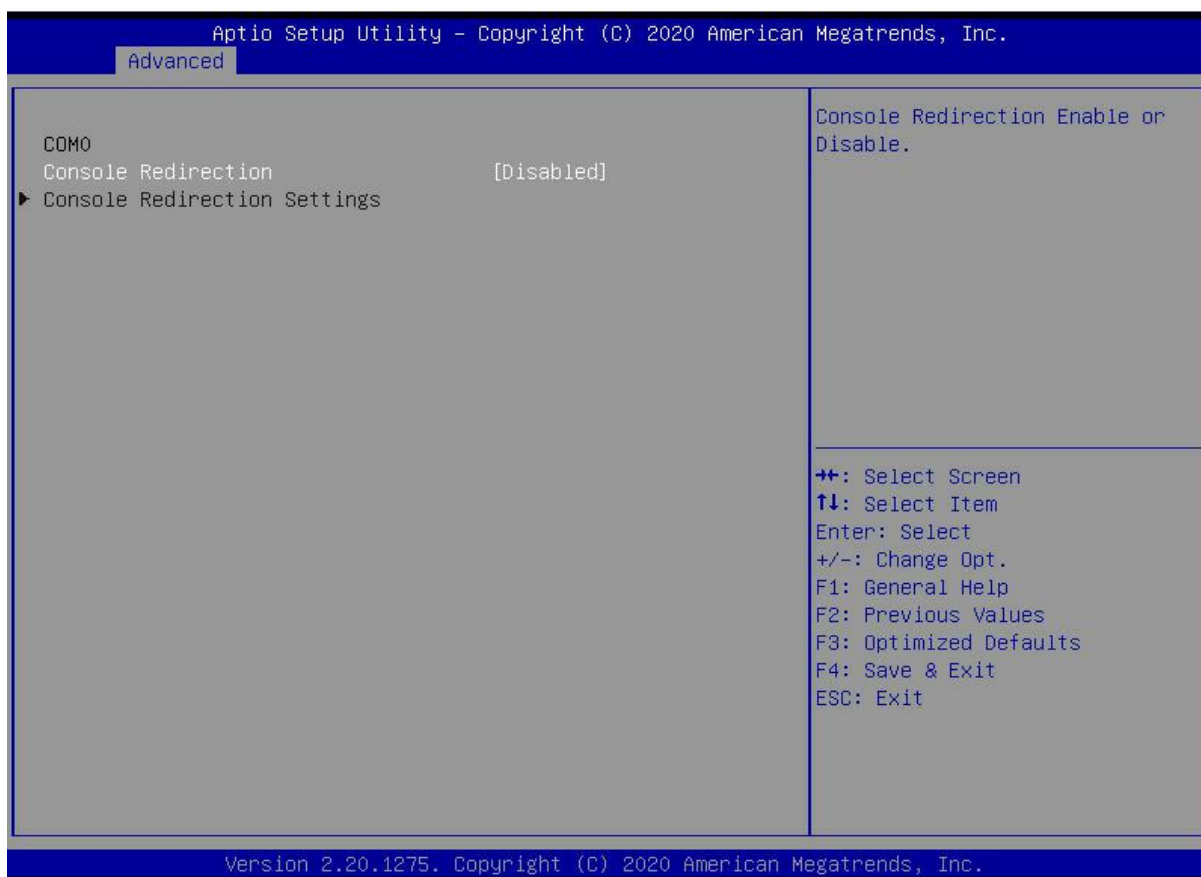

Figure 5- 4

Console Redirection

The console redirection function switch redirects the information output from the console (such as a graphics card) to the display to the serial port.

Disabled: Disable the redirection function.

Enabled redirection.

Default: Disabled

5.2.6 Console Redirection Settings

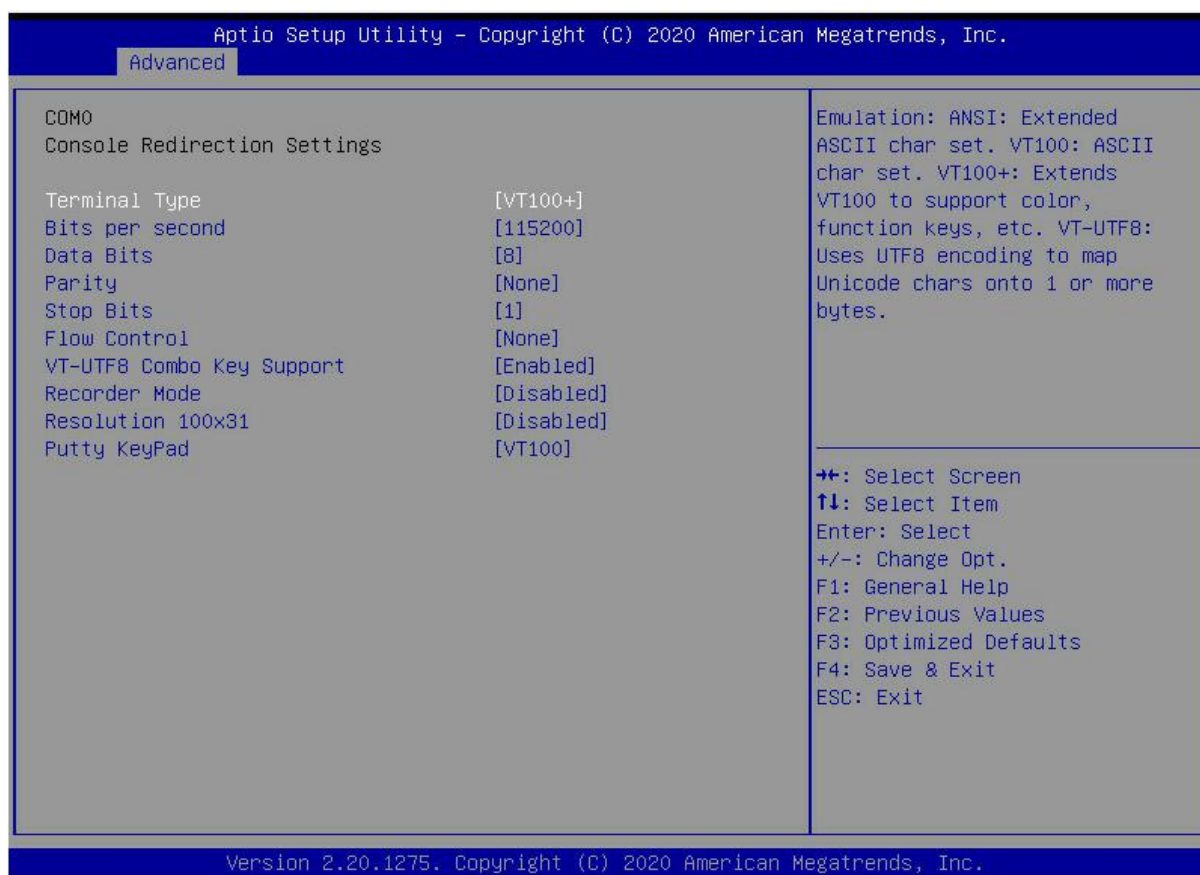

Figure 5- 5

Terminal Type

This option selects the emulation type, the BIOS emulation type must match the mode selected in the terminal program. The menu options are:

- VT100
- VT100+
- VT-UTF8
- ANSI
- Default: VT100+

Bits per second

Serial port redirection rate, the value range is 9600~115200
 Default: 115200

Data Bits

Serial port redirection data bit length, menu options are: 8, 7
 Default: 8

Parity

Serial port redirection verification switch, the menu options are:

- None: no verification
- Even: Even parity
- Odd: odd parity
- Mark: The check digit is always 1
- Space: The check digit is always 0
- Default: None

Mark and Space checks are not allowed to detect errors.

Stop Bits

Serial port data packet end flag, the menu options are:

1

2

Default: 1

Flow Control

Serial port redirection control flow selection switch, the menu options are:

None: close the serial port redirection control flow

Hardware RTS/CTS: Request to Send/Clear to Send

Default: None

VT-UTF8 Combo key support

ANSI/VT100 terminal VT-UTF8 key combination support switch, the menu options are:

Disabled: Disable ANSI/VT100 terminal VT-UTF8 key combination support

Enabled ANSI/VT100 terminal VT-UTF8 key combination support

Default: Enabled

Recorder Mode

Record mode switch, enable this function, only text information will be sent, the menu options are:

Enabled

Disabled

Default: Disabled

5.2.7 SIO Configuration

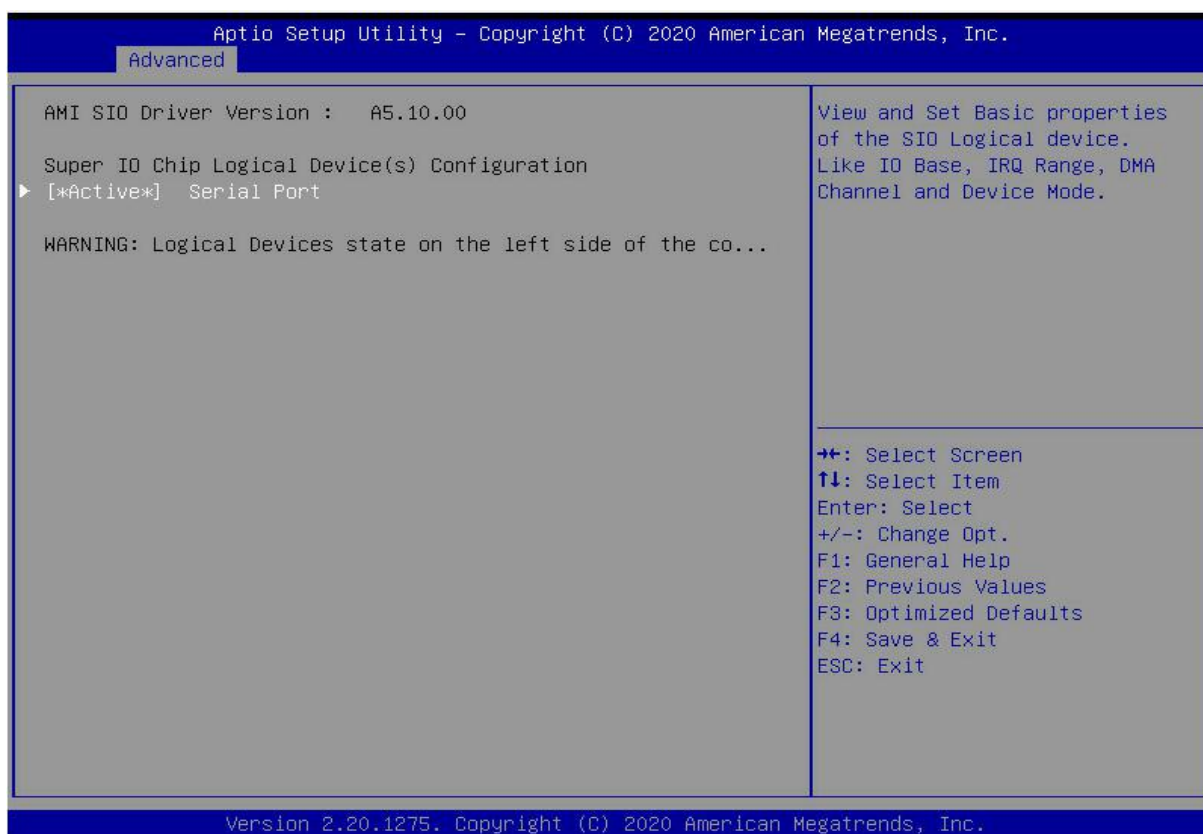

Figure 5- 6

5.2.8 [*Active*] Serial Port



Figure 5- 7

Use This Device

With this device, the menu options are:

Enabled

Disabled

Default: Enabled

Possible

Select the optimal setting for the serial port according to your needs. The menu options are:

Use Automatic Settings

IO=3F8h; IRQ=4; DMA;

IO=3F8h; IRQ=3,4,5,7,9,10,11,12; DMA;

IO=2F8h; IRQ=3,4,5,7,9,10,11,12; DMA;

IO=3E8h; IRQ=3,4,5,7,9,10,11,12;DMA;

IO=2E8h; IRQ=3,4,5,7,9,10,11,12; DMA;

Default: Use Automatic Settings

5.2.9 Option ROM Dispatch Policy

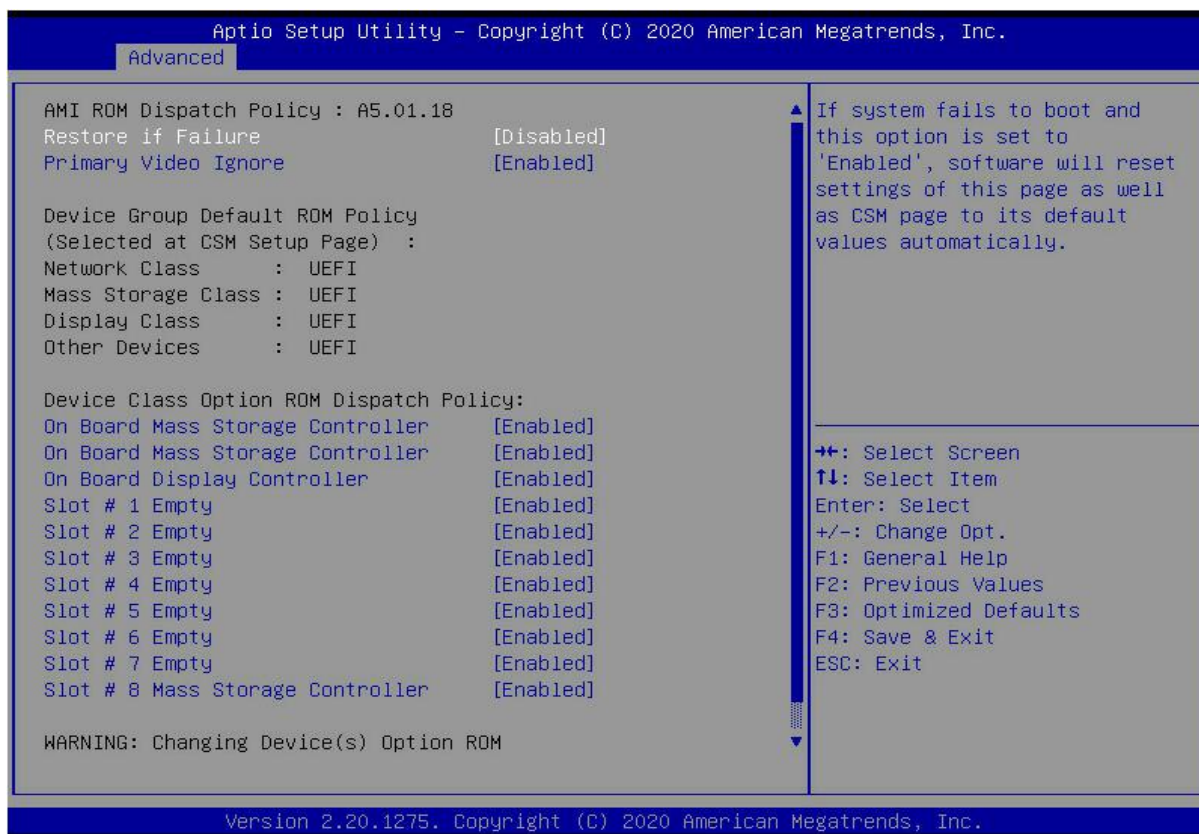

Figure 5-8

Manage Option ROM call policy

Restore if Failure

To recover from a failure, the menu options are:

Enabled

Disabled

Default: Disabled

Primary Video Ignore

Ignoring the base graphics card, the menu options are:

Enabled

Disabled

Default: Enabled

On Board Mass Storage Controller

Onboard or external device controller, the menu options are:

Enabled

Disabled

Default: Enabled

On Board Mass Storage Controller

Onboard or external device controller, the menu options are:

Enabled

Disabled

Default: Enabled

On Board Display Controller

Onboard or external device controller, the menu options are:

Enabled

Disabled

Default: Enabled

Slot # 1 Empty

Onboard or external device controller, the menu options are:

Enabled

Disabled

Default: Enabled

Slot # 8 Empty

Onboard or external device controller, the menu options are:

Enabled

Disabled

Default: Enabled

5.2.10 PCI Subsystem Settings

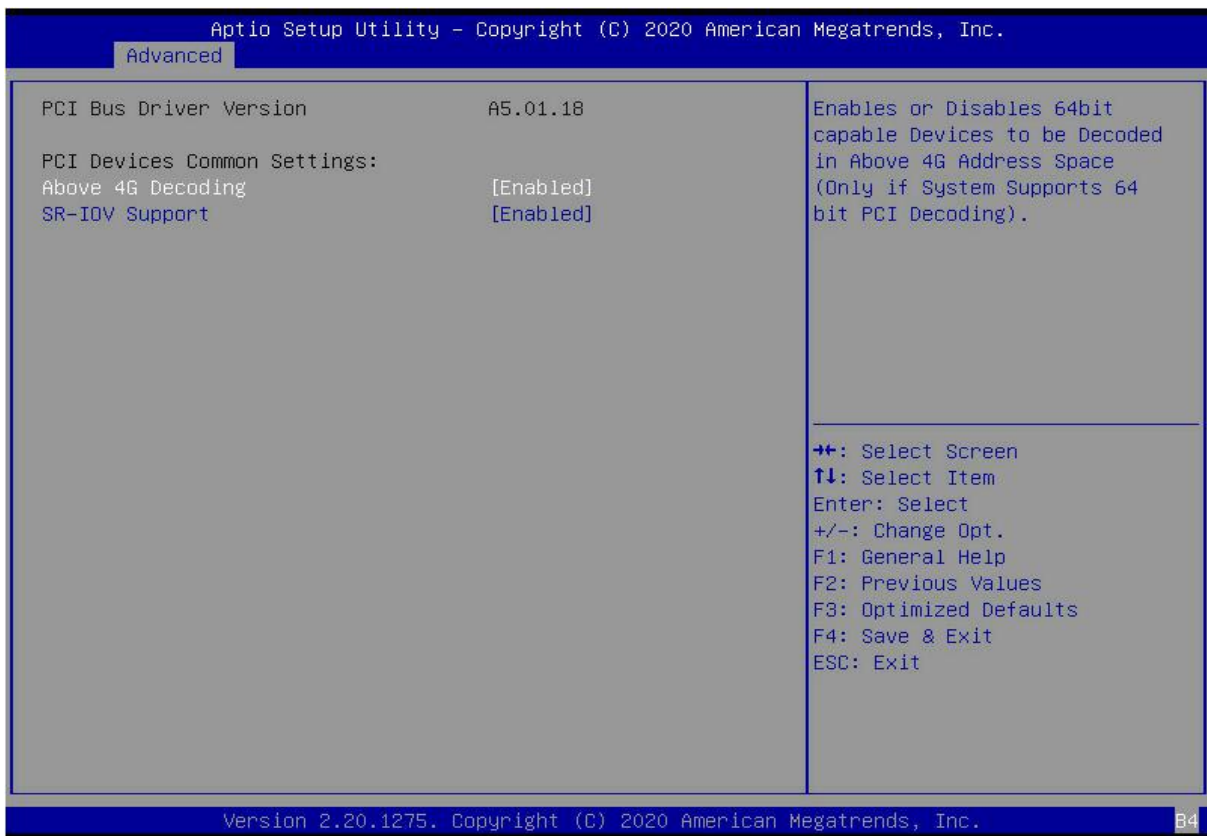

Figure 5- 9

Above 4G Decoding

The decoding control switch of memory space resources above 4G, the menu options are:

Enabled

Disabled

Default value: Enabled

SR-IOV Support

SR-IOV supports switch settings, the menu options are:

Enabled

Disabled

Default: Enabled

5.2.11 CSM Configuration

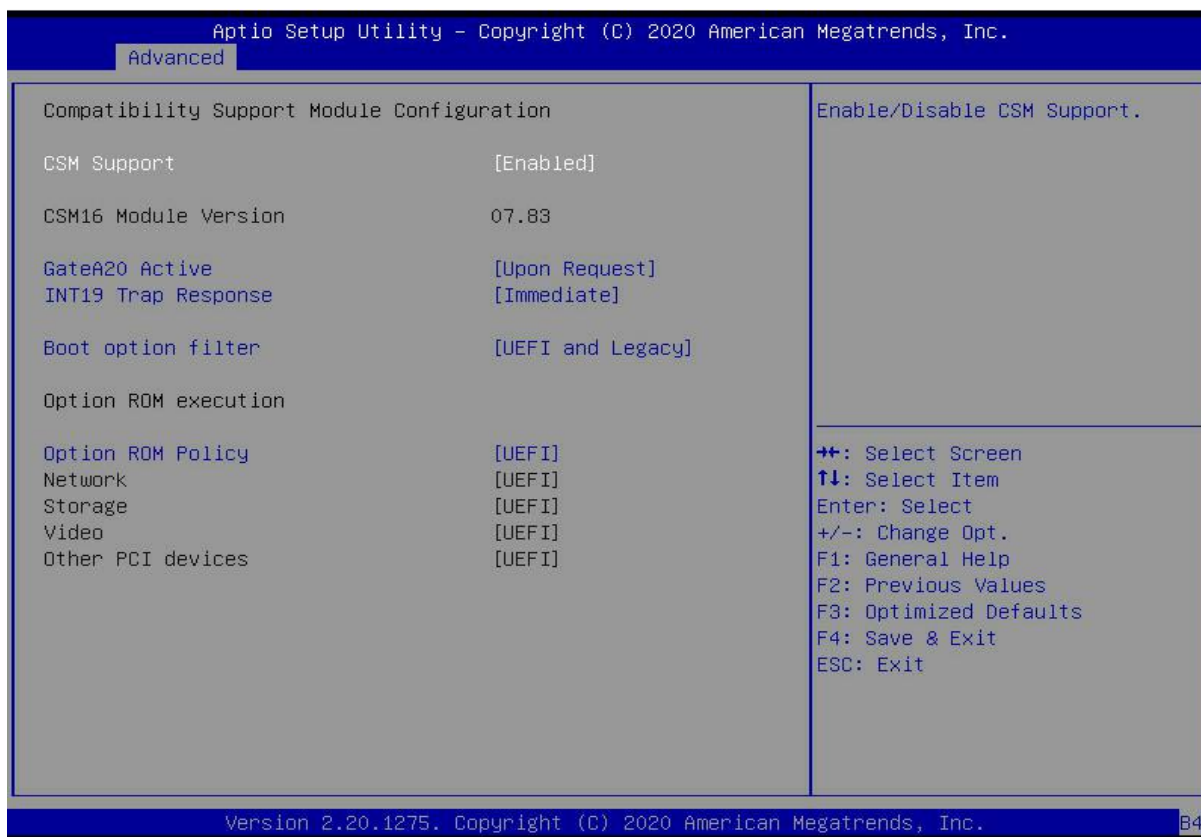

Figure 5-10

CSM Support

To enable or disable compatible support modules, the menu options are:

Disabled

Enabled

Default: Enabled

GateA20 Active

The control mode setting of the A20 address line, the menu options are:

Upon Request: if needed

Always

Default: After Request

INT19 Trap Response

Interrupt, capture signal response settings, the menu options are:

Immediate: respond immediately

Postponed: Delayed response

Default: Immediate

Boot option filter

Startup option class control switch, the menu options are:

UEFI and Legacy: UEFI and Legacy Boot Items

UEFI only: UEFI Boot items

Legacy only: Legacy Boot items

Default: UEFI and Legacy

Option ROM Policy

Select the Option ROM execution method, the menu options are:

UEFI: UEFI mode

Legacy: Legacy Mode
 Default: UEFI

5.2.12 NVMe Configuration

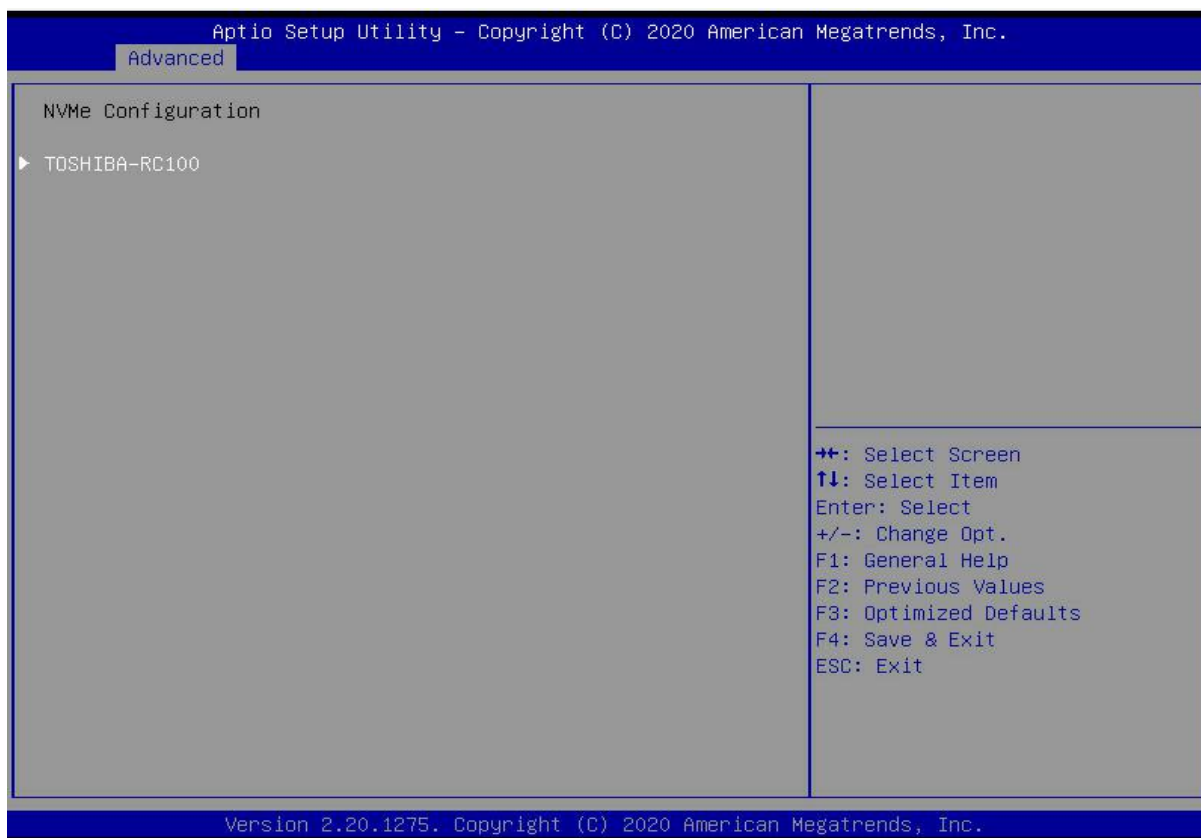

Figure 5- 11

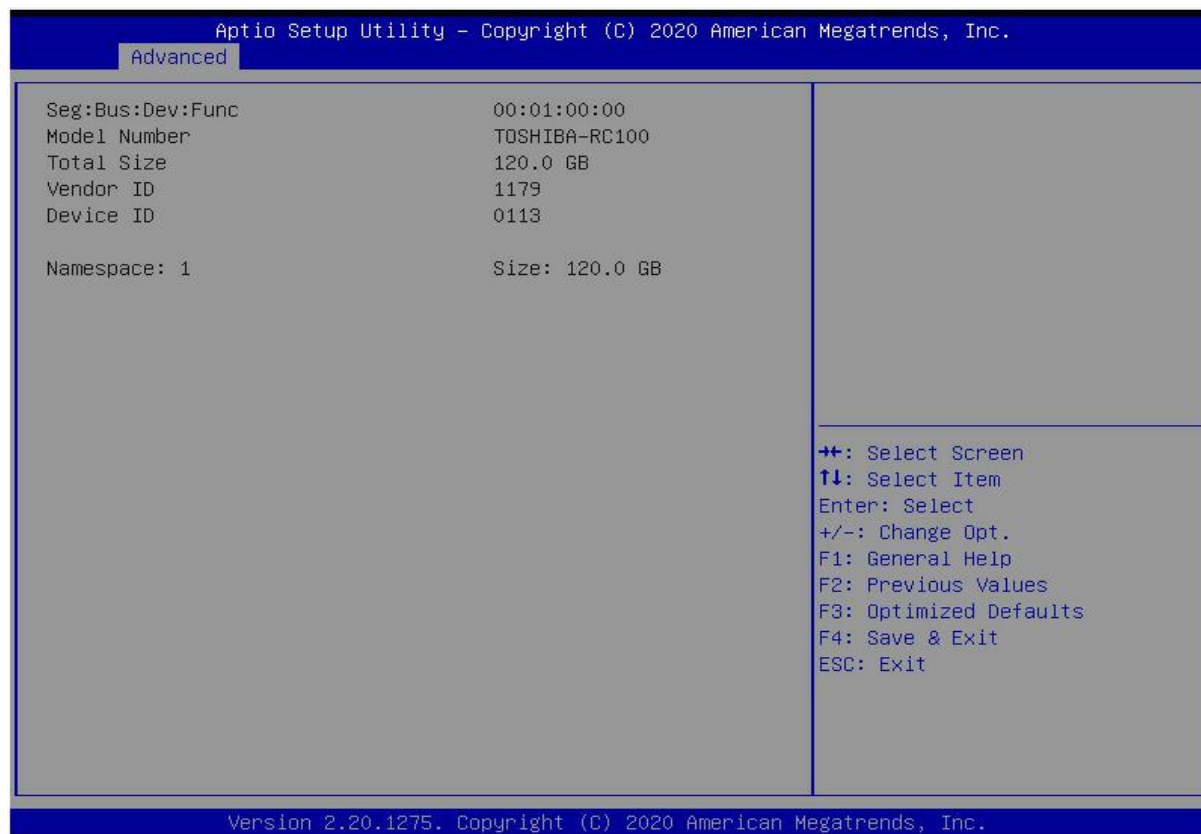

Figure 5- 12

Displays detailed information about NVMe hard drives.

5.2.13 Network Stack Configuration

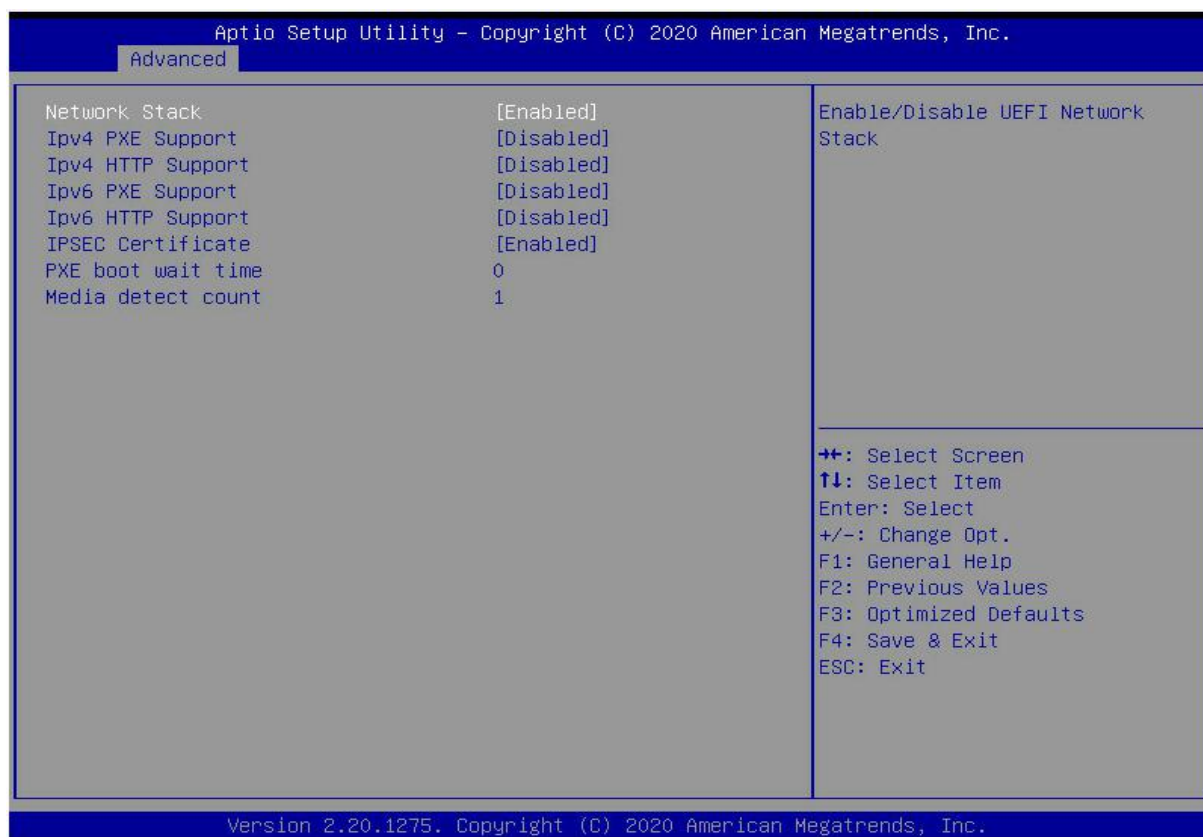

Figure 5- 13

Network Stack

Network stack control switch, the menu options are:

Enabled

Disabled

Default: Disabled

Ipv4 PXE Support

Ipv4 UEFI PXE function control switch, the menu options are:

Enabled

Disabled

Default: Disabled

Ipv4 HTTP Support

Ipv4 HTTP function control switch, the menu options are:

Enabled

Disabled

Default: Disabled

IPv6 PXE Support

IPv6 UEFI PXE function control switch, the menu options are:

Enabled

Disabled

Default: Disabled

Ipv6 HTTP Support

Ipv6 HTTP function control switch, the menu options are:

Enabled

Disabled

Default: Disabled

PXE boot wait time

PXE startup waiting time, the user can input the PXE startup waiting time, and can press "ESC" to give up PXE startup during the waiting process, the default is 0.

Media detect count

The number of device presence detections, the user can input the number of device network card device detections, the default is 1.

5.2.14 iSCSI Configuration

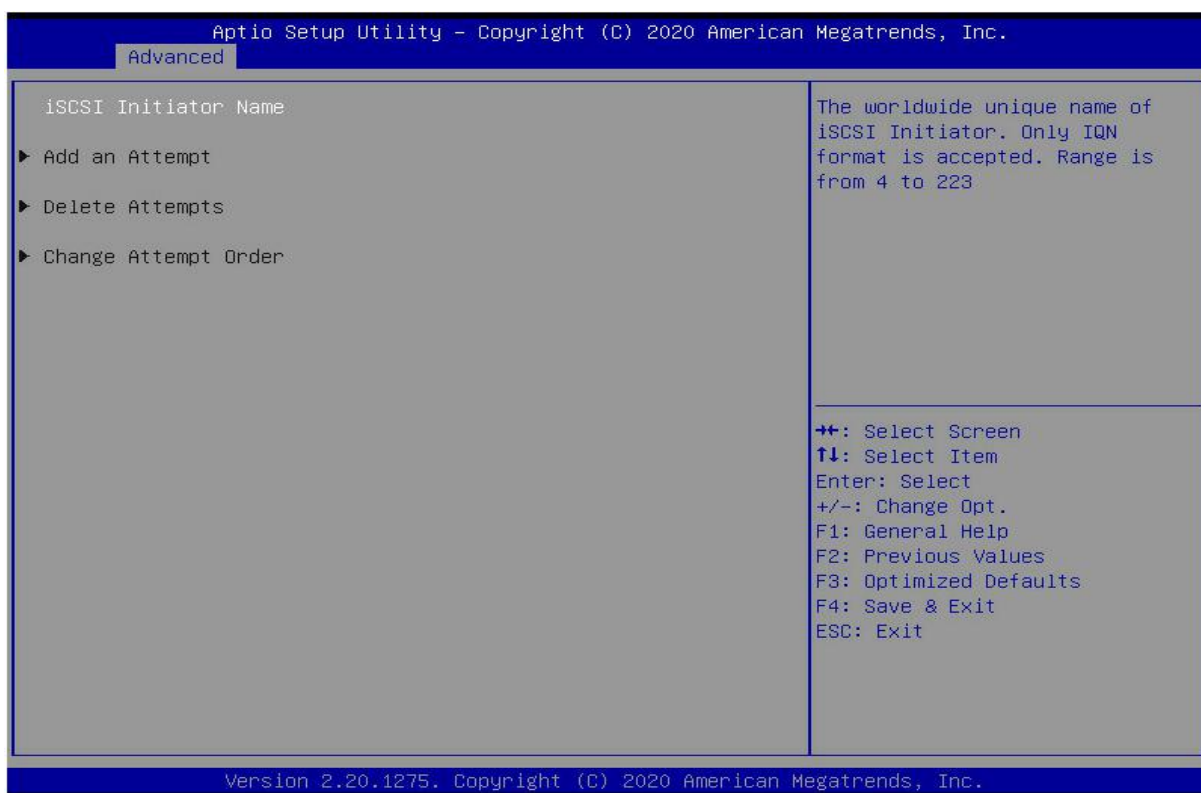

Figure 5- 14

iSCSI configuration

5.2.15 Platform Configuration menu

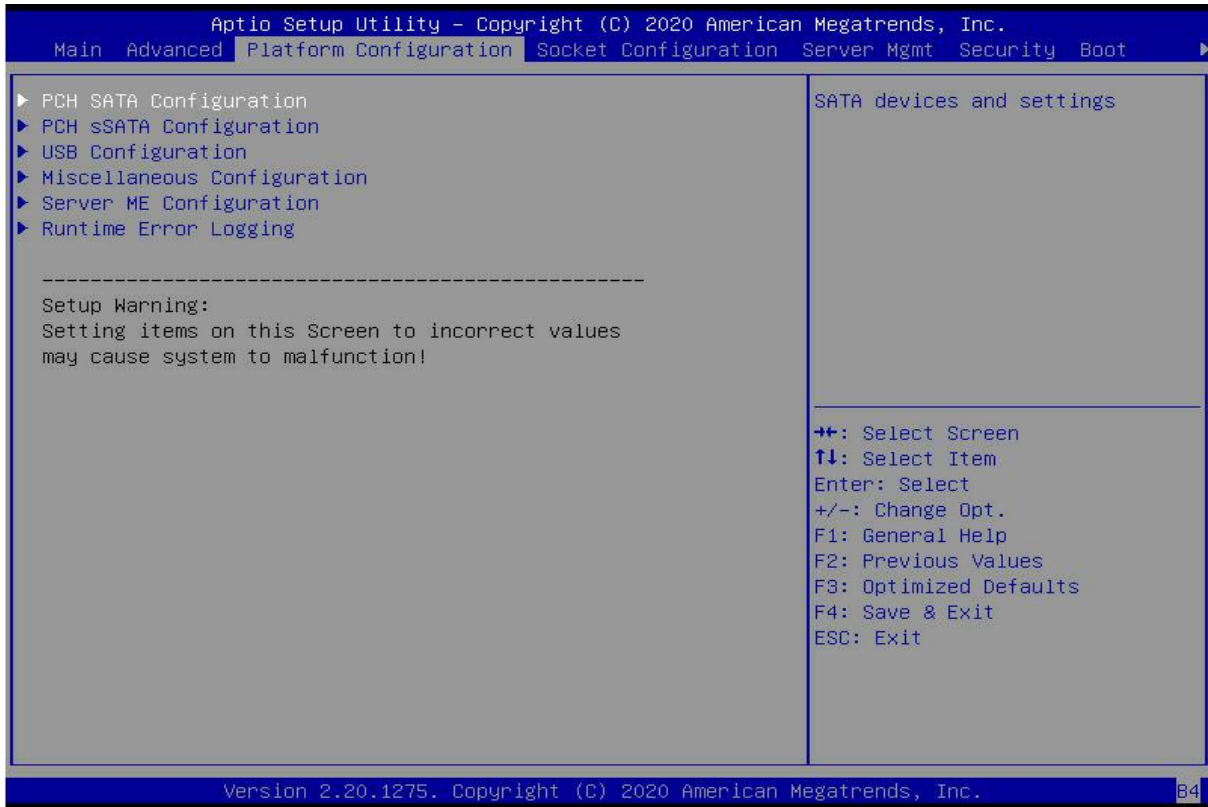

Figure 5- 15

PCH SATA Configuration

PCH sSATA Configuration

USB Configuration

Miscellaneous Configuration

Server ME Configuration

Runtime Error Logging

5.2.16 PCH SATA Configuration

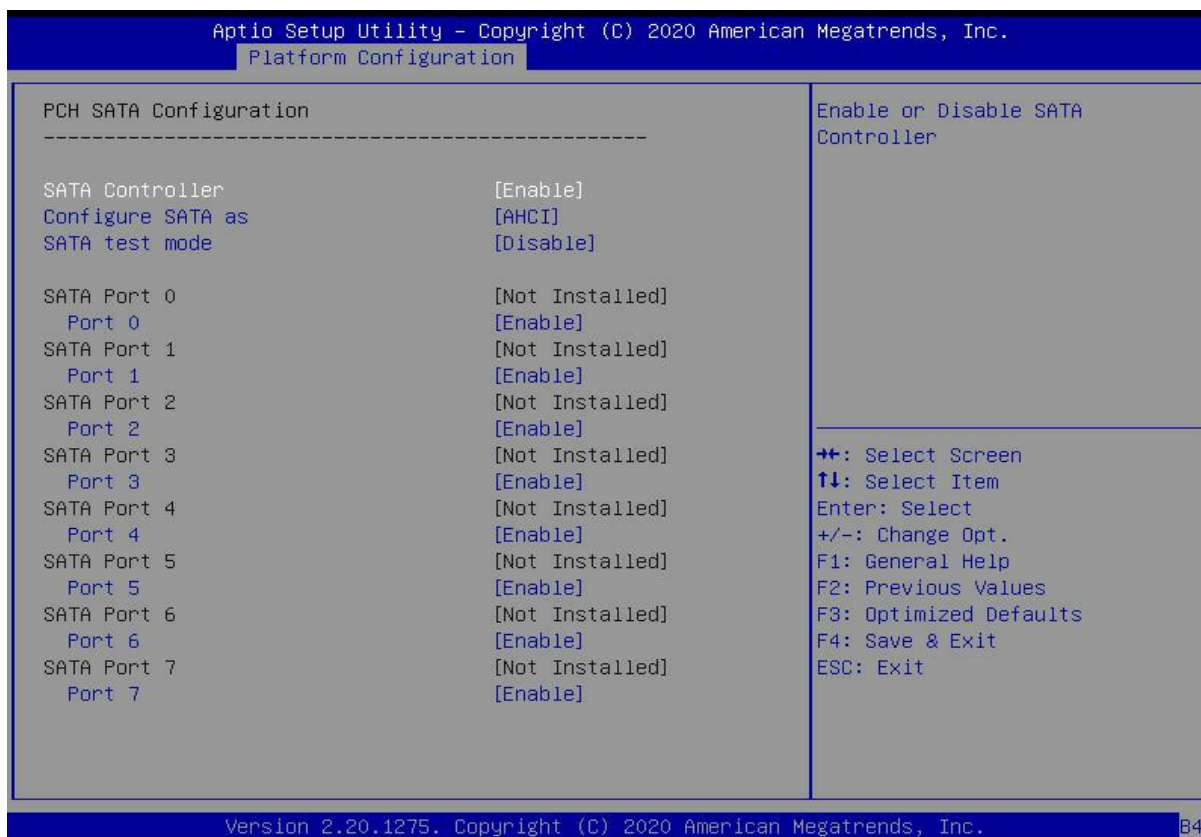

Figure 5- 16

SATA Controller

SATA controller switch, control to turn on and off the SATA controller, the menu options are:

Disabled: Disable the SATA controller.

Enabled: Enable the SATA controller.

Default: Enabled

Configure SATA as

SATA mode selection, the menu options are:

AHCI: Select SATA mode as AHCI mode.

RAID: Select SATA mode as RAID mode.

Default: AHCI

SATA test mode

SATA test mode switch, the menu options are:

Disabled

Enable

Default: Disable

SATA Port X

Displays device information on SATA Port 0~7, and displays Not Installed when no device is connected.

Port X

To control the opening and closing of SATA Port X, the menu options are:

Disabled: Disable SATA Port X.

Enabled: Enable SATA Port X.

Default: Enabled

Hot Plug

Control the hot plug function of SATA Port X device on and off, the menu options are:

Disabled: Disable the SATA Port X hot-plug function.

Enabled: Enable SATA Port X hot plug function.

Default: Enabled

5.2.17 PCH sSATA Configuration

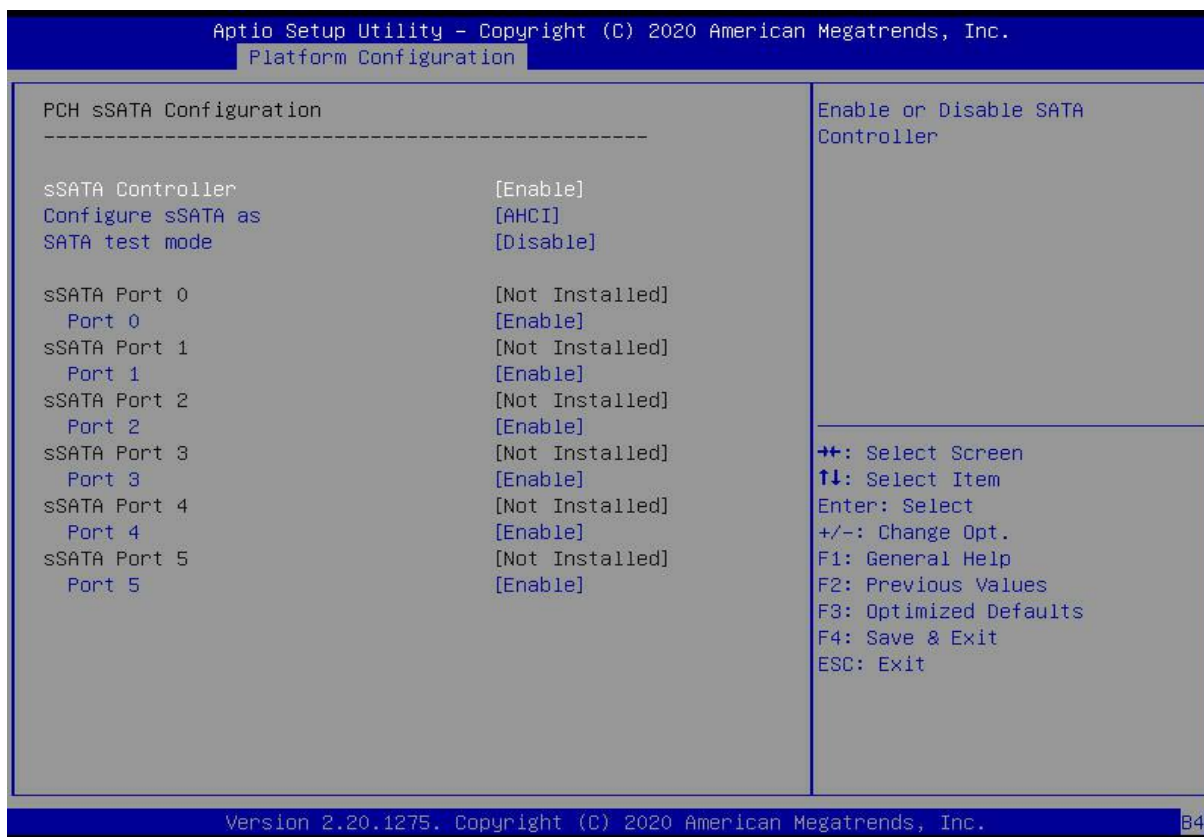

Figure 5- 17

ssATA Controller

ssATA controller switch, control to turn on and off the ssATA controller, the menu options are:

Disabled: Disable the ssATA controller.

Enabled: Enable the ssATA controller.

Default: Enabled

Configure ssATA as

ssATA mode selection, the menu options are:

AHCI: Select ssATA mode as AHCI mode.

RAID: Select ssATA mode as RAID mode.

Default: AHCI

SATA test mode

SATA test mode switch, the menu options are:

Disabled

Enable

Default: Disable

ssATA Port X

Displays device information on ssATA Port 0~7, and displays Not Installed when no device is

connected.

Port X

To control the opening and closing of sSATA Port X, the menu options are:

Disabled: Disable sSATA Port X.

Enabled: Enable sSATA Port X.

Default: Enabled

5.2.18 USB Configuration

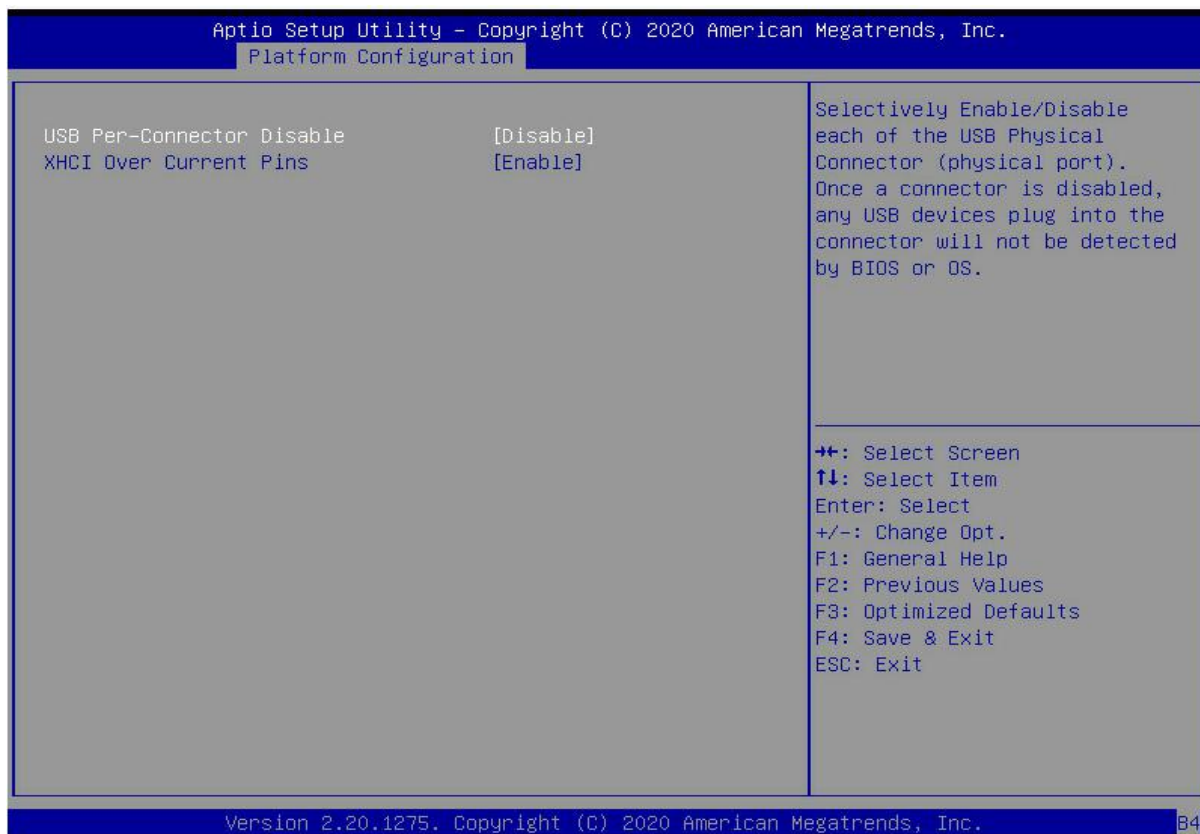

Figure 5- 18

USB Per-Connector Disable

For each USB connector switch, the menu options are:

Enable

Disable

Default: Disable

XHCI Over Current Pins

XHCI overcurrent pin switch, the menu options are:

Enable

Disable

Default: Enable

5.2.19 Miscellaneous Configuration



Figure 5- 19

PCH state after G3

PCH state setting after G3, the menu options are:

S0: Power on directly

S5: You need to press the Power button to turn on the power
leave power state unchanged: keep the power state unchanged

Default: S0

Max Page Table Size Select

To select the maximum page table size setting, the menu options are:

2M

1G

Default: 1G

Active Video

Select the active display device type, the menu options are:

Auto

Onboard Device

PCIE Device

Default: Auto

5.2.20 Server ME Configuration

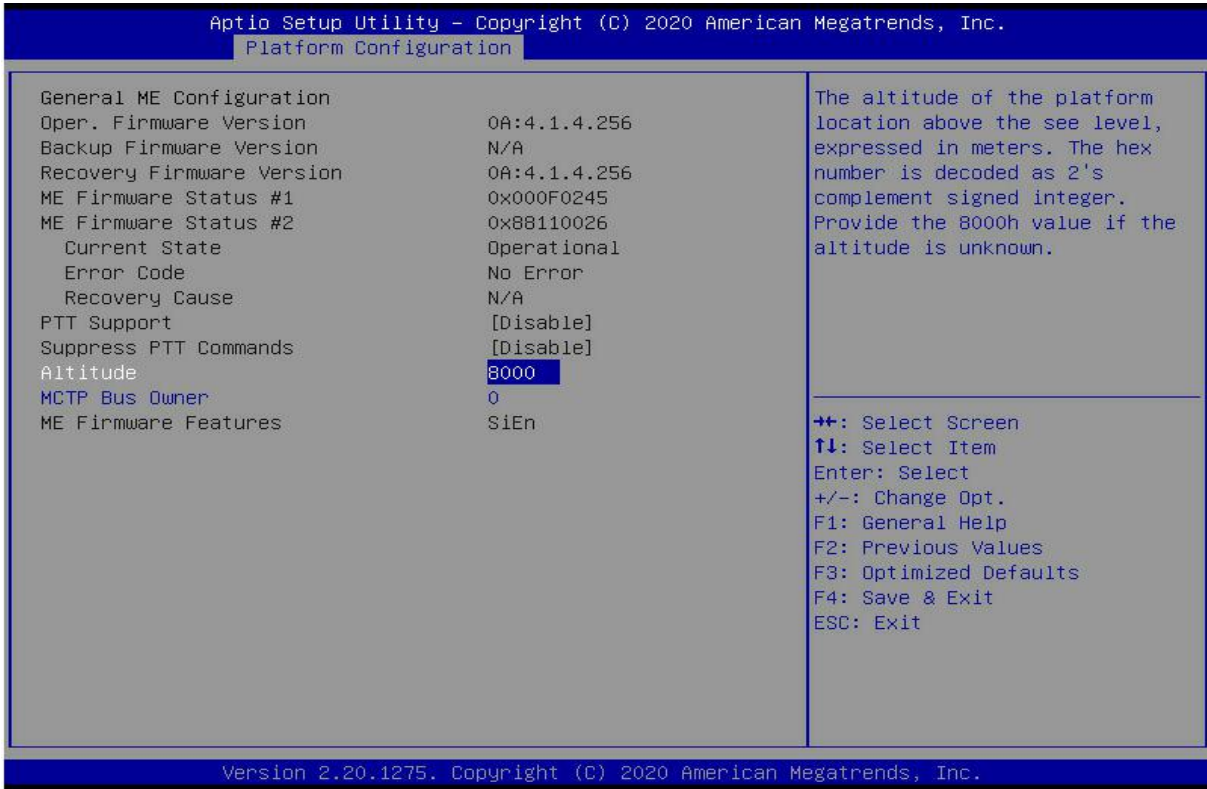

Figure 5- 20

Display Server ME version, features, status and other information;

5.2.21 Runtime Error Logging

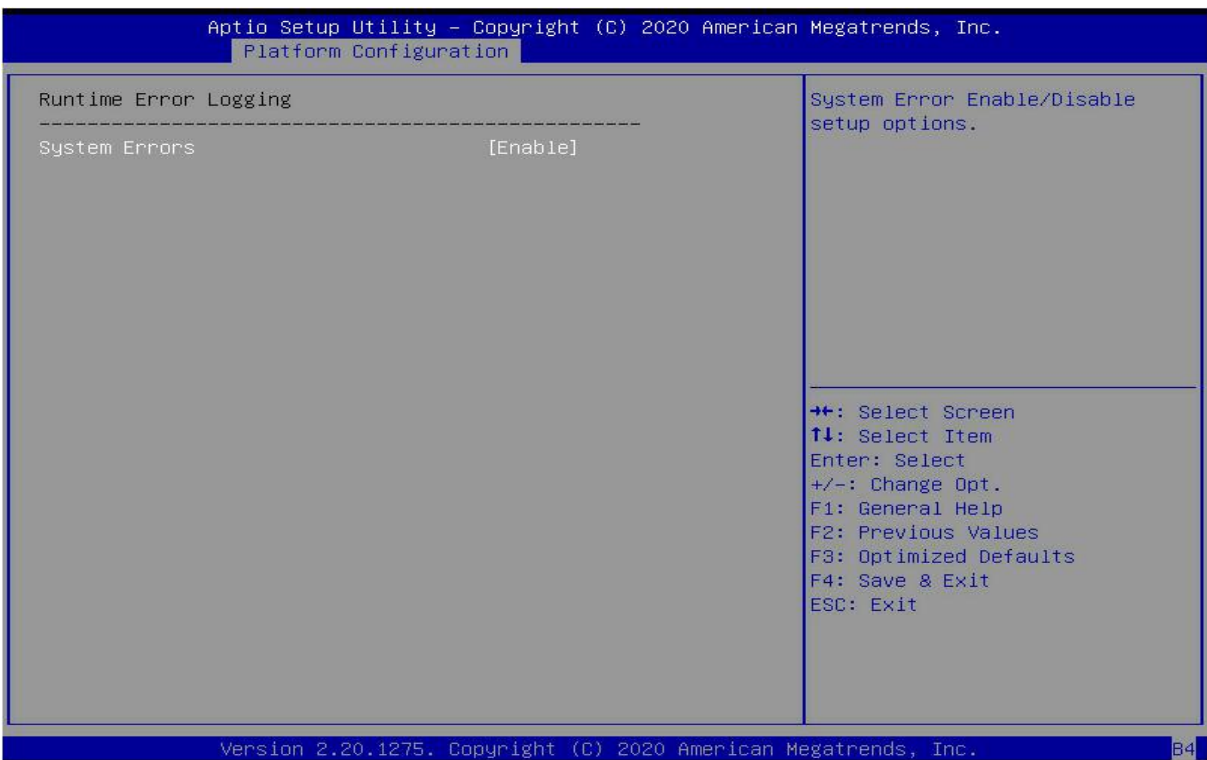

Figure 5- 21

System Errors

Turn on or off the system error function, the menu options are:

Disabled

Enabled

Default: Enabled

5.2.22 Socket Configuration menu

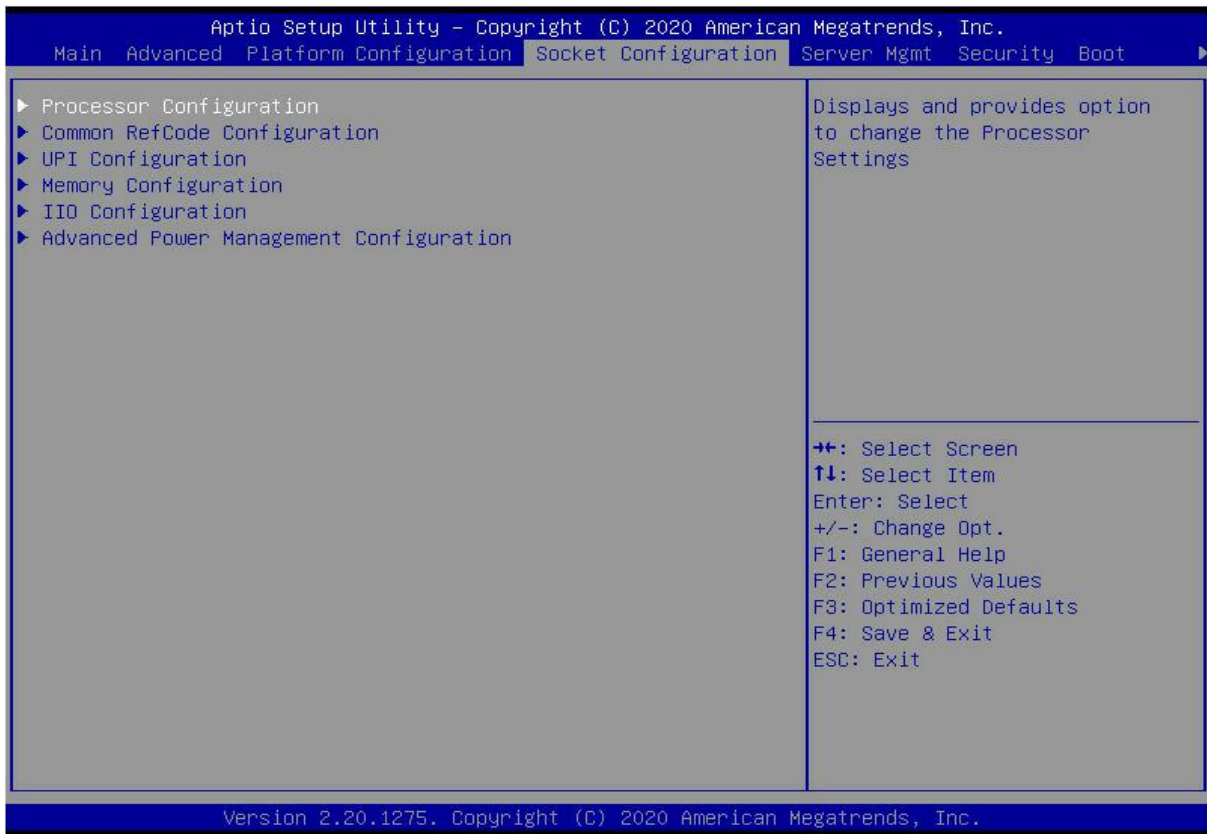

Figure 5- 22

Processor Configuration

Common RefCode Configuration

UPI Configuration

Memory Configuration

IIO Configuration

Advanced Power Management Configuration

5.2.23 Processor Configuration

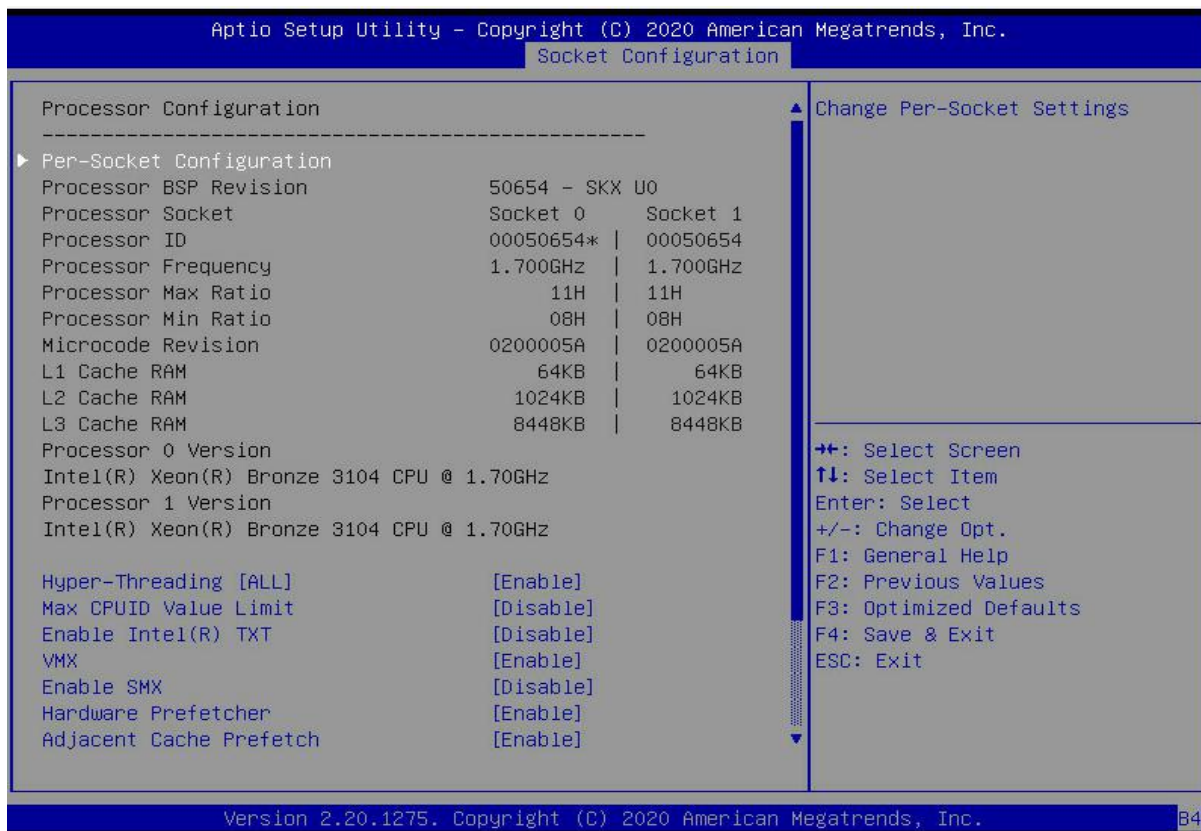

Figure 5- 23

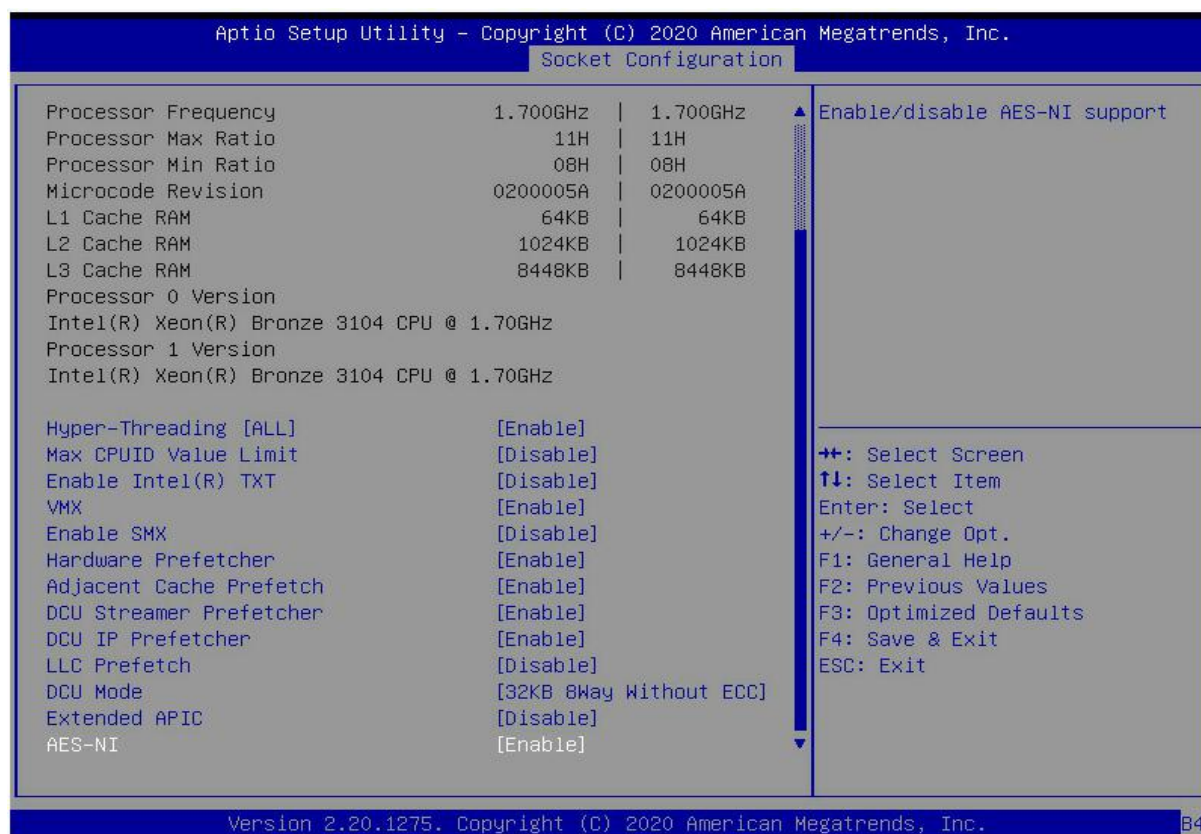

Figure 5- 24

Display CPU Type\ID\Speed\Cache and other information, configure CPU-related functions;
 Pre-Socket Configuration: each slot configuration;

Hyper-Threading

Hyper-Threading Control Switch, this option enables or disables the Hyper-Threading feature of Intel processors. When this feature is enabled, each physical processor core is equivalent to two logical processor cores; when this feature is disabled, each physical processor core is equivalent to only one logical processor core. Enabling this feature results in a higher processor core count, improving the overall performance of the application. The menu options are:

- Enable
- Disable
- Default: Enable

Max CPUID Value Limit

Enabled when booting a legacy operating system that cannot support extended CPUIDs, the menu options are:

- Enable
- Disable
- Default: Disable

Enable Intel(R) TXT

Intel TXT function switch, the menu options are:

- Enable
- Disable
- Default: Disable

VMX

CPU Virtualization Technology switch, if this option is enabled, the virtualization layer or operating system that supports this option can use the hardware capabilities of Intel Virtualization Technology. Some virtualization layers require Intel Virtualization Technology to be enabled. This option can also be left enabled without using a hypervisor or operating system that supports this option. The menu options are:

- Enable
- Disable
- Default: Enable

Enable SMX

Extended safe mode function switch, the menu options are:

- Enable
- Disable
- Default: Disable

Hardware Prefetcher

Hardware prefetching means that before the CPU processes instructions or data, it prefetches these instructions or data from memory to the L2 cache, thereby reducing memory read time, helping to eliminate potential bottlenecks, and improving system performance. The menu options are:

- Enable
- Disable
- Default: Enable

Adjacent Cache Prefetch

After the adjacent cache prefetch function is enabled, when the computer reads data, it will intelligently think that the data next to or adjacent to the data to be read is also needed, so these adjacent data will be pre-read during processing. , which can speed up reading. When the application scenario is to access memory sequentially, enabling this function will improve performance. When the application scenario is random access to memory, it is recommended to disable this option. The menu options are:

- Enable

Disable

Default: Enable

DCU Streamer Prefetcher

DCU stream prefetch switch, the menu options are:

Enable

Disable

Default: Enable

DCU IP Prefetcher

DCU IP prefetch switch, the menu options are:

Enable

Disable

Default: Enable

LLC Prefetcher

LLC prefetch switch, the menu options are:

Enable

Disable

Default: Disable

DCU Mode

DCU mode setting, the menu options are:

32KB 8Way Without ECC: 32KB 8Way Without ECC

16KB 4Way With ECC: 16KB 4Way With ECC

Default: 32KB 8Way Without ECC

Extended APIC

To enable/disable extended APIC support, the menu options are:

Enable

Disable

Default: Disable

AES-NI

To enable and disable AES (Advanced Encryption Standard), the menu options are:

Enable

Disable

Default: Enable

5.2.24 Common RefCode Configuration

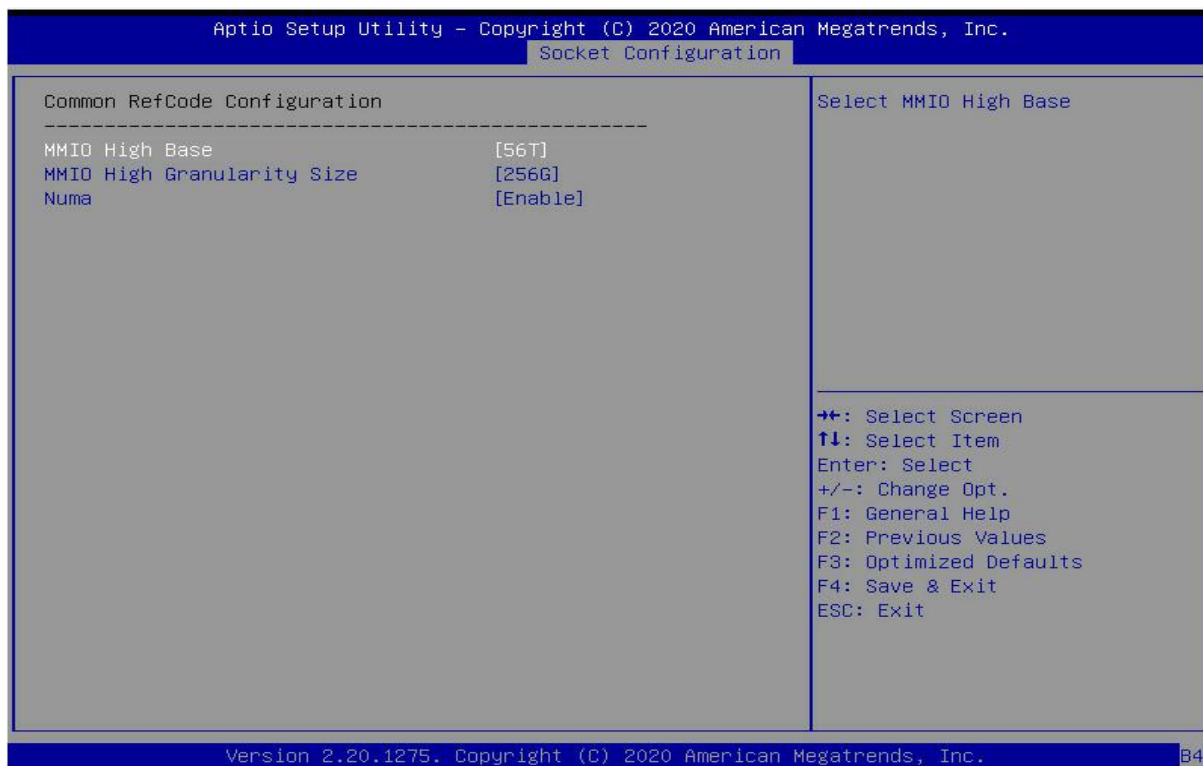

Figure 5- 25

MMIO High Base

Select the MMIO high base address, the menu options are:

56T
40T
24T
16T
4T
1T

Default: 56T

MMIO High Granularity Size

To select the MMIO high interval size, the menu options are:

1G
4G
16G
64G
256G
1024G

Default: 256G

Numa

To turn non-uniform memory access on or off, the menu options are:

Enable
Disable
Default: Enable

5.2.25 UPI Configuration

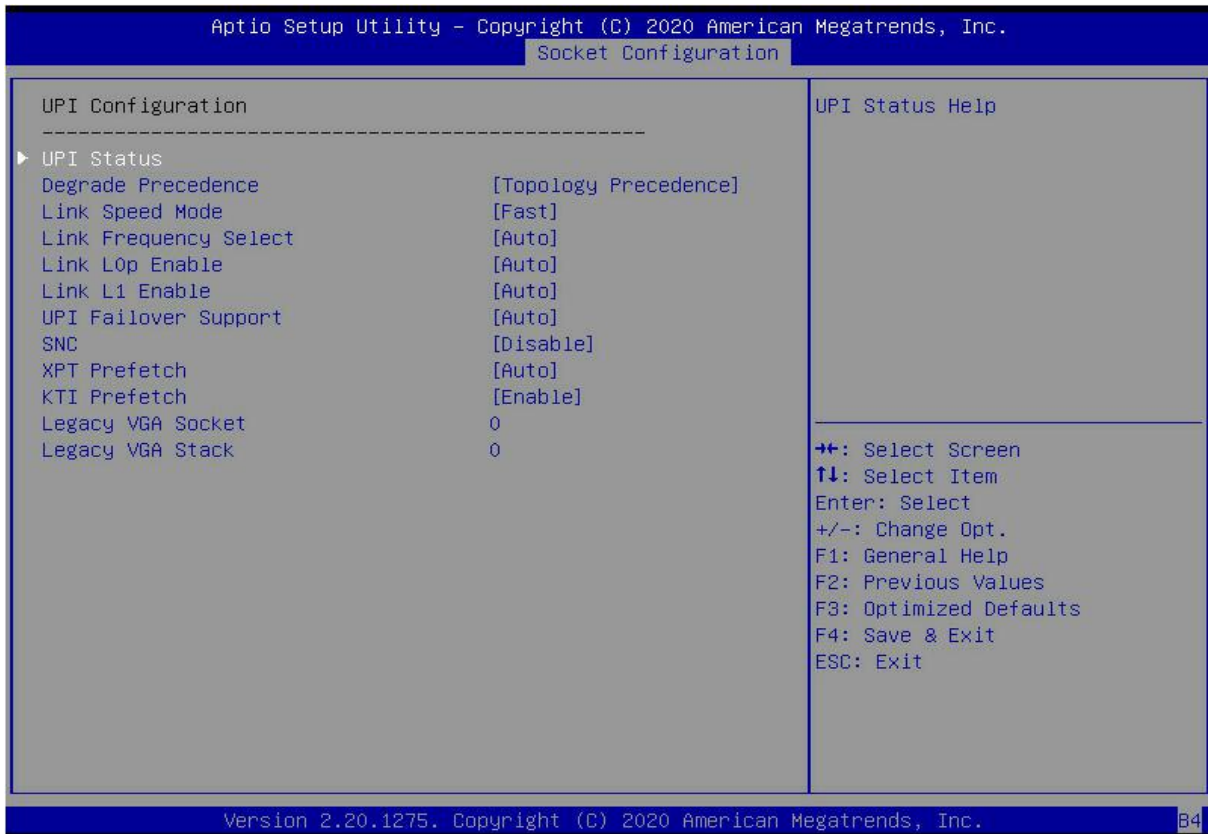

Figure 5- 26

UPI Status: UPI link status submenu, showing the current UPI link status

Degrade Precedence

When the system settings conflict, you can lower the feature by setting Topology Precedence, or lowering the Topology by setting Feature Precedence. The menu options are:

Topology Precedence

Feature Precedence

Default: Topology Precedence

Link Speed Mode

Link speed mode setting, the menu options are:

Slow

Fast

Default: Fast

Link L0p Enable

Link L0p switch, the menu options are:

Disable

Enable

Auto

Default: Auto

Link L1 Enable

Link L1 switch, menu options are:

Disable

Enable

Auto

Default: Auto

UPI Failover Support

UPI failover supports switch settings, the menu options are:

Disable

Enable

Auto

Default: Auto

SNC

Sub NUMA cluster settings, the menu options are:

Disable

Enable

Auto

Default: Disable

XPT Prefetch

XPT prefetch settings, the menu options are:

Disable

Enable

Auto

Default: Auto

KTI Prefetch

KTI prefetch settings, the menu options are:

Disable

Enable

Auto

Default: Enable

Legacy VGA Socket: Set the number of traditional VGA, the valid value range is 0~1.

Legacy VGA Stack : Set the number of traditional VGA stacks, the valid value range is 0~6.

5.2.26 Memory Configuration

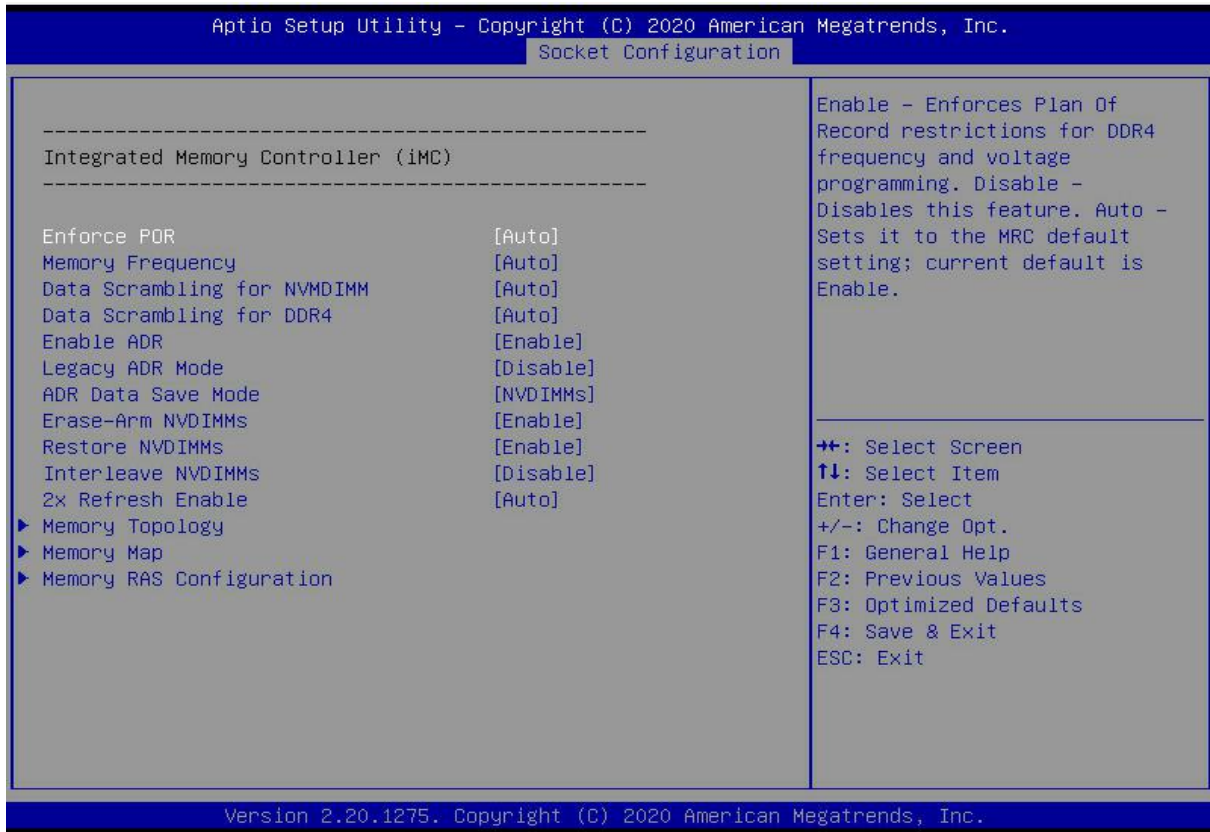

Figure 5- 27

Enforce POR

To enforce POR settings, the menu options are:

Auto

POR : execute POR

Disable

Default: Auto

Memory Frequency

Memory frequency setting, the menu options are:

Auto

800

1000

1066

1200

1333

1400

1600

...

Default: Auto

Data Scrambling for NVDIMMs

NVDIMM data scramble switch settings, the menu options are:

Auto

Disable

Enable

Default: Auto

Data Scrambling for DDR4

DDR4 data scramble switch settings, the menu options are:

Auto

Disable

Enable

Default: Auto

Enable ADR

ADR enable switch setting, the menu options are:

Disable

Enable

Default: Enable

Legacy ADR Mode

Traditional ADR mode switch settings, the menu options are:

Disable

Enable

Default: Enable

ADR Data Save Mode

ADR data saving mode setting, the menu options are:

Disable

Batterybacked DIMMs

NVDIMMs

Default: NVDIMMs

Erase-ARM NVDIMMs

Erase-ARM NVDIMMs switch settings, menu options are:

Disable

Enable

Default: Enable

Restore NVDIMMs

Fix NVDIMMs switch settings, menu options are:

Disable

Enable

Auto

Default: Auto

Interleave NVDIMMs

To interleave the NVDIMMs switch settings, the menu options are:

Disable

Enable

Default: Disable

2x Refresh Enable

2x refresh switch settings, the menu options are:

Disable

Enable

Default: Disable

Memory Topology

Memory topology submenu, showing in-place memory details;

Memory Map

Memory Map submenu;

Memory RAS Configuration

Memory RAS configuration submenu;

5.2.27 Memory Topology

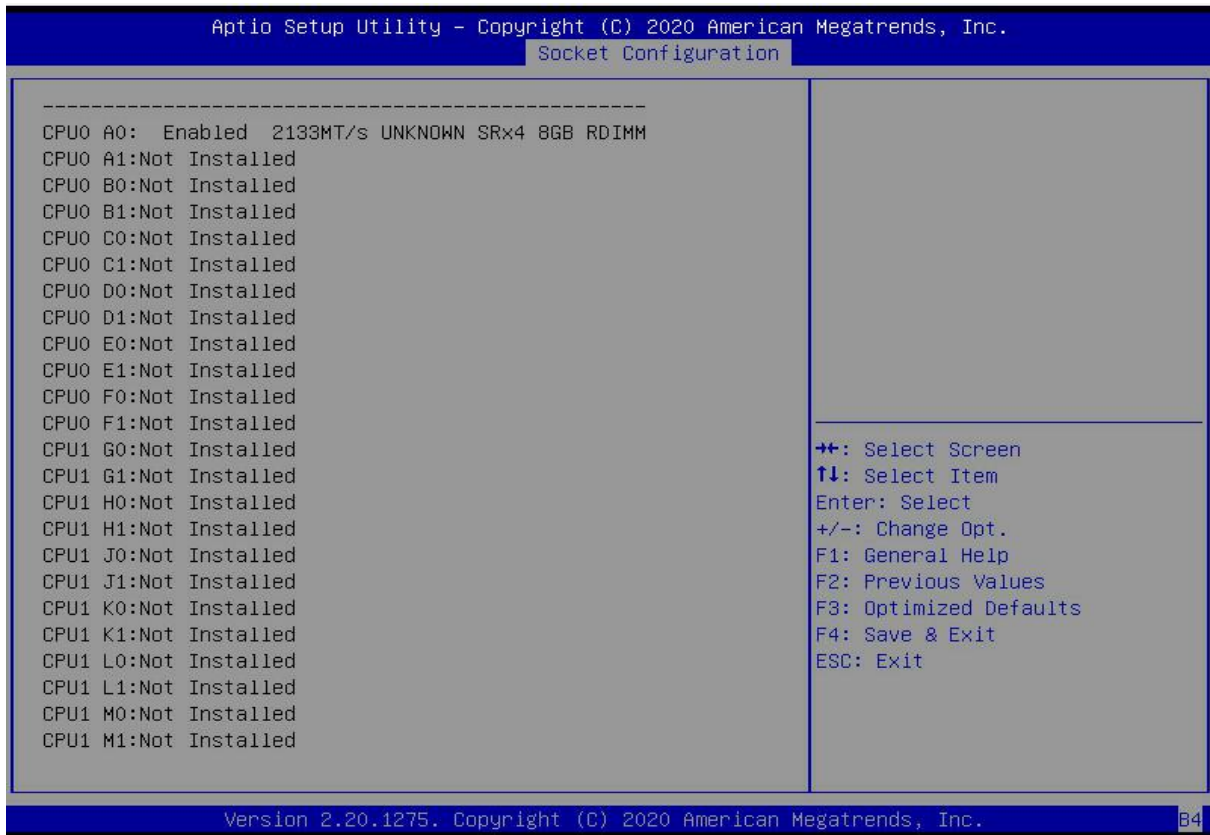

Figure 5- 28

Display current in-place memory details

5.2.28 Memory Map

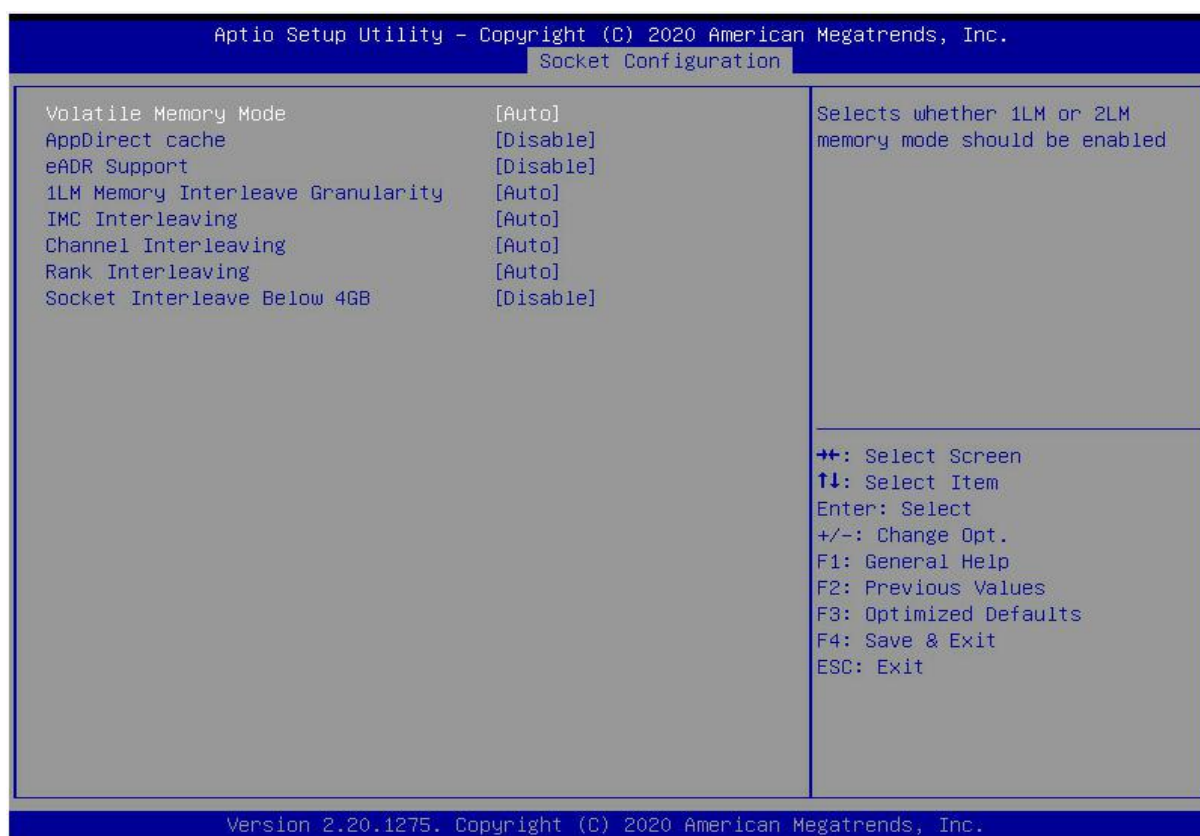

Figure 5- 29

Volatile Memory Mode

Volatile memory mode setting, the menu options are:

1LM

2LM

Auto

Default: Auto

1LM Memory Interleave Granularity

1LM memory interleaving interval setting, the menu options are:

Auto

256B Target, 256B Channel

64B Target, 64B Channel

Default: Auto

IMC Interleaving

IMC cross setting, the menu options are:

Auto

1-way Interleavel

2-way Interleavel

Default: Auto

Channel Interleaving

Channel cross setting, the menu options are:

Auto

1-way Interleavel

2-way Interleavel

3-way Interleavel

Default: Auto

Rank Interleaving

Rank cross setting, the menu options are:

Auto

1-way Interleavel

2-way Interleavel

4-way Interleavel

8-way Interleavel

Default: Auto

Socket Interleave Below 4GB

4GB address space processor interleave switch settings, the menu options are:

Enable

Disable

Default: Disable

5.2.29 Memory RAS Configuration

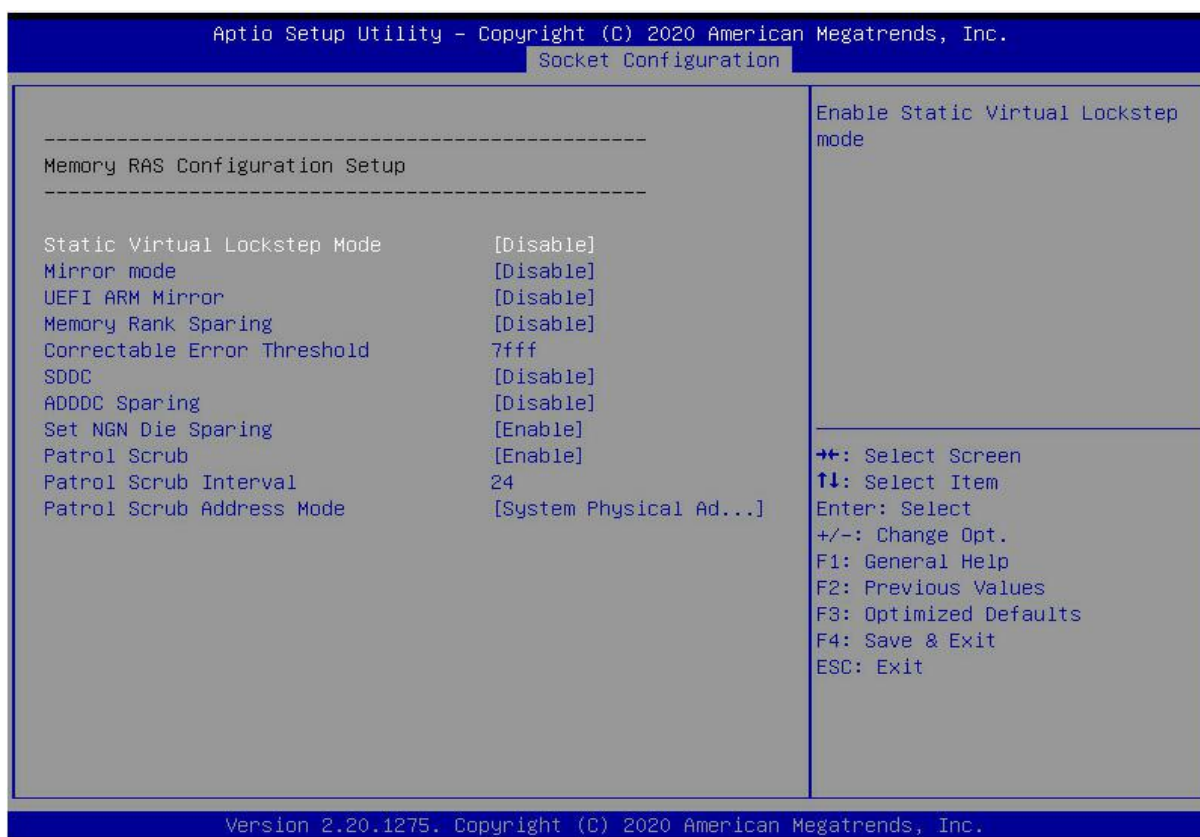

Figure 5- 30

Static Virtual Lockstep Mode

Static virtual Lockstep mode switch settings, the menu options are:

Enable

Disable

Default: Disable

Mirror Mode

Mirror mode settings, the menu options are:

Disable : disable

Enable Mirror Mode (1LM)

Default: Disable

UEFI ARM Mirror

UEFI ARM mirror mode switch settings, the menu options are:

Enable

Disable

Default: Disable

Memory Rank Sparing

Memory Rank hot spare switch settings, the menu options are:

Enable

Disable

Default: Disable

Correctable Error Threshold : Correctable error threshold, the valid value is 0x01-0x7fff, the default value is 0x7fff.

SDDC

SDDC switch setting, note: not supported when AEP DIMM exists, the menu options are:

Enable

Disable

Default: Disable

ADDDC Sparing

ADDDC hot standby switch settings, the menu options are:

Enable

Disable

Default: Disable

Set NGN Die Sparing

Set NGN Die hot standby switch settings, the menu options are:

Enable

Disable

Default: Enable

Patrol Scrub

Patrol Scrub switch settings, menu options are:

Enable

Disable

Default: Enable

Patrol Scrub Interval : Patrol Scrub interval time setting, the unit is hour, the range is 1-24, the default value is 24.

Patrol Scrub Address Mode

Patrol Scrub address mode setting, the menu options are:

Reverse address

System Physical Address

Default: System Physical Address

5.2.30 Ticket Configuration

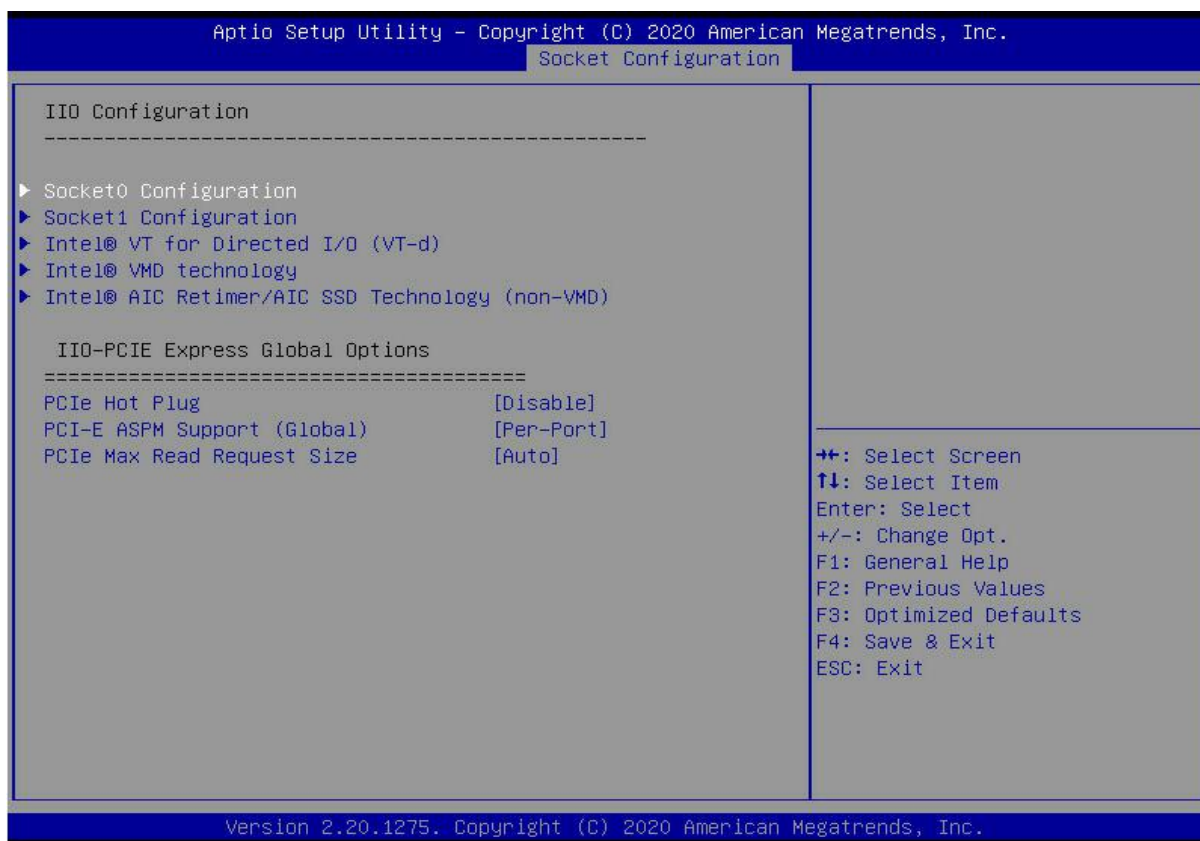

Figure 5- 31

SocketN Configuration

The SocketN configuration submenu is used to set the Link speed, Max Payload Size, ASPM and other settings of the device on the PCIE of CPU0, and display the link status of the current PCIE port, the maximum link, the current link rate, etc.;

Intel(R) VT for Directed I/O (VT-d)

Intel VT-d technology related settings submenu, Intel VT-d technology switch settings;

Intel(R) VMD Technology

Intel VMD technology related settings submenu, switch settings of VMD on each PStack of each CPU;

Intel(R) AIC Retimer/AIC SSD Technology(non-VMD)

Intel AIC Retimer/AIC SSD technology related settings submenu, switch settings of AIC Retimer/AIC SSD technology on each PStack of each CPU.

PCIe Hot Plug

PCIe hot-plug switch settings, the menu options are:

Enable

Disable

Default: Disable

PCI-E ASPM Support(Global)

PCI-E ASPM master switch settings, the menu options are:

Disable

Per-Port: each port

L1 Only

Default: Per-Port

PCI-E Max Read Request Size

PCI-E maximum read request size setting, the menu options are:

- Auto
- 128B
- 256B
- 512B
- 1024B
- 2048B
- 4096B
- Default: Auto

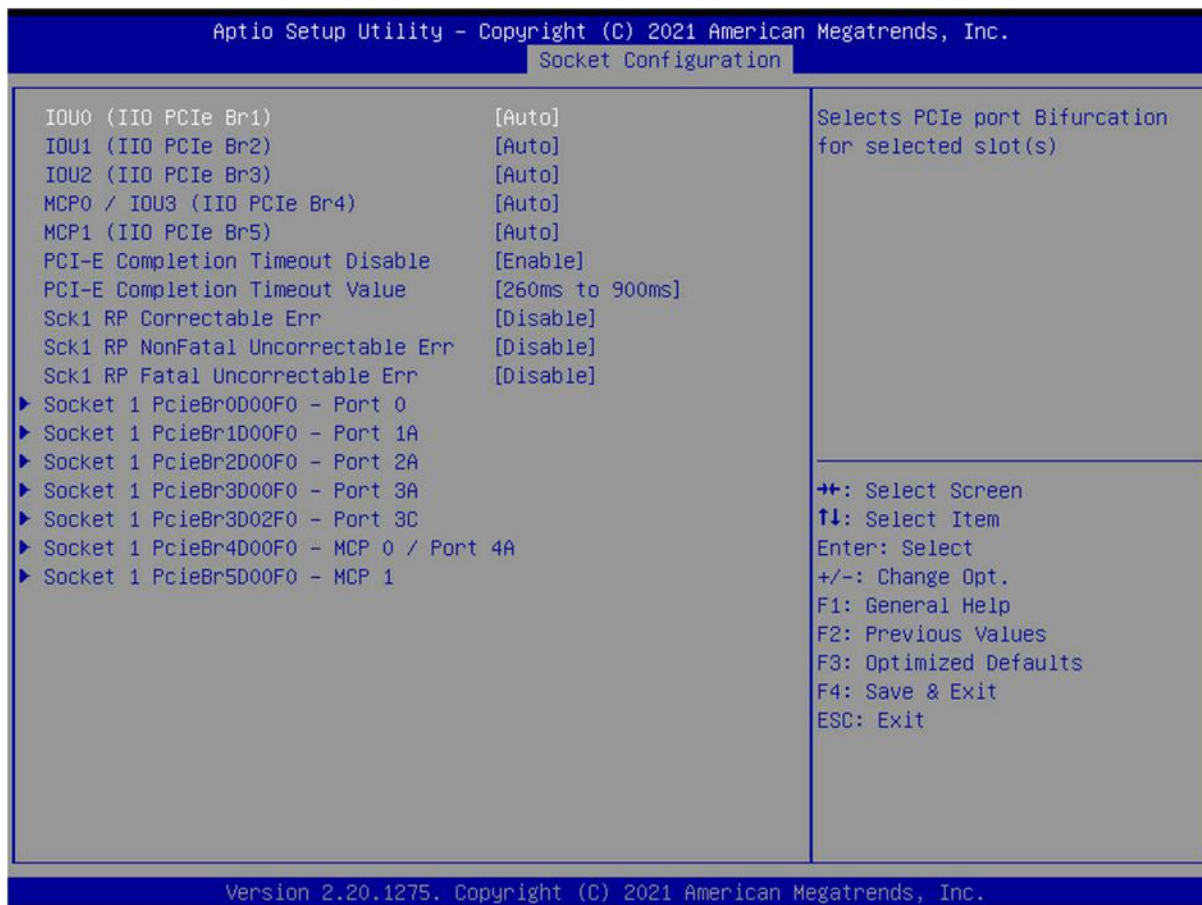

Socket0 Configuration

IOU0 (IIO PCIe Br1)

Control CPU 0 riser 1 x16 PCIe branch option;

IOU1 (IIO PCIe Br2)

Control CPU 0 riser 1 x8 and riser 2 x8 PCIe branch options;

IOU2 (IIO PCIe Br3)

Controls OCP NIC slots and PCIe breakout options linked to PCH upstream channels;

Socket 0 PcieBr0D00F0 – Port 0/DMI

CPU 0 is linked to the PCH's DMI channel configuration menu;

Socket 0 PcieBr1D00F0 – Port 1A

CPU 0 riser 1 x16 slot configuration menu;

Socket 0 PcieBr2D00F0 – Port 2A

CPU 0 riser 2 x8 slot configuration menu;

Socket 0 PcieBr2D02F0 – Port 2C

CPU 0 riser 1 x8 slot configuration menu;

Socket 0 PcieBr3D00F0 – Port 3A

CPU 0 OCP card slot configuration menu;

Socket 0 PcieBr3D02F0 – Port 3C

CPU 0 is linked to the configuration menu of the PCH upstream channel;

Socket1 Configuration

IOU0 (IIO PCIe Br1)

Control CPU 1 riser 3 x16 PCIE branch options;

IOU1 (IIO PCIe Br2)

Control CPU 1 riser 2 x16 PCIE branch options;

IOU2 (IIO PCIe Br3)

Control the PCIE branch options of CPU1 Slimline 1 and Slimline 2;

Socket 1 PcieBr0D00F0 – Port 0

Unused;

Socket 1 PcieBr1D00F0 – Port 1A

CPU 1 riser 3 x16 slot configuration menu;

Socket 1 PcieBr2D00F0 – Port 2A

CPU 1 riser 2 x16 slot configuration menu;

Socket 1 PcieBr3D00F0 – Port 3A

CPU1 Slimline 1 slot configuration menu;

Socket 1 PcieBr3D02F0 – Port 3C

CPU1 Slimline 2 slot configuration menu;

5.2.31 Advanced Power Management Configuration

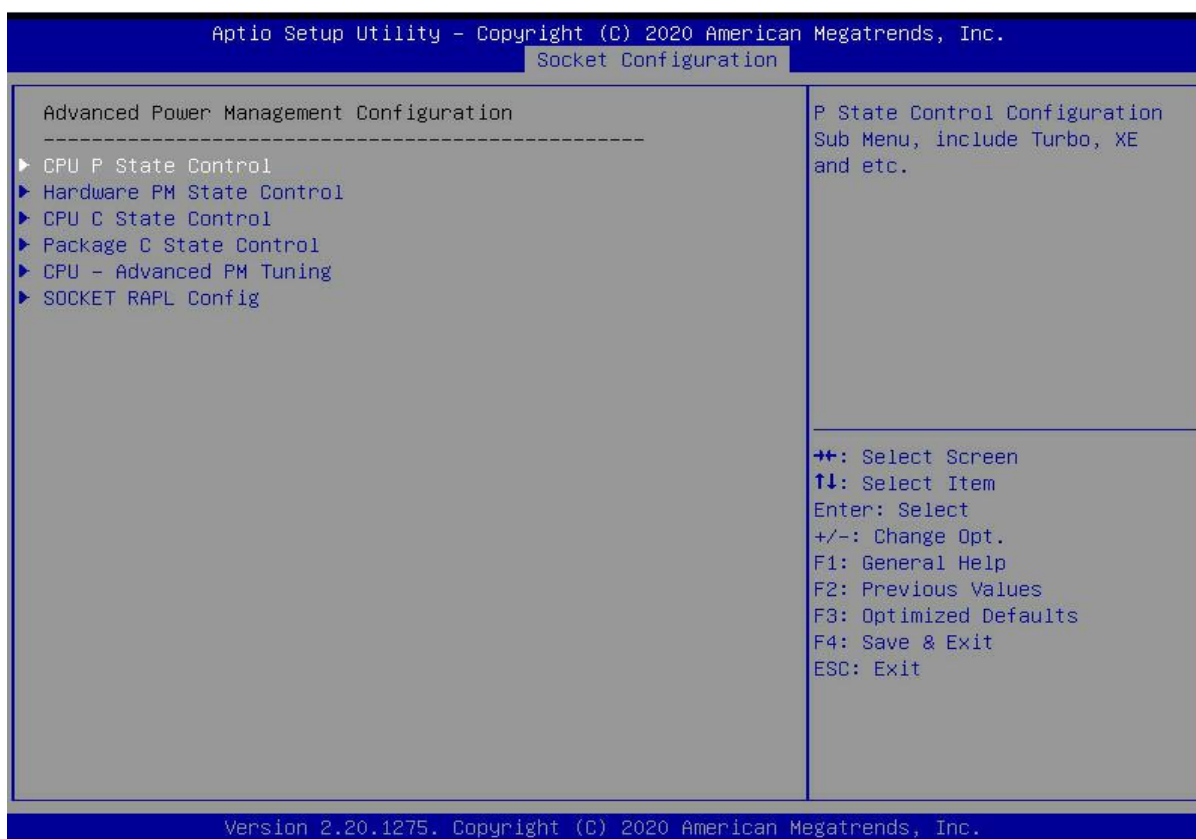

Figure 5- 32

CPU P State Control

CPU P state control setting submenu;

Hardware PM State Control

Hardware power management state control submenu;
 CPU C State Control
 CPU C state control setting submenu;
 Package C State Control
 Package C status control submenu;
 CPU-Advanced PM Tuning
 CPU performance and power saving tuning submenu;
 Socket RAPL Configuration
 Socket RAPL configuration submenu;

5.2.32 CPU P State Control

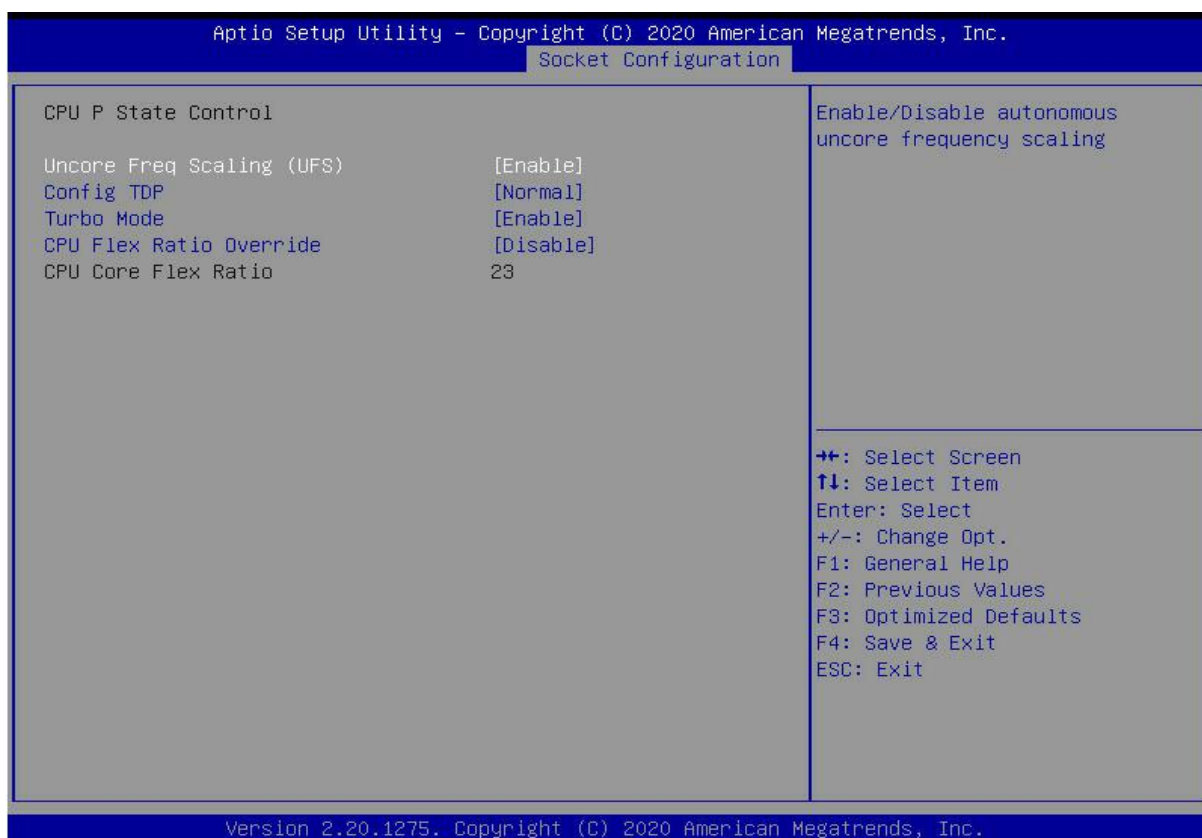

Figure 5- 33

Uncore Freq Scaling (UFS)

Uncore frequency extension settings, the menu options are:

Enable

Disable

Default: Enable

Config TDP

TDP level settings, the menu options are:

Normal

Level 1

Level 2

Default: Normal

Turbo Mode

Dynamic acceleration switch settings, the menu options are:

Enable

Disable
Default: Enable

5.2.33 Hardware PM State Control

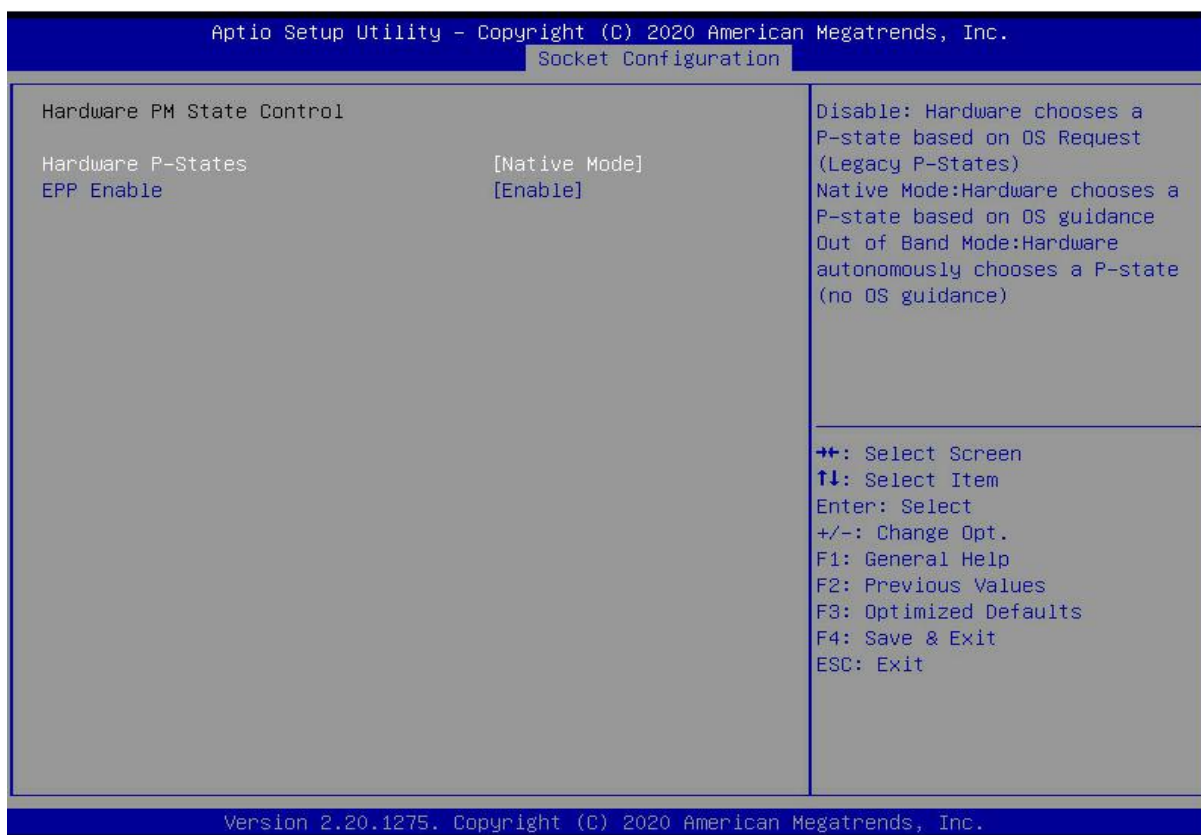

Figure 5- 34

Hardware P-State

The hardware selects whether the P-State state is actively set by the OS. The default value is determined according to the actual test. The menu options are:

Disable : Hardware selects P-States based on legacy OS requests

Native Mode: Hardware selection P-State based on legacy OS boot

Out of Band Mode: Hardware is automatically selected, no OS boot required

Native Mode with No Legacy Support

Default: Native Mode

EPP Enable

EPP enable setting, the menu options are:

Enable

Disable

Default: Enable

5.2.34 CPU C State Control

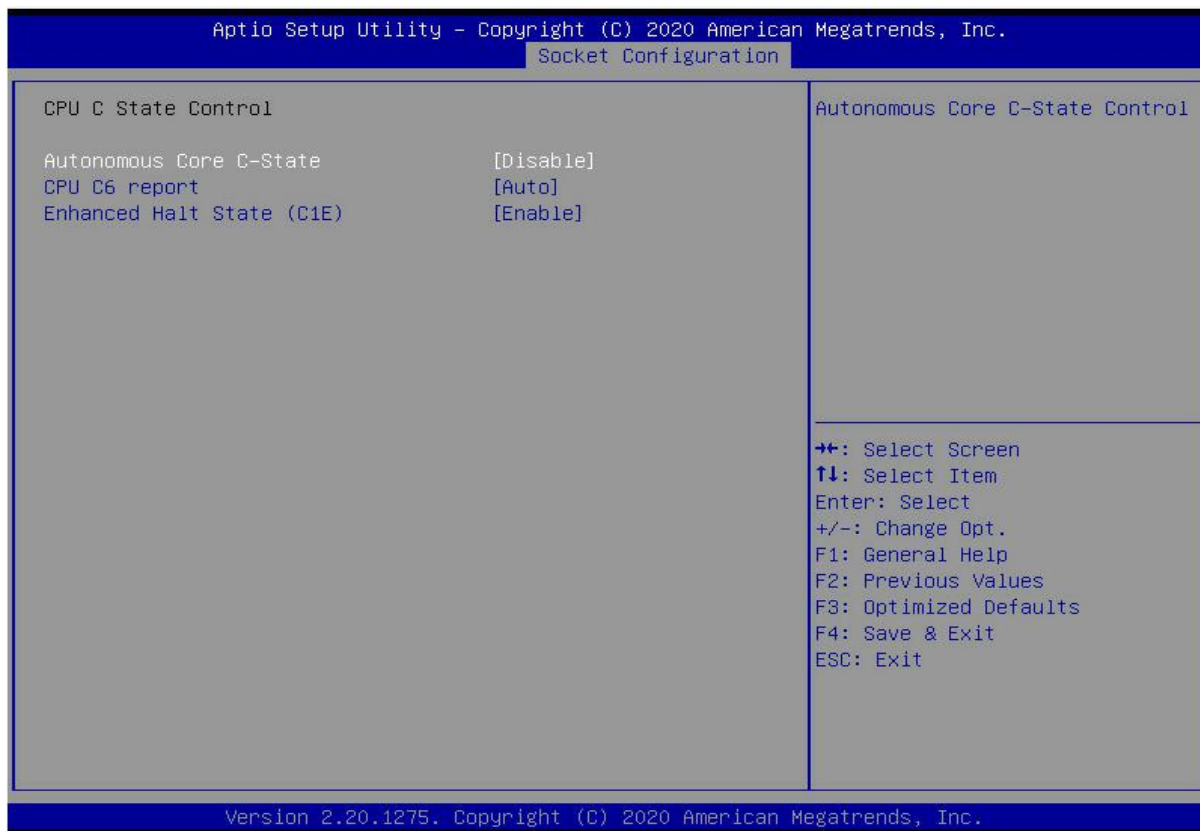

Figure 5- 35

Autonomous Core C-State

Autonomous core C state switch settings, the menu options are:

Enable

Disable

Default: Disable

CPU C6 report

Reports the C6 status switch settings to the OS, the menu options are:

Disable

Enable

Auto

Default: Auto

Enhanced Halt State (C1E)

C1E switch settings, the menu options are:

Disable

Enable

Default: Enable

5.2.35 Package C State Control

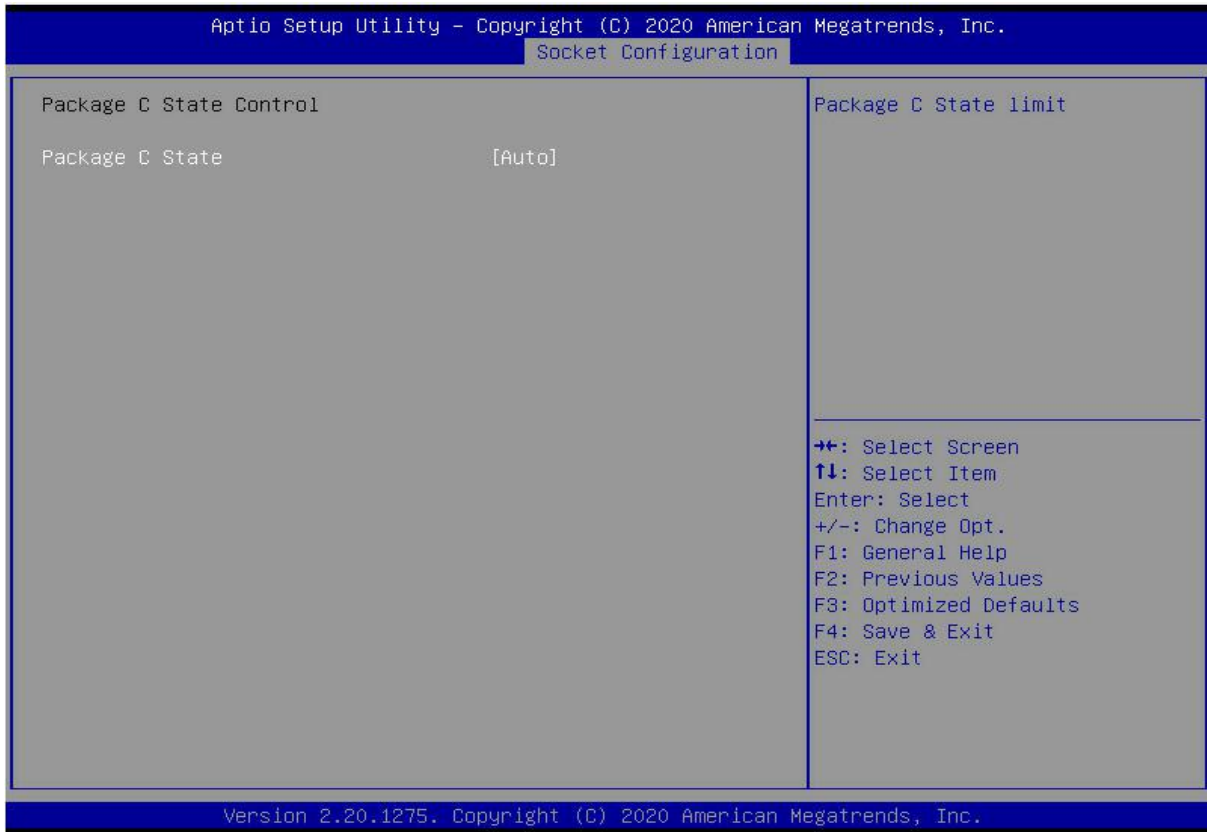

Figure 5- 36

Package C State

Package C status settings, the menu options are:

C0/C1 state

C2 state

C6(non Retention) state

C6(Retention) state

No Limit

Default: Auto

5.2.36 CPU-Advanced PM Tuning

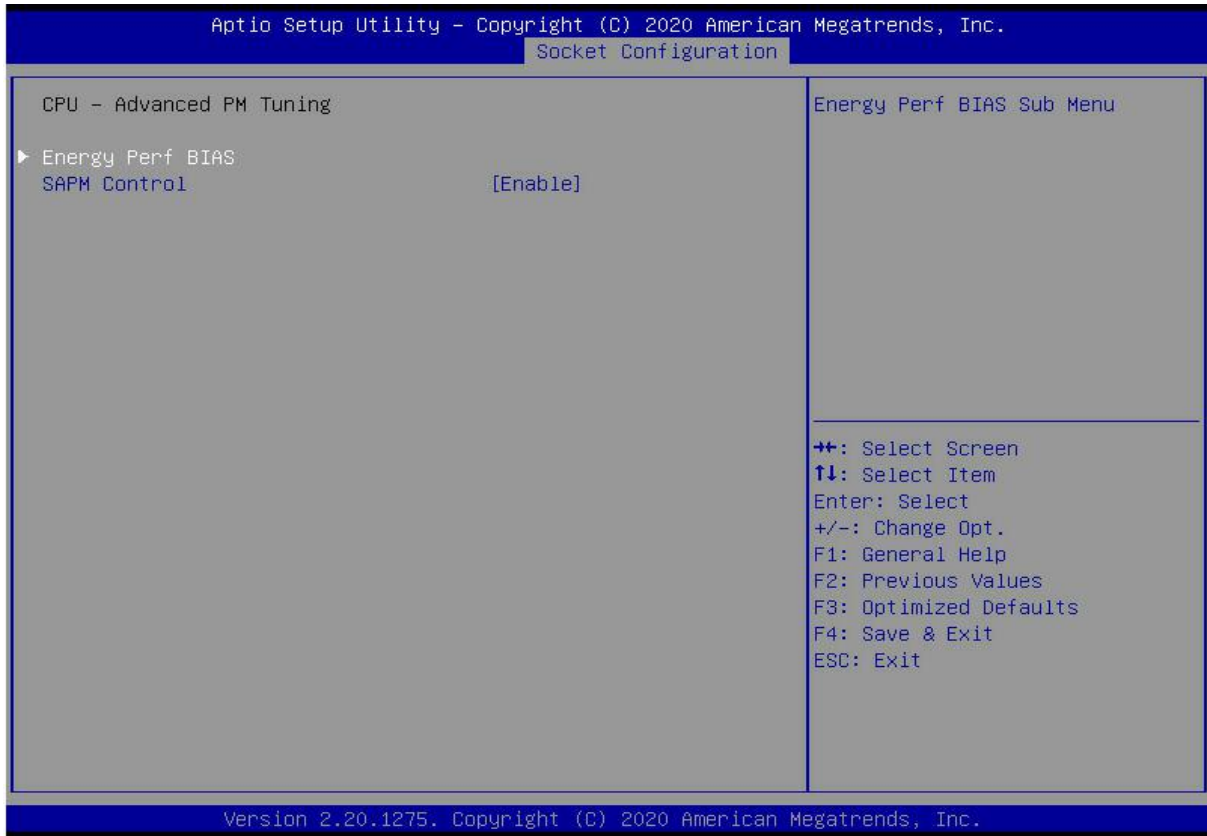

Figure 5- 37

Energy Perf BIAS

CPU energy saving performance related options settings

5.2.37 Energy Perf BIAS

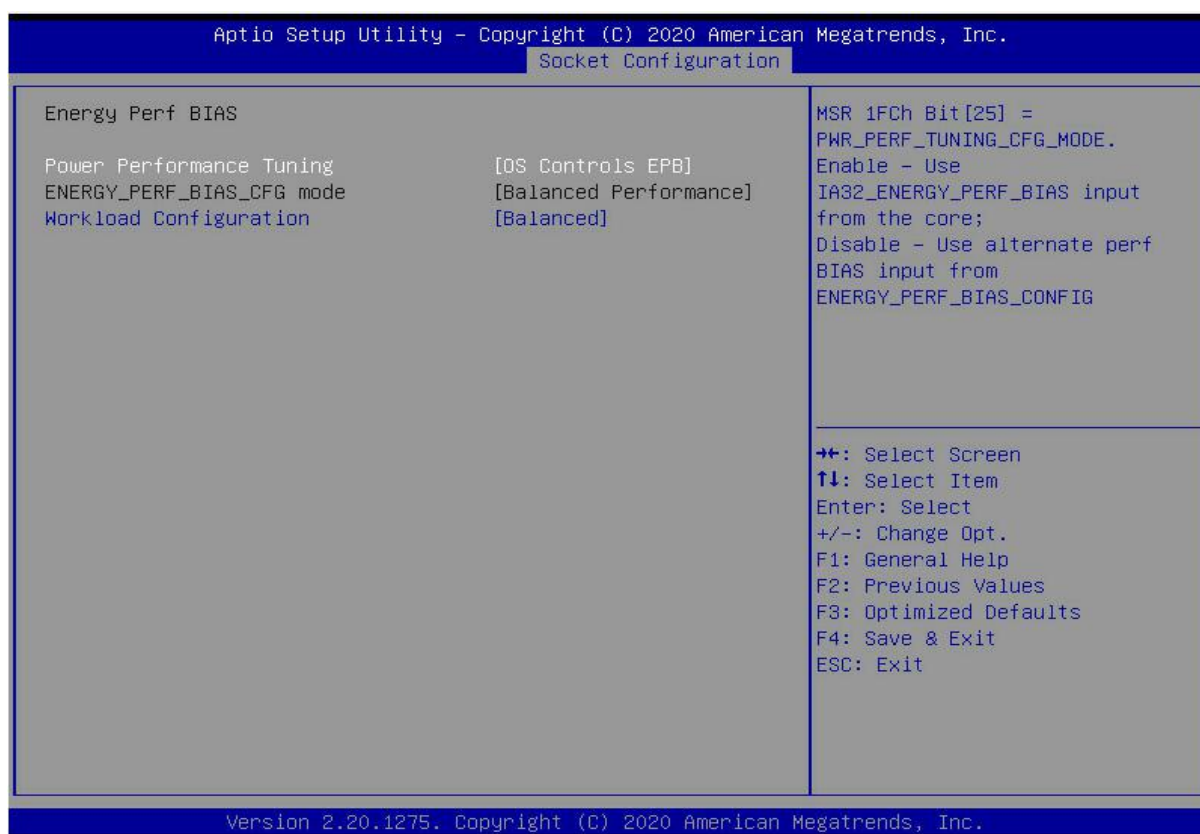

Figure 5- 38

Power Performance Tuning

Energy saving performance adjustment settings, the menu options are:

OS Controls EPB: OS Controls Power Saving Performance Tuning

BIOS Controls EPB: BIOS Controls Power Saving Performance Tuning

Default: OS Controls EPB

ENERGY_PERF_BIAS_CFG Mode

Energy-saving performance management settings, this can be set when Power Performance Tuning is set to BIOS Control EPB, the menu options are:

Performance: performance

Balanced Performance: Balanced Performance

Balanced Power: Balanced Energy Savings

Power: Energy saving

Default: Balanced Performance

Workload Configuration

To optimize settings for workload characteristics, the menu options are:

Balanced

I/O Sensitive

Default: Balanced

5.2.38 Server Mgmt Menu

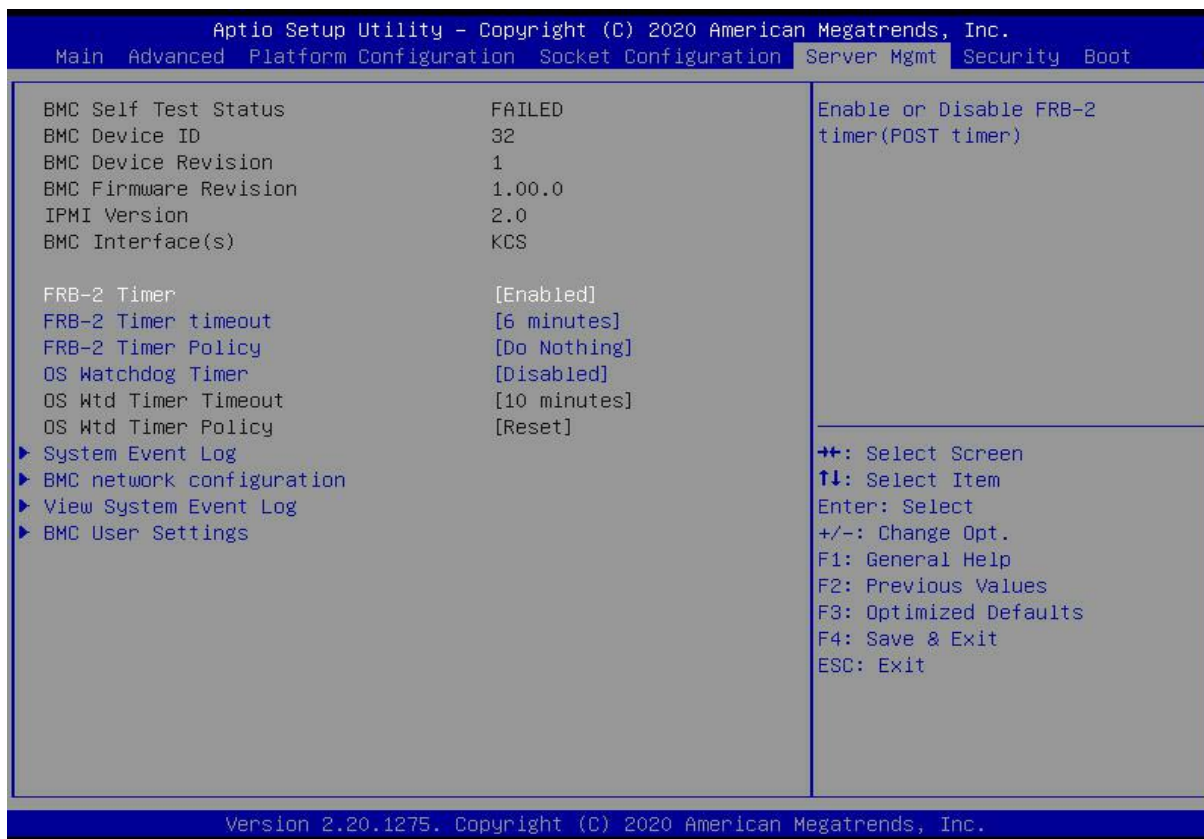

Figure 5- 39

Display BMC self-check status, device ID, device version, BMC software version, and version that supports IPMI specification.

FRB-2 Timer

FRB-2 clock switch settings, the menu options are:

Enabled

Disabled

Default: Enabled

FRB-2 Timer timeout

FRB-2 clock timeout setting, the menu options are:

3 minutes

4 minutes

5 minutes

6 minutes

Default: 6 minutes

FRB-2 Timer Policy

Policy settings after FRB-2 clock timeout, the menu options are:

Do Nothing

Reset

Power Down

Power Cycle

Default: Do Nothing

OS Watchdog Timer

OS watchdog clock switch settings, the menu options are:

Enabled

Disabled

Default: Disabled

OS Wtd Timer timeout

OS watchdog clock timeout setting, the menu options are:

5 minutes

10 minutes

15 minutes

20 minutes

Default: 10 minutes

OS Wtd Timer Policy

The policy setting after the OS watchdog clock times out, the menu options are:

Do Nothing

Reset

Power Down

Power Cycle

Default: Reset

System Event Log menu

System Event Log Control Menu

BMC network configuration menu

BMC Network Configuration Menu

View System Event Log menu

View the System Event Log Control Menu

BMC User Settings menu

BMC User Settings Menu

5.2.39 System Event Log menu

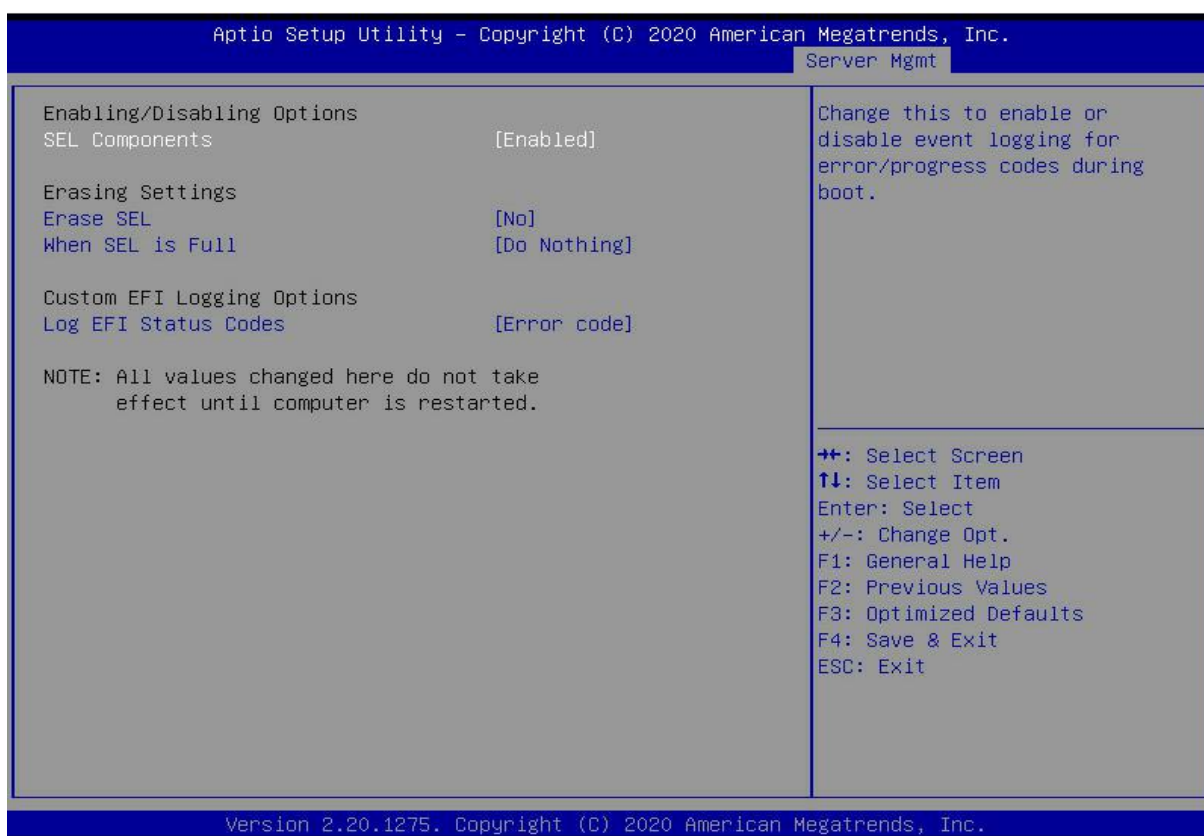

Figure 5- 40

SEL Components

Start-up process system event recording function control switch, menu options:

Enabled

Disabled

Default: Enabled

Erase SEL

Clear system event log control switch, menu options:

No: do not clear

Yes, On next reset

Yes, On every reset

Default: No

When SEL is Full

When the system event record storage space is full, operate the control switch, menu options:

Do Nothing

Erase Immediately

Default: Do Nothing

Log EFI Status Codes

Configuration records EFI Status Codes, menu options:

Disabled: Do not record

Both: Record Error code & Progress code

Error code: Only record Error code

Progress code: Record only Progress code

Default value: Error code

5.2.40 BMC network configuration menu

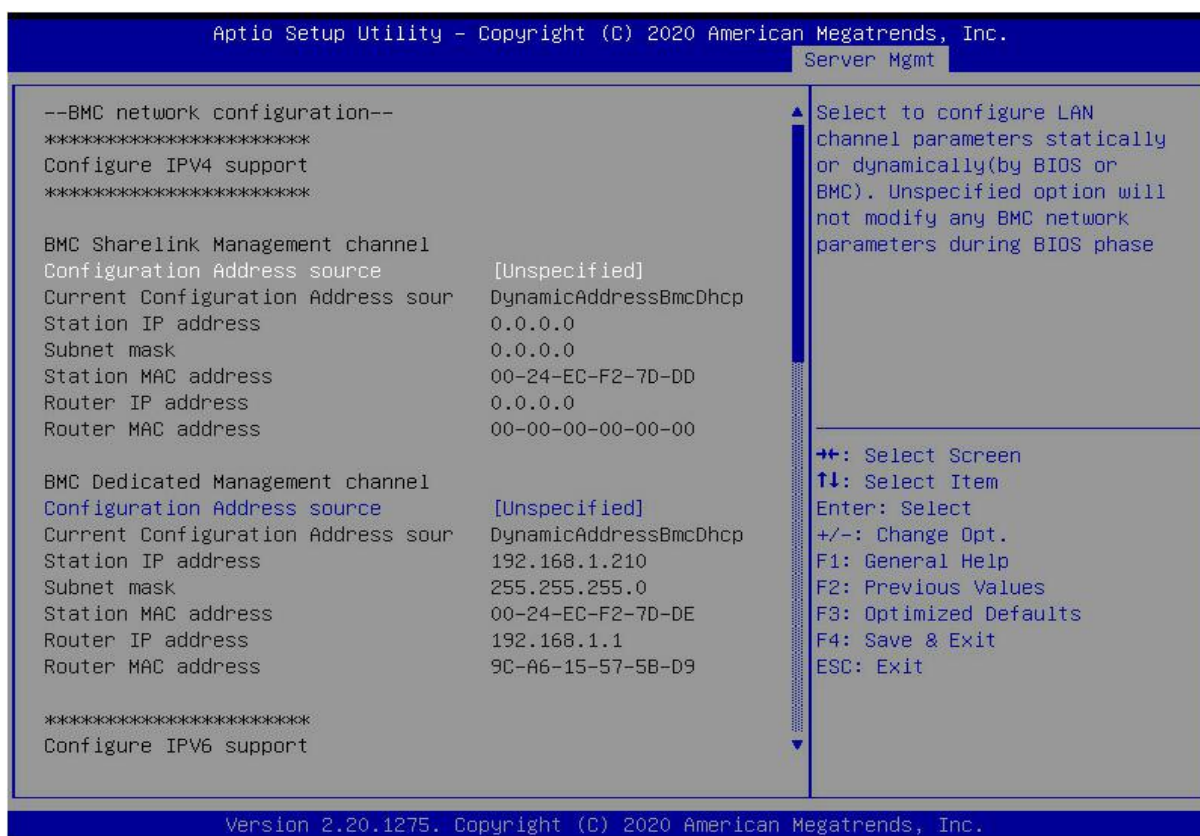

Figure 5- 41

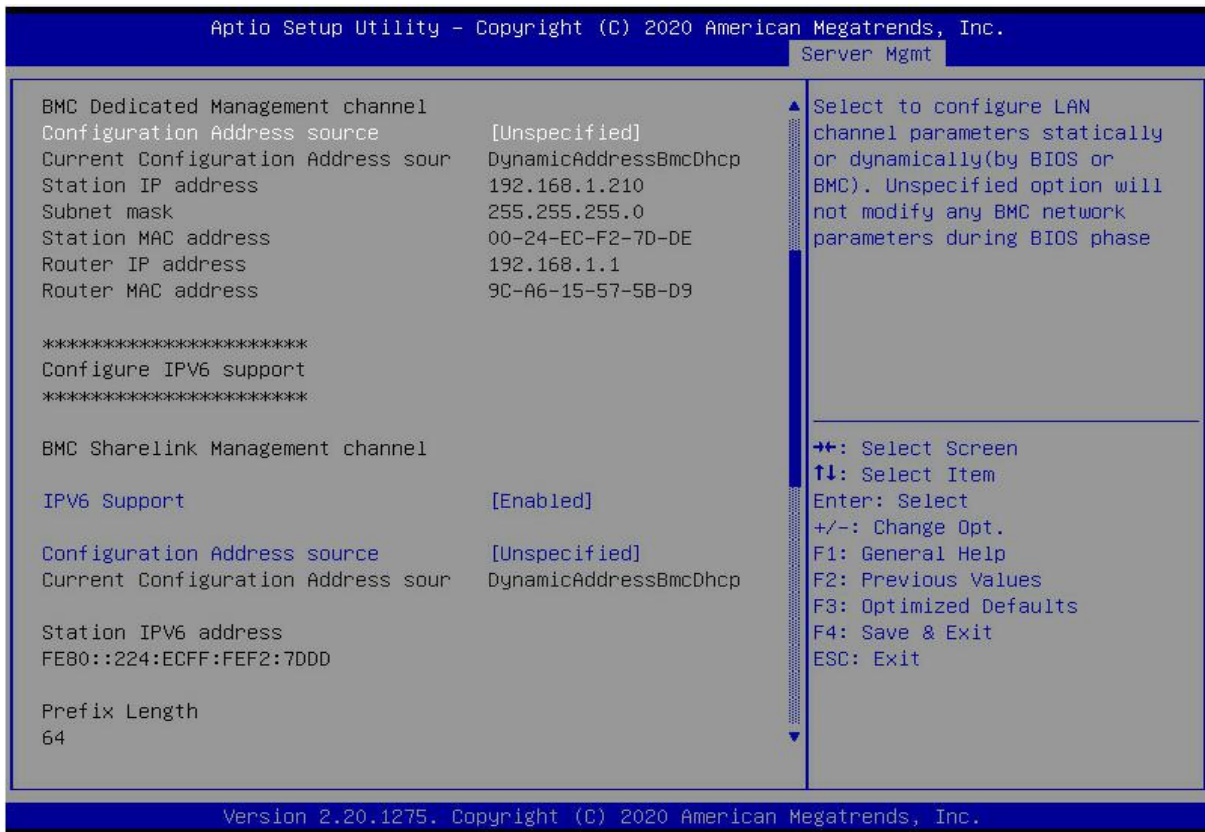

Figure 5- 42

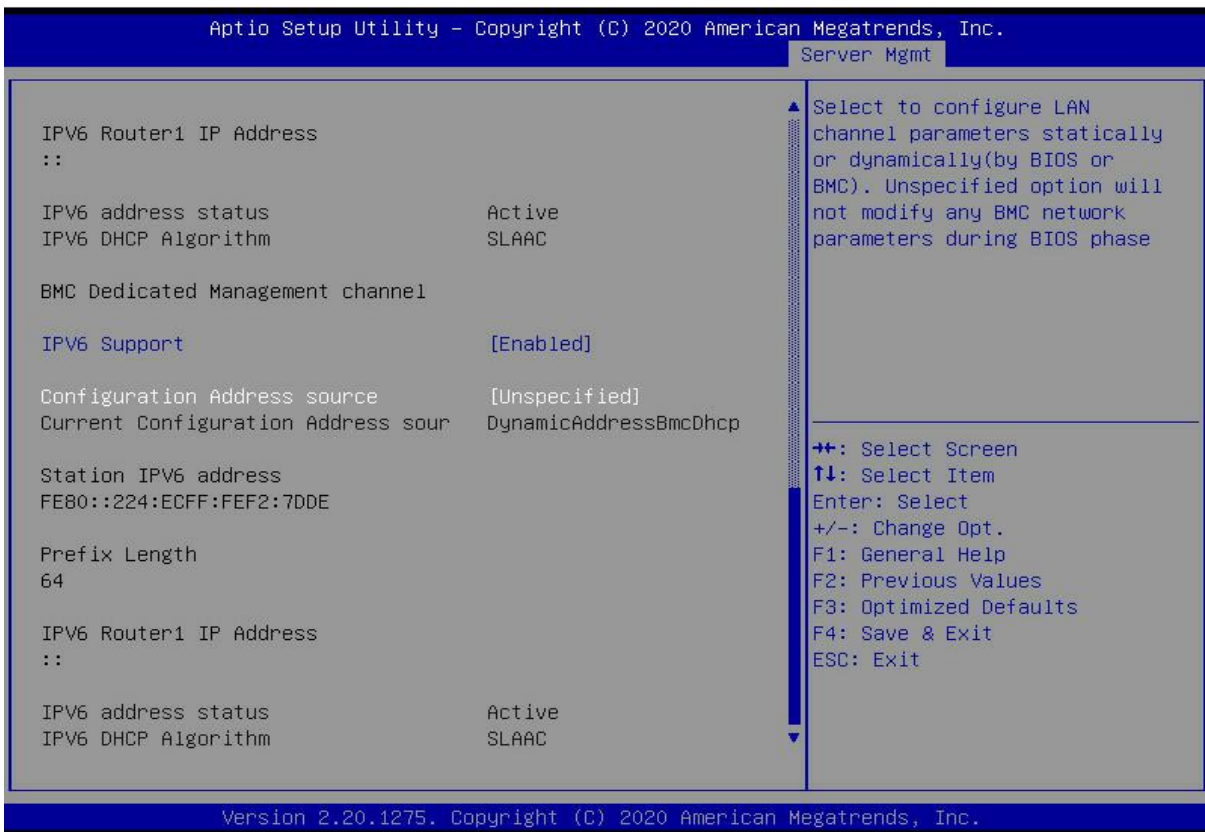

Figure 5- 43

Configure IPv4 support

BMC sharelink Management Channel

Configuration Address source

To configure the BMC IP address allocation mode, the menu options are:

Unspecified: Do not change BMC parameters

Static: BIOS static IP settings

DynamicBmcDhcp: BMC runs DHCP to dynamically assign IP

DynamicBmcNonDhcp: BMC runs Non-DHCP protocol to dynamically assign IP

Default: Unspecified

Modify the parameters from Unspecified to other parameters. After saving and restarting, the options will be restored to the Unspecified value, and there is no need to configure the BMC IP each time the startup process is performed.

When the Configuration Address source option is Unspecified, it will display the network parameter information (IPV4) of the system shared network port, the current IP configuration method, BMC IP, subnet mask, MAC address, routing IP, routing MAC;

BMC Dedicated Management Channel

Configuration Address source

To configure the BMC IP address allocation mode, the menu options are:

Unspecified: Do not change BMC parameters

Static: BIOS static IP settings

DynamicBmcDhcp: BMC runs DHCP to dynamically assign IP

DynamicBmcNonDhcp: BMC runs Non-DHCP protocol to dynamically assign IP

Default: Unspecified

Modify the parameters from Unspecified to other parameters. After saving and restarting, the options will be restored to the Unspecified value, and there is no need to configure the BMC IP each time the startup process is performed.

When the Configuration Address source option is Unspecified, it will display the network parameter information (IPV4) of the dedicated network port of the system, the current IP configuration method, BMC IP, subnet mask, MAC address, routing IP, routing MAC;

Configure IPV6 support

BMC Sharelink Management Channel

IPV6 Support

Choose whether to support IPV6, the menu options are:

Enabled: Supports IPV6

Disabled: Does not support IPV6

Default: Enabled

Modify the parameters from Unspecified to other parameters. After saving and restarting, the options will be restored to the Unspecified value, and there is no need to configure the BMC IP each time the startup process is performed.

When the Configuration Address source option is Unspecified, the network parameter information (IPV6) of the system shared network port will be displayed;

BMC Dedicated Management Channel

IPV6 Support

Choose whether to support IPV6, the menu options are:

Enabled: Supports IPV6

Disabled: Does not support IPV6

Default: Enabled

Modify from Unspecified to other parameters, save and restart the execution, the option will restore the Unspecified value, without the need to configure the BMC IP every time the startup process.

When the Configuration Address source option is Unspecified, the network parameter information (IPV6) of the dedicated network port of the system will be displayed;

5.2.41 View System Event Log menu

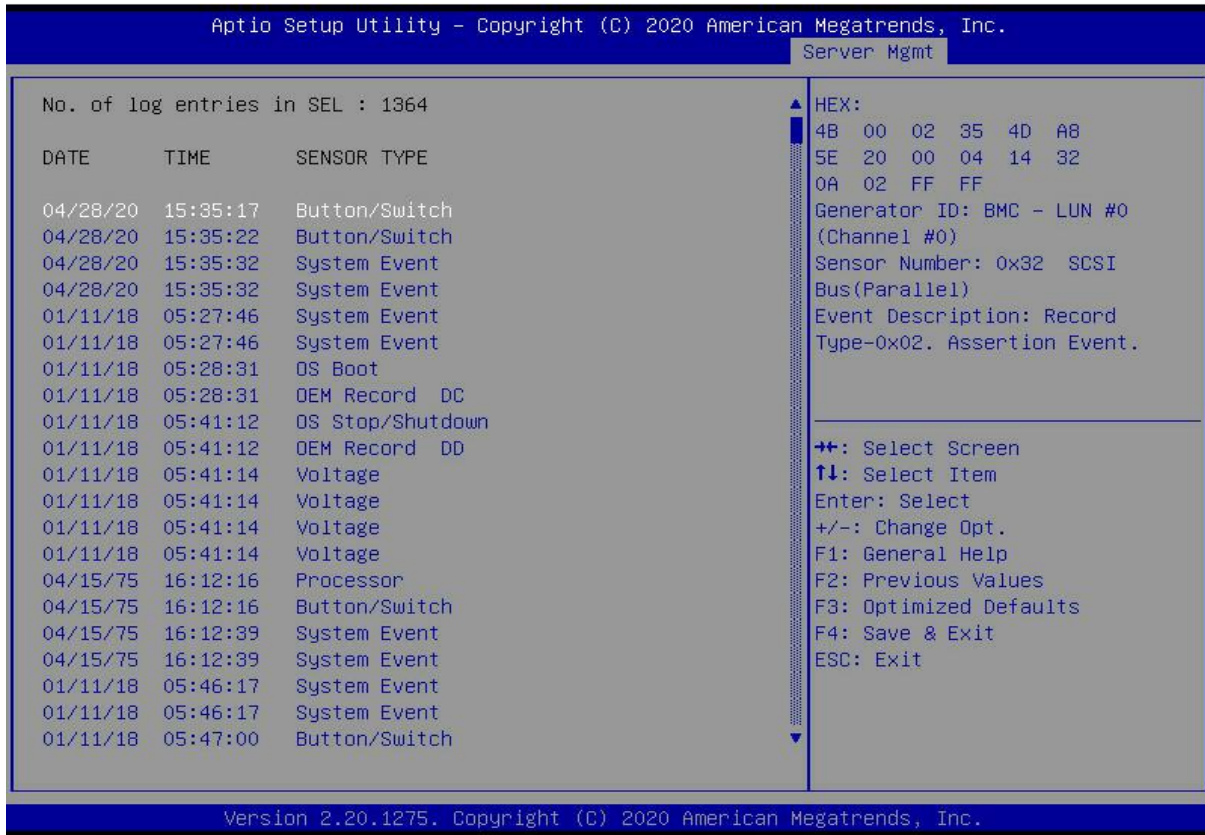

Figure 5- 44

View system event log information.

Note that entering this menu, the BIOS needs to read the SEL data, and it needs to wait for a while.

5.2.42 BMC User Setting

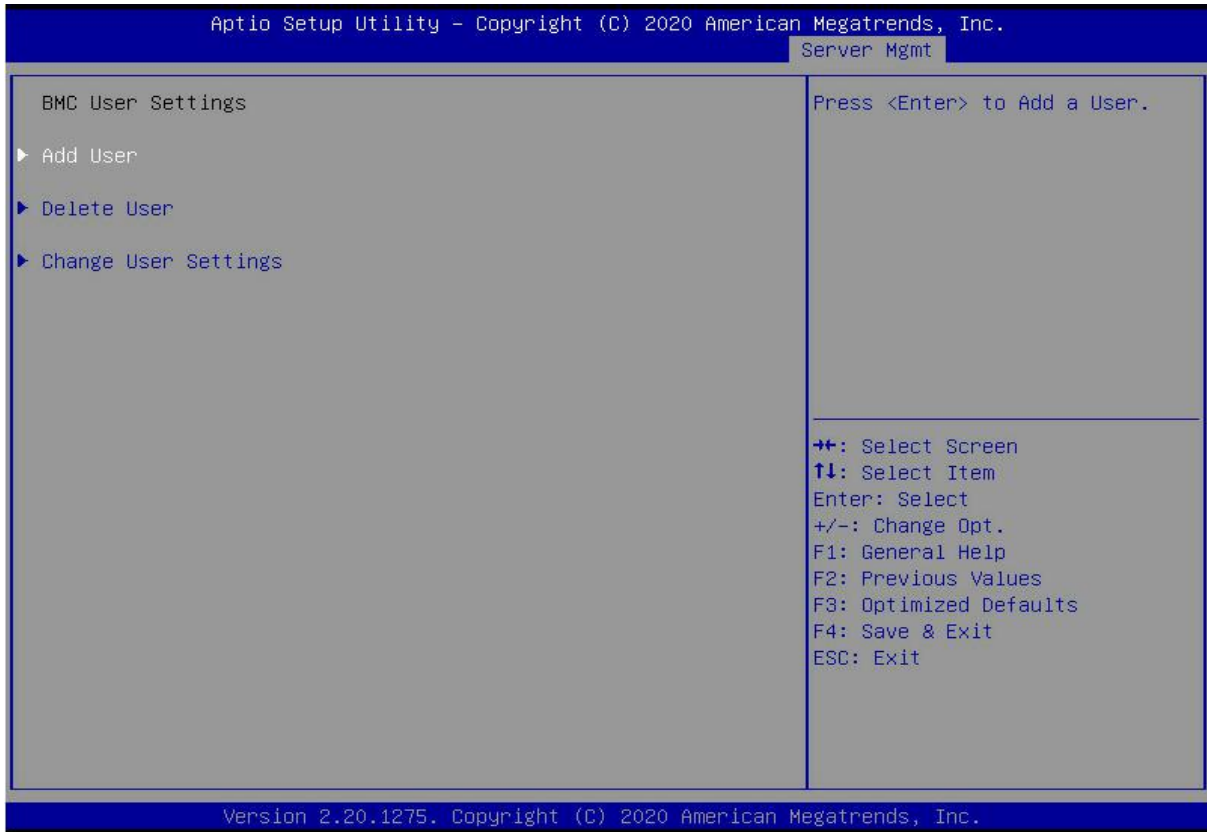

Figure 5- 45

Add User

Delete User

Change User Setting

5.2.43 Add User

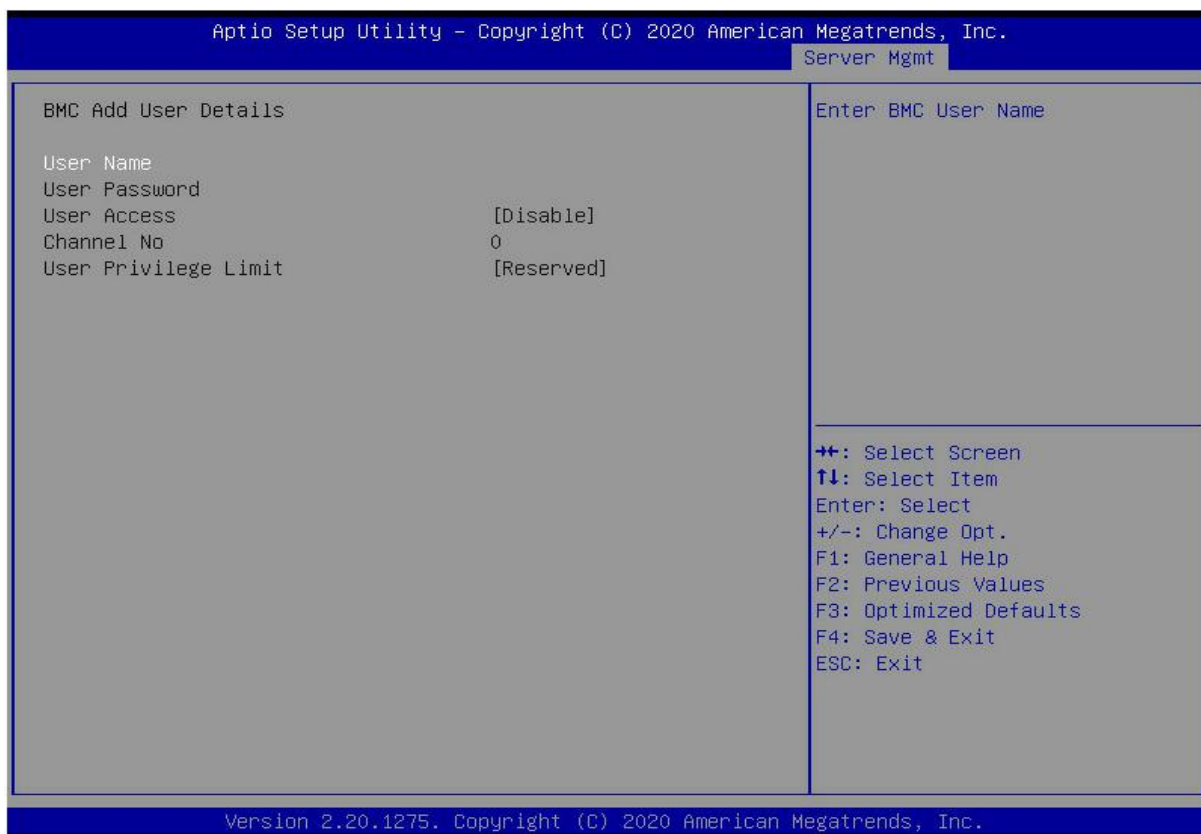

Figure 5- 46

User Name : User name setting, up to 16 characters are supported.

User Password : User password settings, password characters must contain uppercase and lowercase letters, special characters and numbers, with a minimum of 8 characters and a maximum of 20 characters.

Channel No : BMC channel setting, input 1 or 8

User Privilege Limit

User permission settings, menu options are:

Reserved

Callback

User

Operator

Administrator

After the setting is successful, "Set User Access Command Passed" will be prompted, and the BMC User will take effect immediately.

5.2.44 Delete User

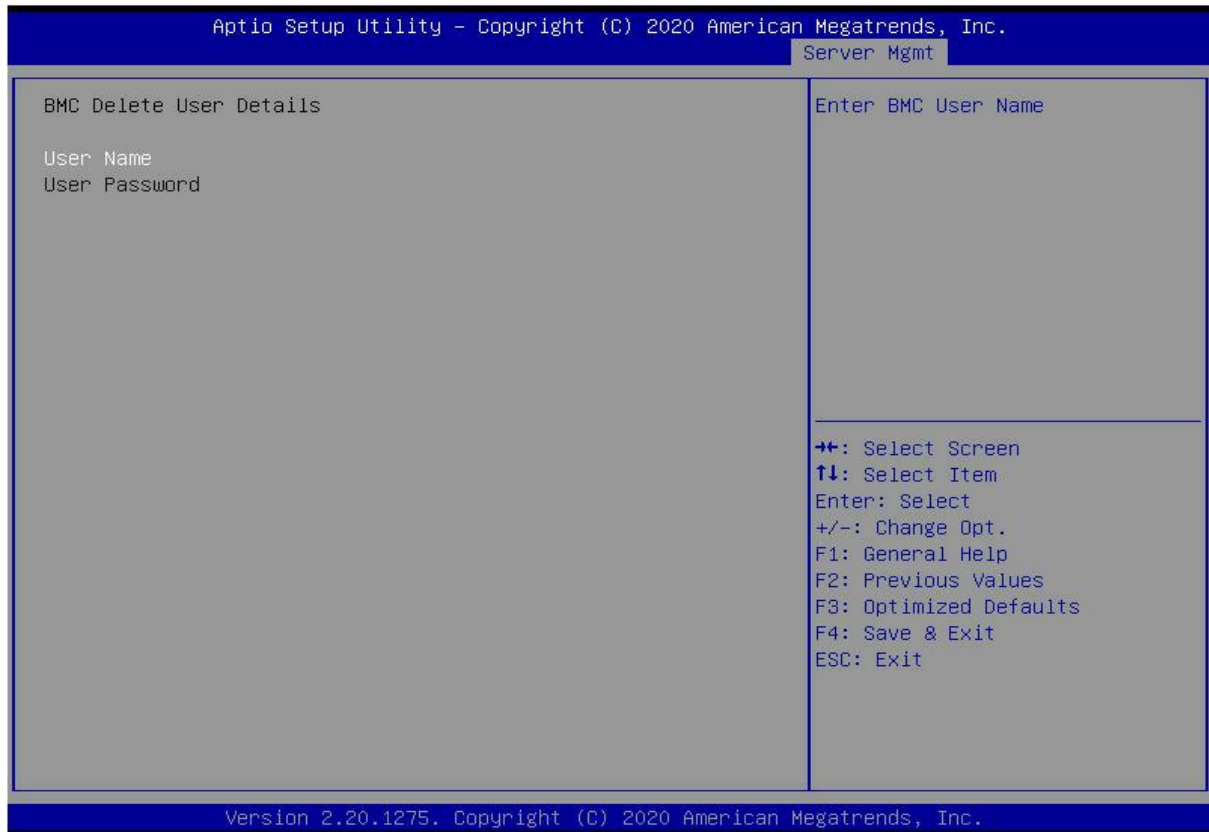

Figure 5- 47

User Name : Enter the user name to delete.

User Password : Enter the password of the user to be deleted. After the correct password is entered, a prompt "User Delete!!!" will pop up. The successfully deleted user will take effect in the BMC immediately, and the user will not be able to log in to the BMC web interface.

5.2.45 Change User Setting

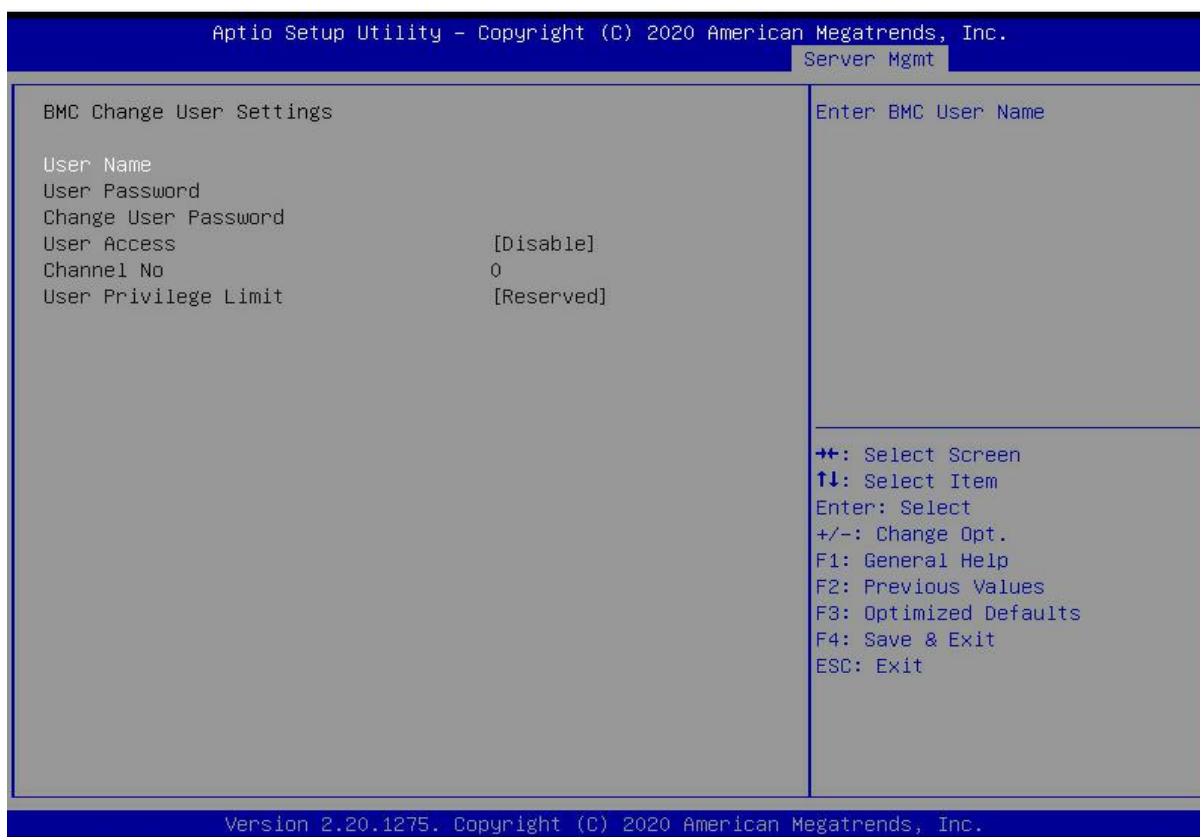

Figure 5- 48

User Name : Enter the user name to be modified.

User Password : Enter to modify the user password, the following options can be modified only if the name and password are entered correctly.

User

User permission switch settings, menu options are:

Enabled

Disabled

Default: Disabled

Change User Password : Change the user password. The input password must contain uppercase and lowercase letters, special characters and numbers, with a minimum of 8 characters and a maximum of 20 characters.

Channel NO : BMC channel setting, input 1 or 8.

User Privilege Limit

To modify user permission settings, the menu options are:

Reserved

Callback

User

Operator

Administrator

5.2.46 Security menu

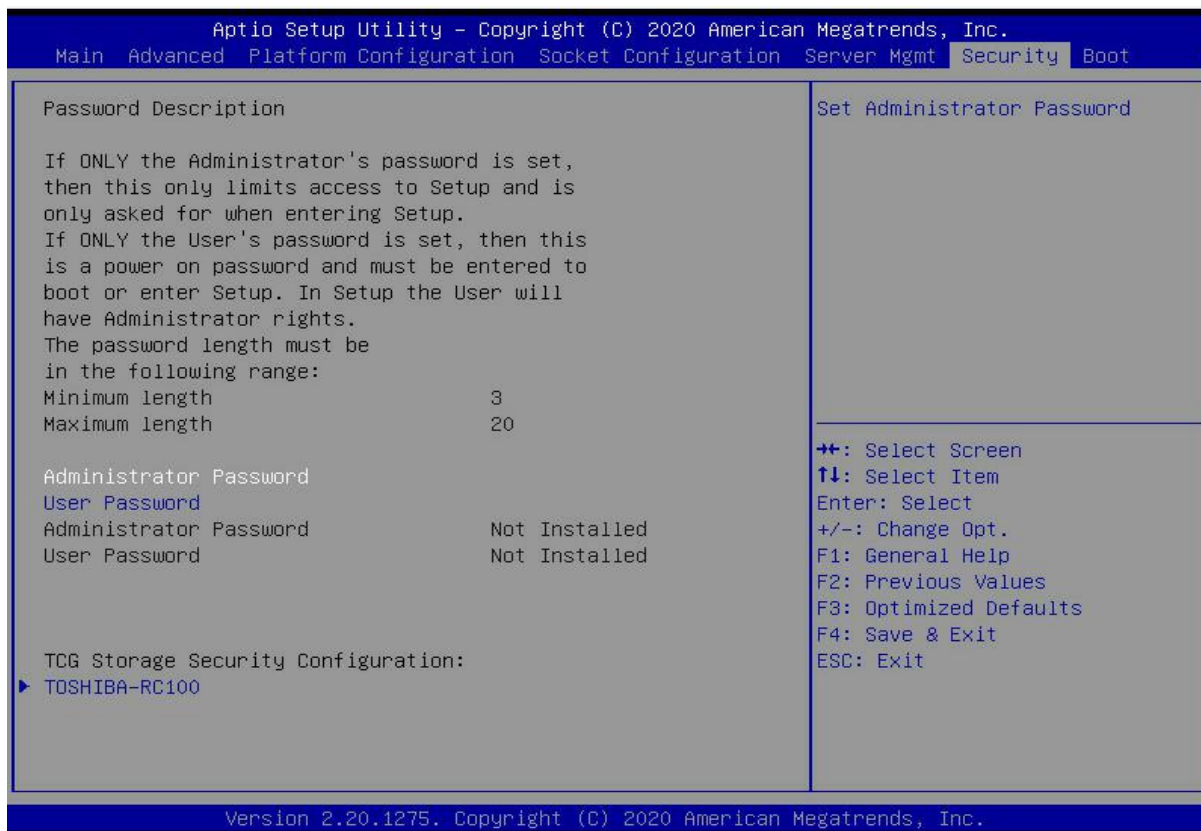

Figure 5- 49

Administrator Password

Selects this option to set an administrator password;

User Password

Selects this option to set user password;

Administrator Password

Displays the administrator password status, if the system has an administrator password, it displays Installed; if there is no administrator password, it displays Not Installed;

User Password

Displays the user password status, if the system has a user password, it displays Installed, if there is no user password, it displays Not Installed;

HDD Security Configuration

The hard disk list is displayed dynamically. The hard disks connected to the SATA and sSATA controllers will be displayed here. Enter the hard disk interface to set the hard disk password. If there is no hard disk connection, it will not be displayed.

5.2.47 Boot menu

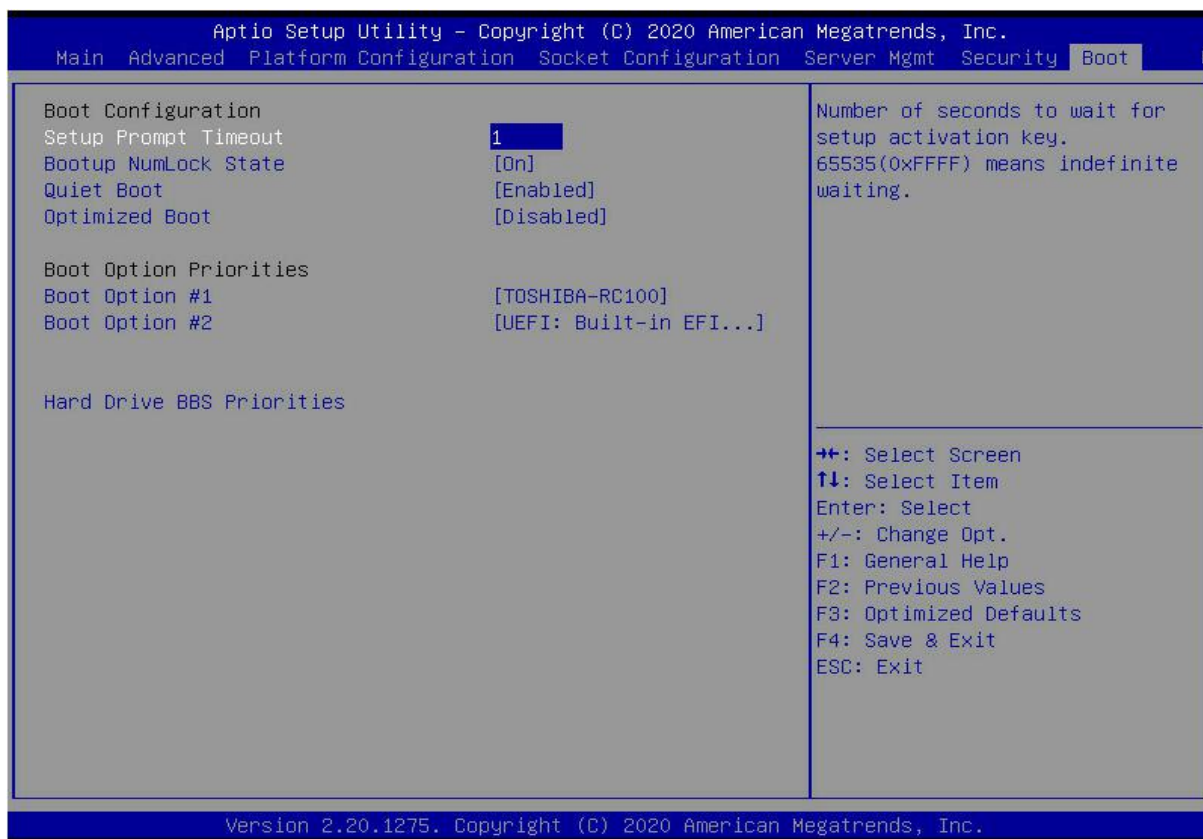

Figure 5- 50

Setup Prompt Timeout: Setup prompt timeout setting, set the time to wait for the Setup activation key, the maximum value is 65535 seconds, and the default value is 1.

Bootup Numlock State

During the boot process, the keyboard Numlock indicator light state switch setting, the menu options are:

On : open

OFF : off

Default: On

Quiet Boot

To turn Quiet Boot on and off, the menu options are:

Disabled: Disable Quiet Boot, and POST information will be displayed at this time

Enabled: Enable Quiet Boot, and the OEM Logo will be displayed at this time

Default: Enabled

Optimized Boot

Turn on and off the Optimized Boot function, the menu options are:

Disabled: Disable Quiet Boot

Enabled: Enable Quiet Boot, which will disable Csm support and connect network devices to reduce startup time

Default: Disabled

Boot Option Priorities

The list of startup options, this list is displayed dynamically and is determined by the number of startup options in the system. When there is no startup item, it will not be displayed.

XXXX Driver BBS Priorities

XXXX device BBS priority setting

5.2.48 Save & Exit menu

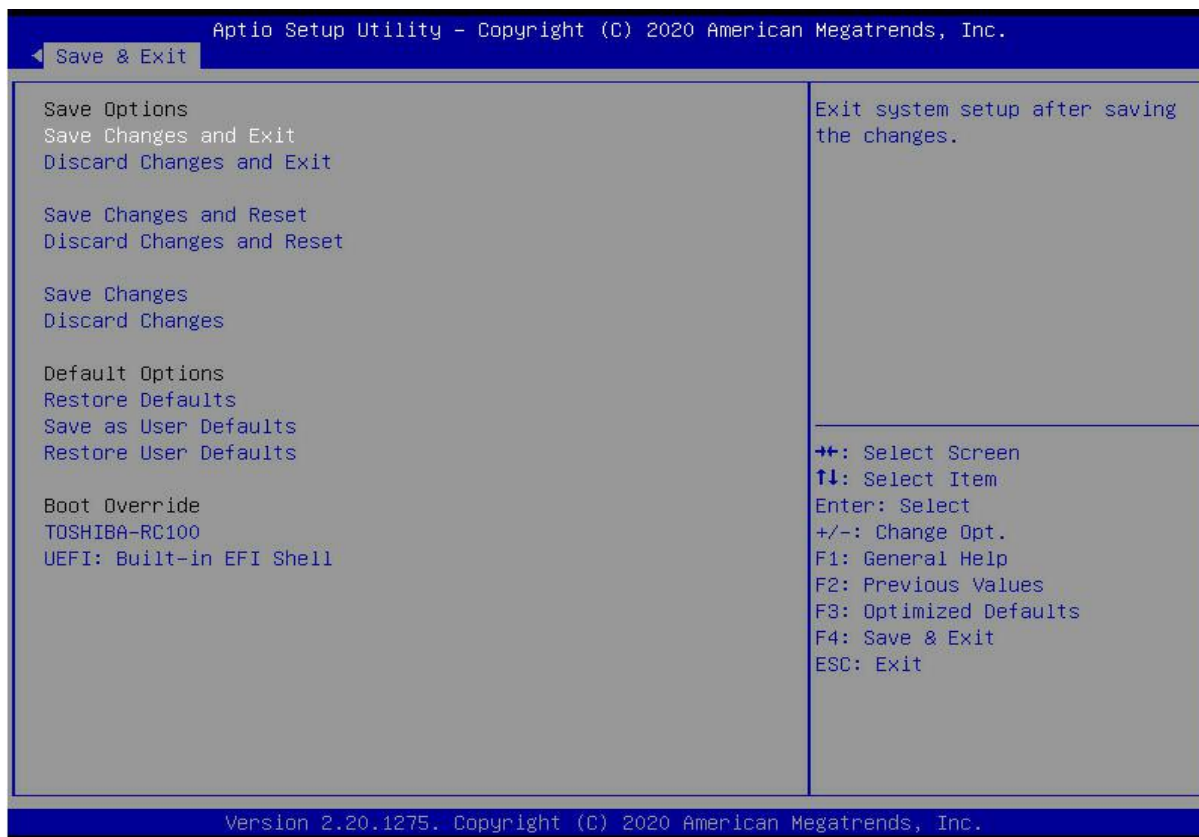

Figure 5- 51

Save Changes and Exit

Save the settings and exit the BIOS setup menu;

Discard Changes and Exit

Abandon saving settings and exit BIOS setup menu;

Save Changes and Reset

Save the settings and restart the system;

Discard Changes and Reset

Give up saving the settings and restart the system;

Save Changes

Discard Changes

Restore Defaults

Save as user Defaults

Restore user Defaults

Boot Override

A list of startup options, where a startup option can be selected.

5.3 User Operation Reminder

1. When the user operates, understand the operating specifications in detail.

2. When operating options, please understand the meaning of the options in combination with the operation manual and the BIOS Setup interface option descriptions.

Chapter 6 RAID Setup Instructions

6.1 PCH group RAID

6.1.1 Configuring RAID in UEFI Boot Mode

6.1.2 Group raid operation

During the server startup process, press Delete/Esc as prompted to enter the BIOS Setup interface. Move to the PlatForm page-->PCH Configuration-->PCH Sata Configuration-->Configure SATA as. Configure SATA to RAID mode, as shown in Figure 6-1.

Figure 6-1 Configure SATA to RAID mode:

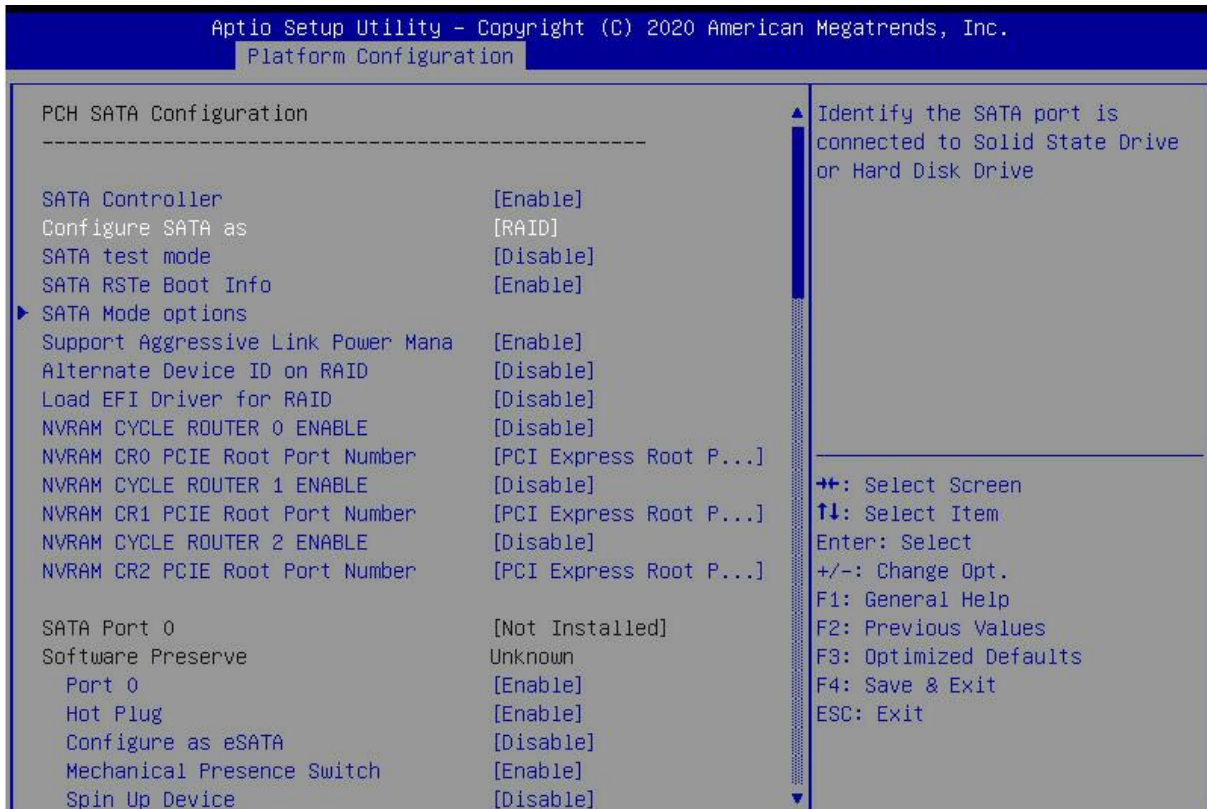

Figure 6- 1

Make sure that Storage and Video in CSM Configuration are in UEFI mode, as shown in Figure 6-2, set Storage and Video to UEFI mode

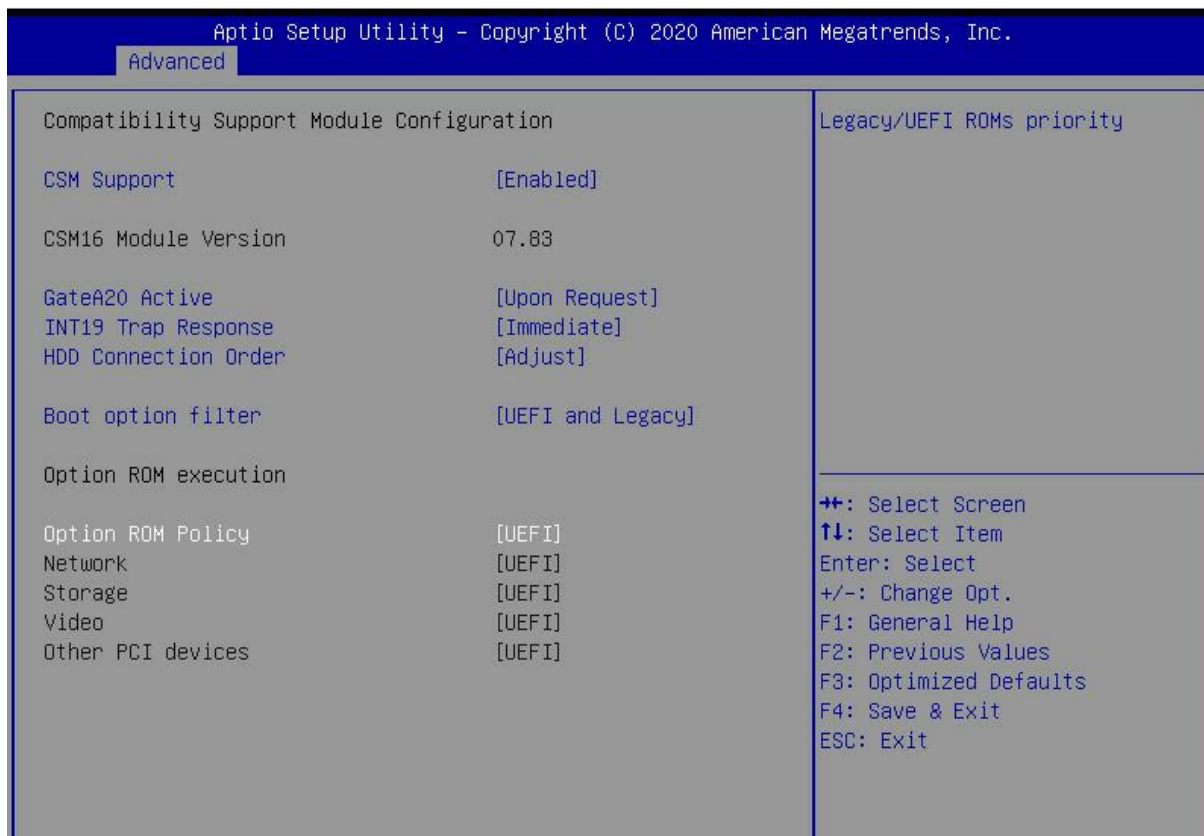

Figure 6-2

Restart the server to enter the BIOS Setup interface, move to the Advanced page, you will see the intel(R) RSTe SATA Controller, press enter to enter the RAID configuration, as shown in Figure 6-3

Figure 6-3 Intel RSTe SATA Controller

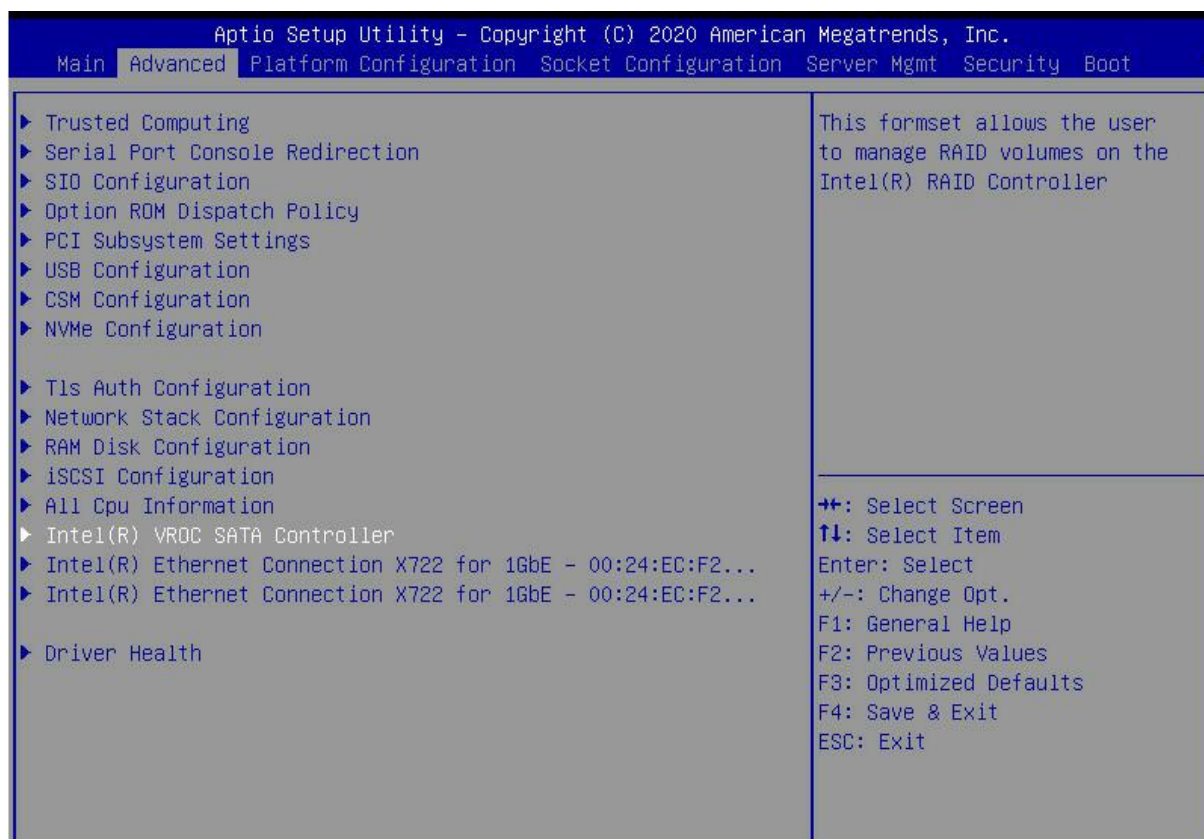

Figure 6-3

Create RAID

Select Create RAID Volume and press enter. Figure 6-4

Figure 6-4 Create RAID

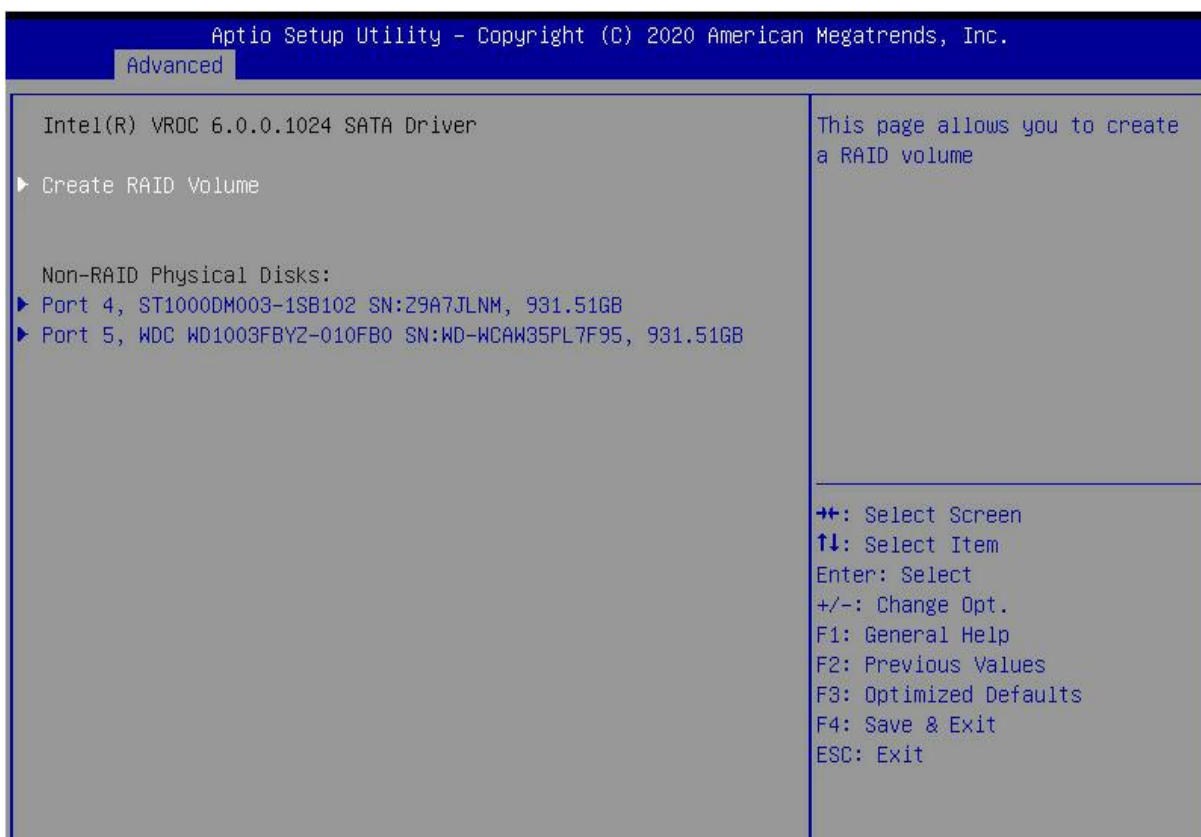

Figure 6- 4

Change the name of the created raid, being careful not to contain special characters. Figure 6-5

Figure 6-5 Create RAID name

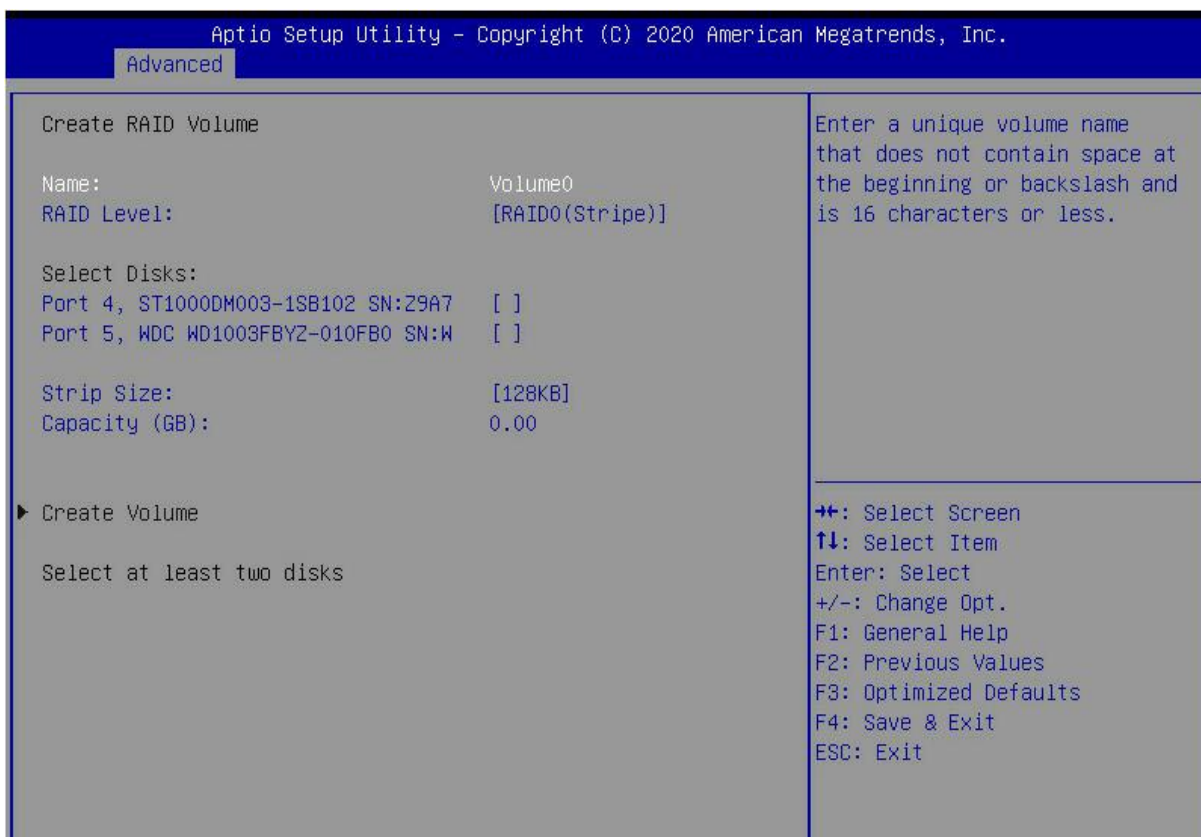

Figure 6- 5

RAID Level: Select the RAID level of the group, as shown in Figure 6-6, select the RAID level of the group

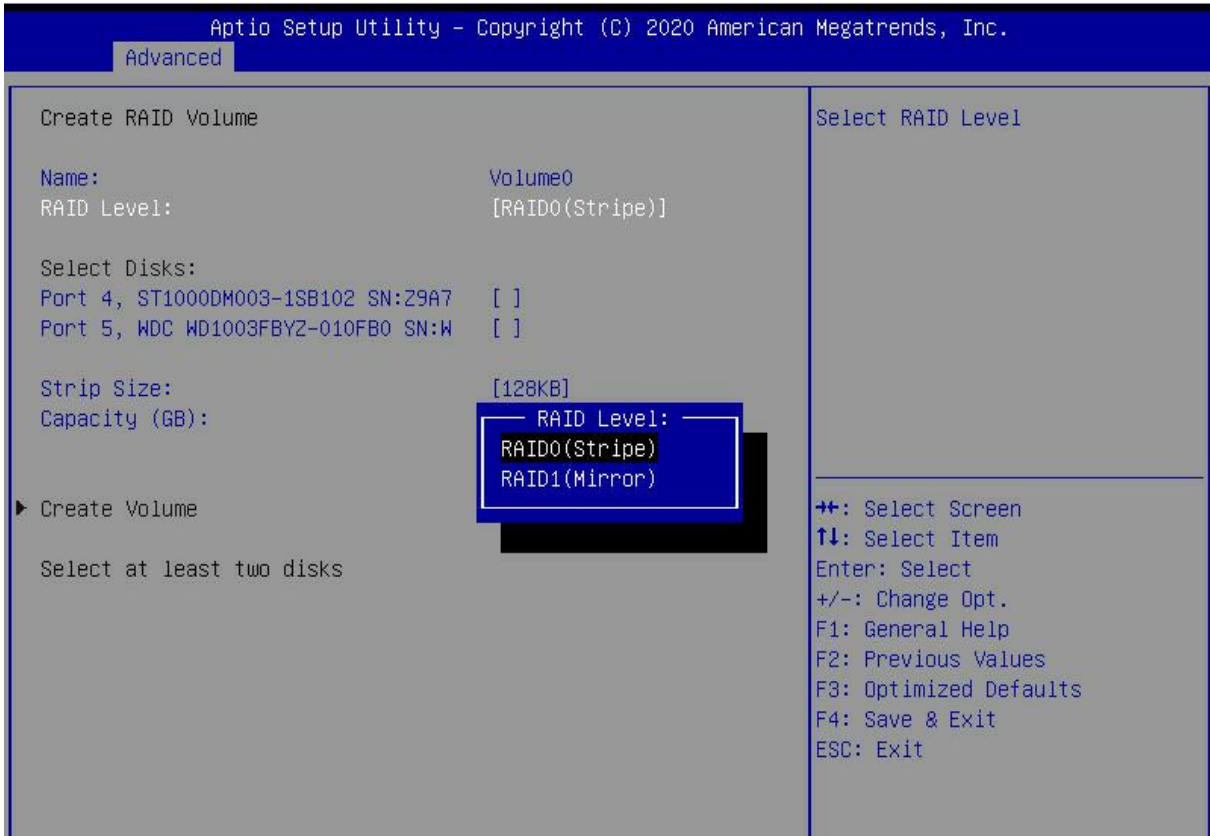

Figure 6- 6

Select Disks: Press the space bar to select the disks that need to participate in the group RAID. Figure 6-7
Figure 6-7 Selecting disks for group RAID

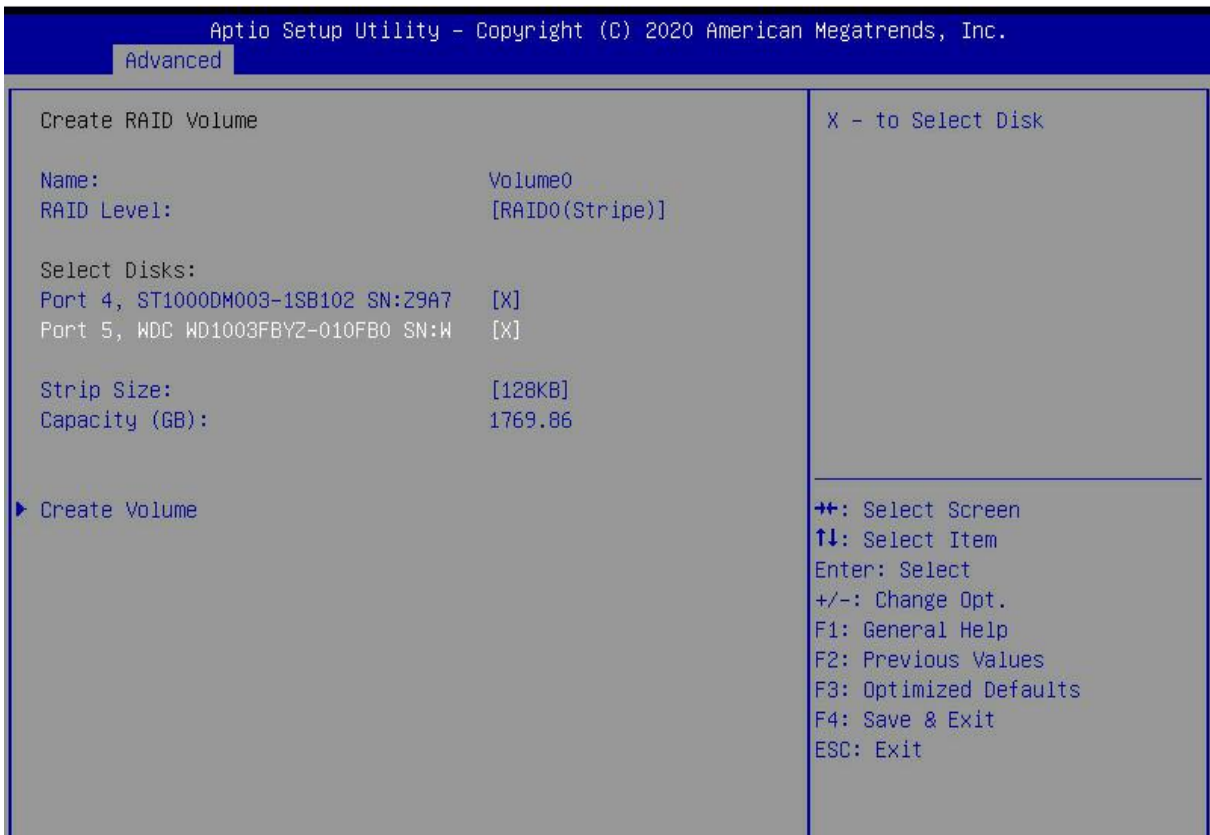

Figure 6- 7

Select Create Volume and press Enter to group the raid.

The relevant parameters are described in Table 1-36:

Parameter	Description
Name	The name of the RAID.
RAID Level	RAID levels, which determine logical disk performance, fault tolerance, and capacity.
Select Disks	Select the member disks that make up the RAID. The available disks are displayed below the Select Disks column. Press Enter to select the disk. [X] indicates that the disk has been selected.
Strip Size	Stripe size, the size of the stripe data blocks written on each disk.
Capacity	The capacity of the logical disk.

Table 1- 36

After the RAID is created, it will be displayed under the RAID Volumes directory. Select a RAID and press Enter to view the detailed information of the RAID (including RAID name, level, and disk information, etc.).

Configure Hot Spare Disk

As shown in Figure 6-8, select the disk to be configured as a hot spare, and press Enter.

Figure 6-8 Selecting a disk to configure as a hot spare

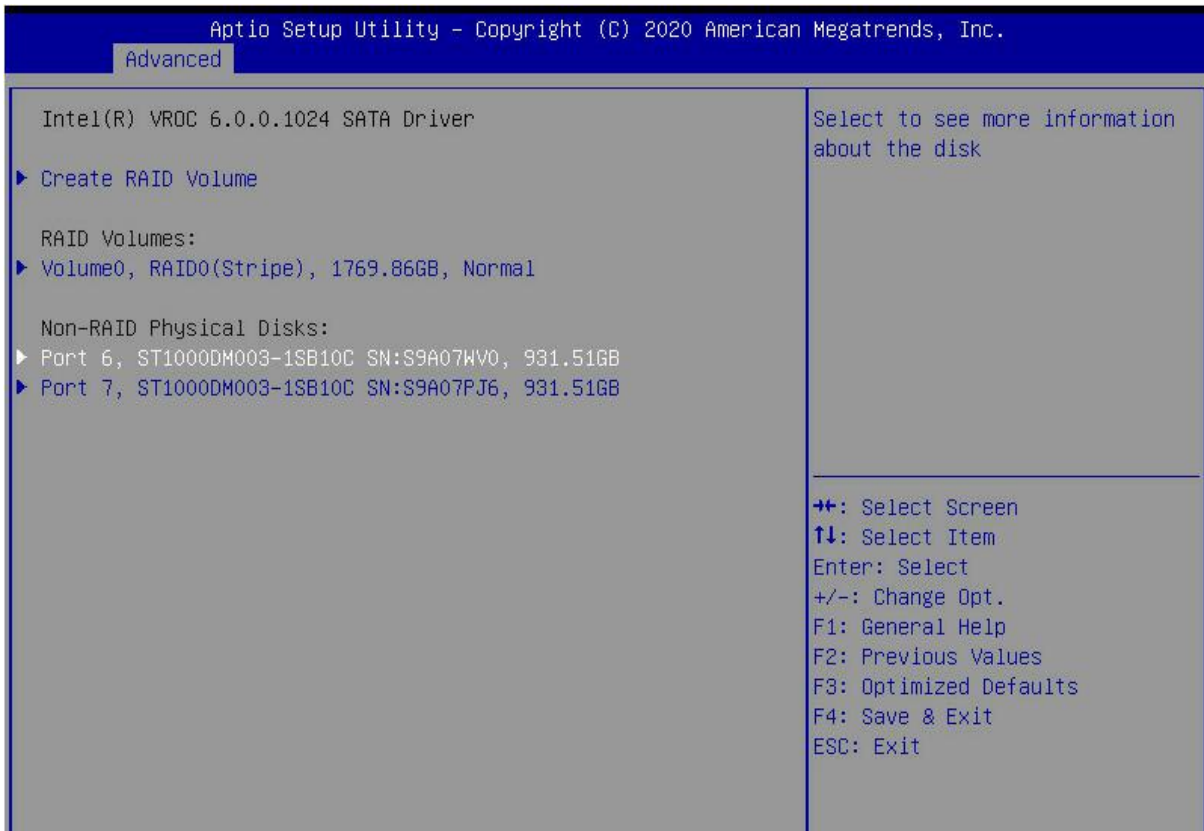

Figure 6-8

Enter the interface shown in Figure 6-9, select "Mark as Spare", and press Enter.

Figure 6-9 Hot spare disk configuration interface

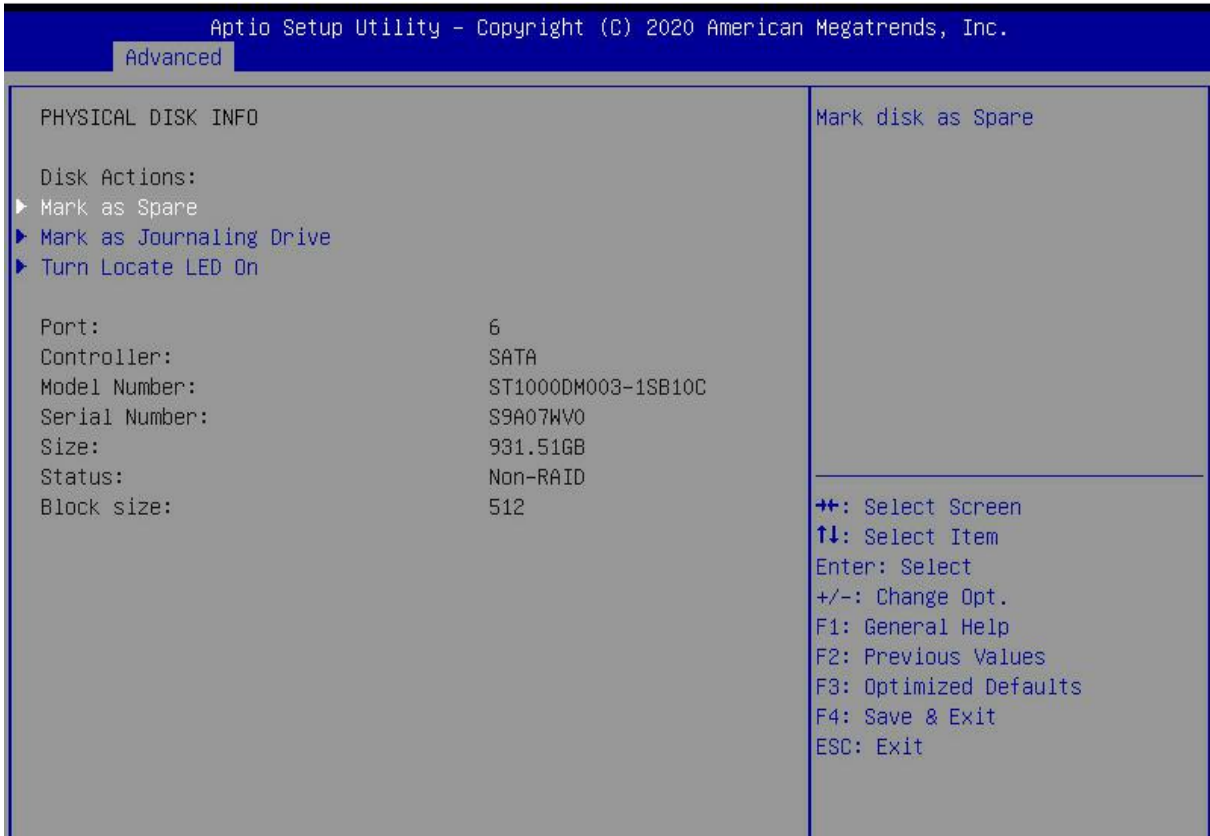

Figure 6-9

The interface shown in Figure 6-10 is displayed, select Yes, and press Enter to complete the configuration of the hot spare disk.

Figure 6-10 Confirming the configuration of the hot spare disk

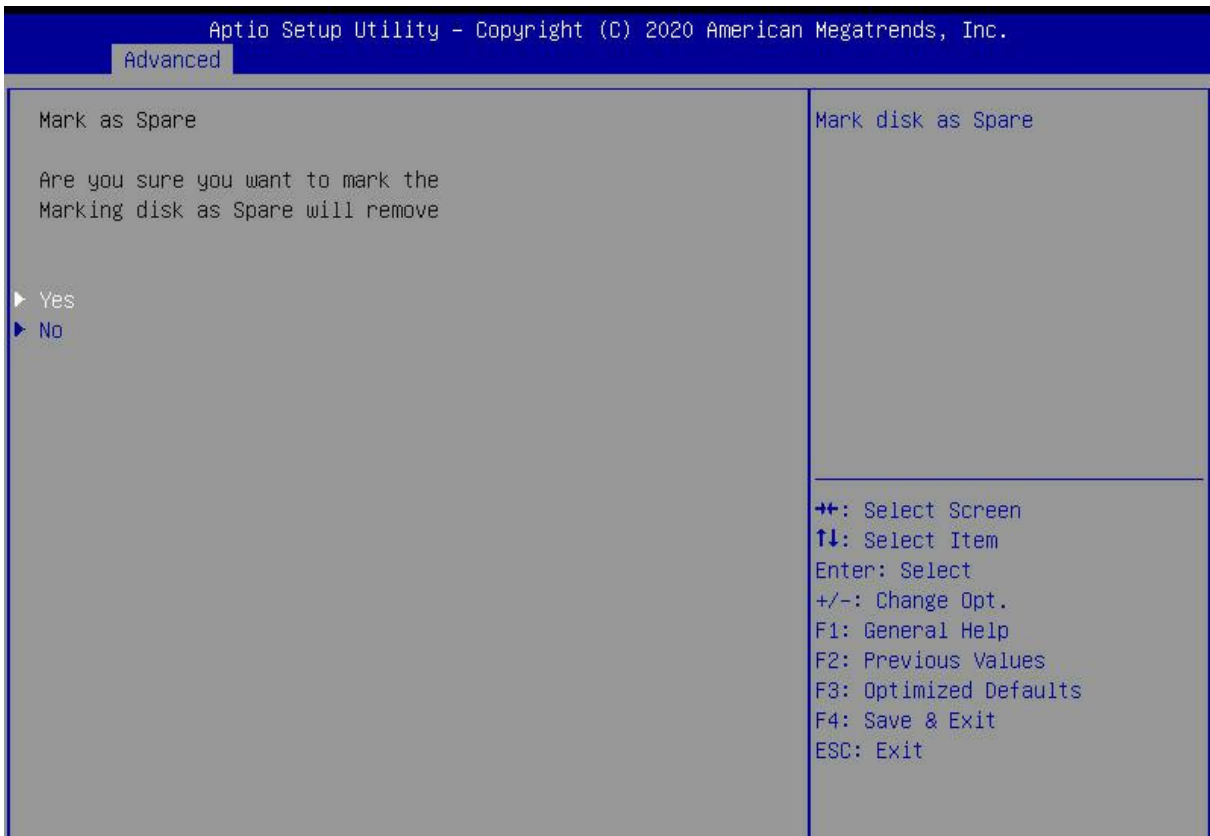

Figure 6-10

Delete RAID

Enter the RSTe configuration interface.

As shown in Figure 6-11, select the RAID to be deleted in the RAID Volumes directory, and press Enter.

Figure 6-11 Selecting the RAID to be deleted

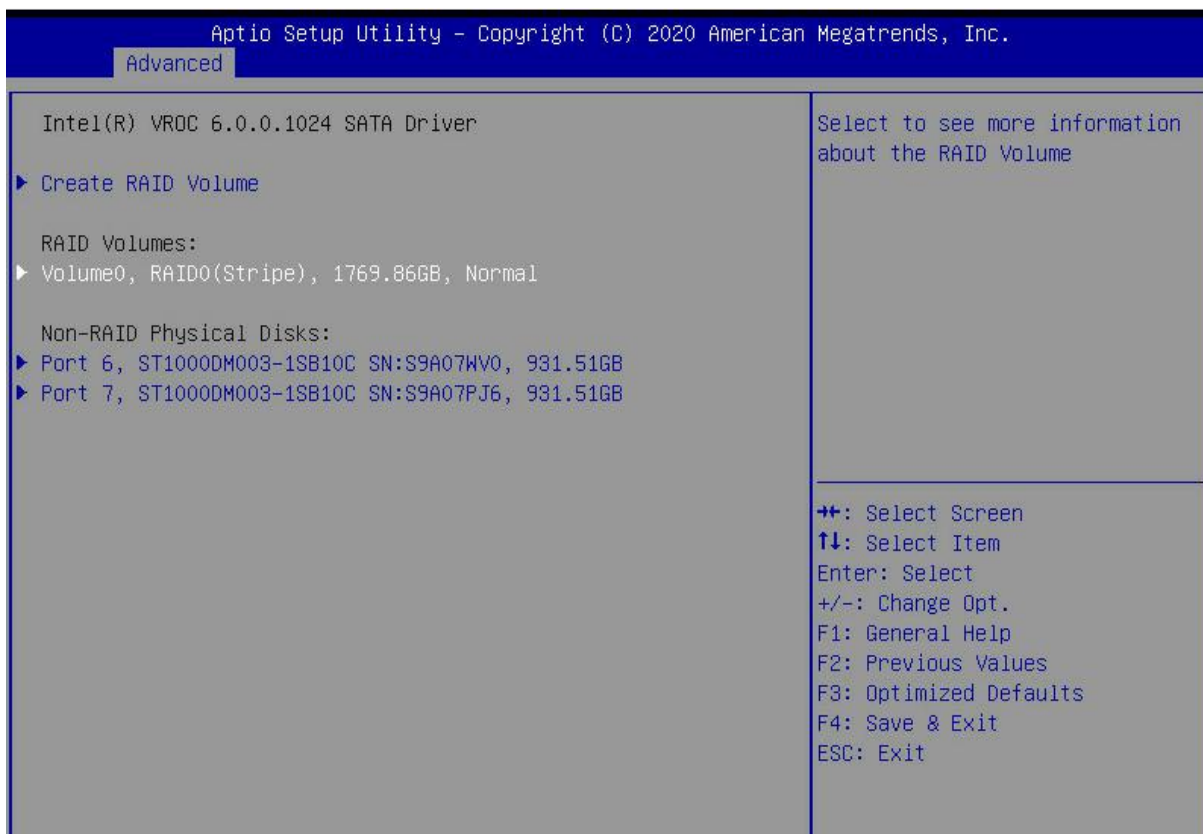

Figure 6- 11

Enter the RAID information interface shown in Figure 6-12, select Delete, and press Enter to delete the RAID. Figure 6-12 RAID information interface

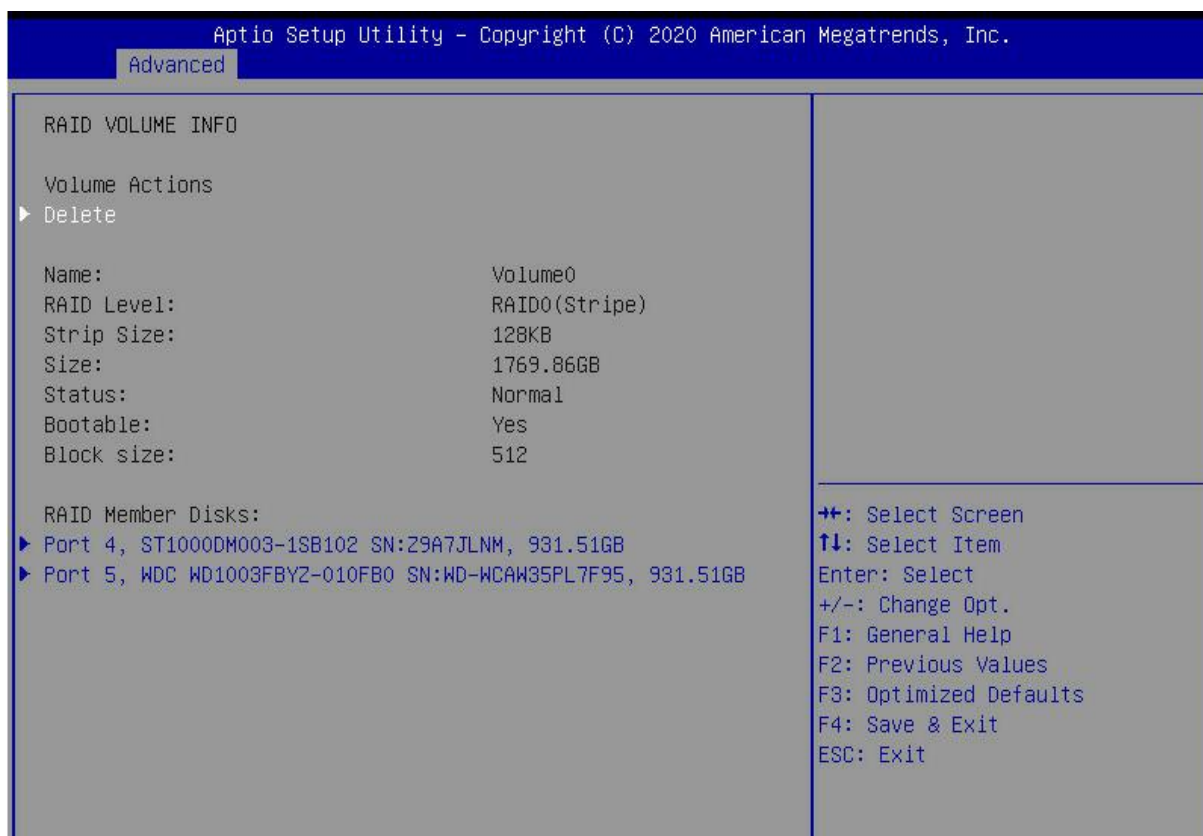

Figure 6- 12

6.1.3 Configuring RAID in Legacy Boot Mode

Set RSTe working mode

Enter the BIOS Setup interface.

Move to the PlatForm page-->PCH Configuration-->PCH SATA Configuration

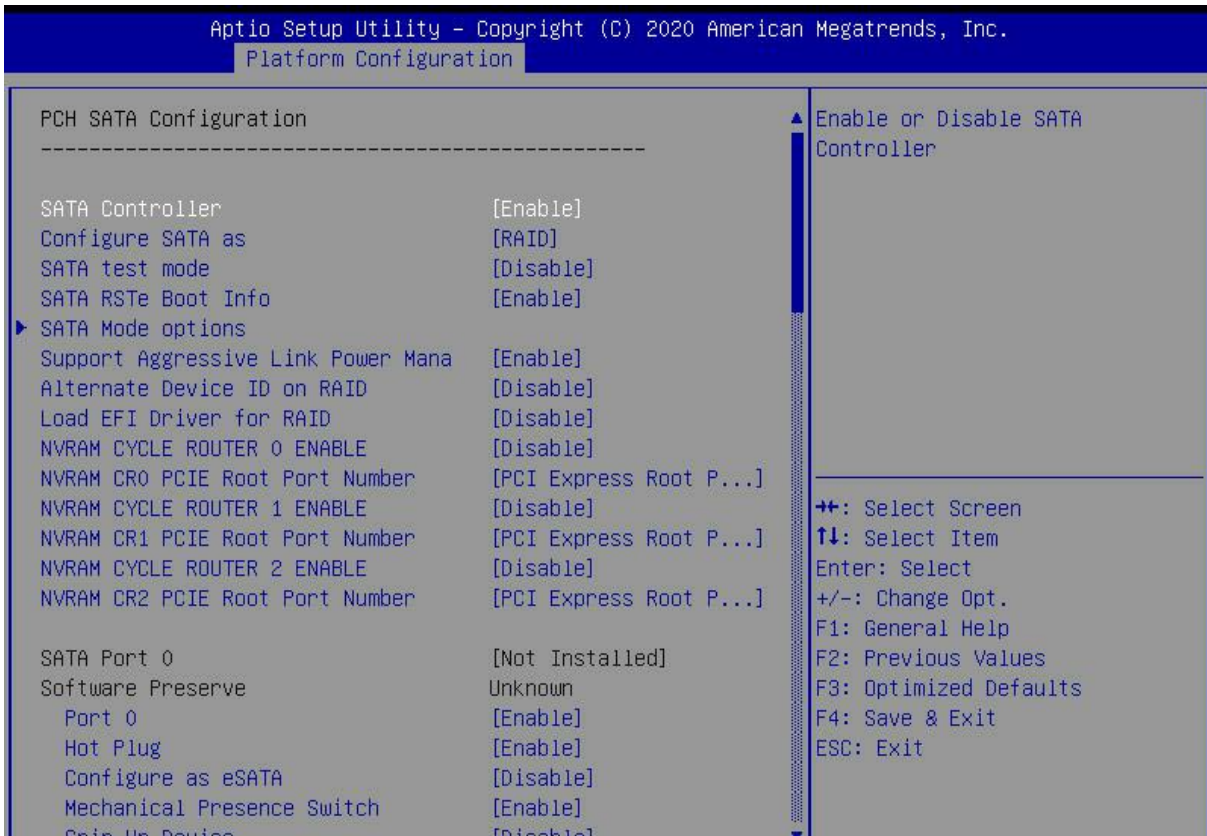

Figure 6- 13

The onboard soft RAID of RSTe has two controllers, SATA and sSATA, which manage the disks connected to the two interfaces of the RAID card respectively. The SATA controller supports up to 8 disks, and the sSATA controller supports up to 6 disks.

Enter the interface shown in Figure 6-14, select the Configure SATA As item, press Enter, and select the working mode of the RSTe onboard soft RAID.

Figure 6-14 Modifying the working mode of the RAID card

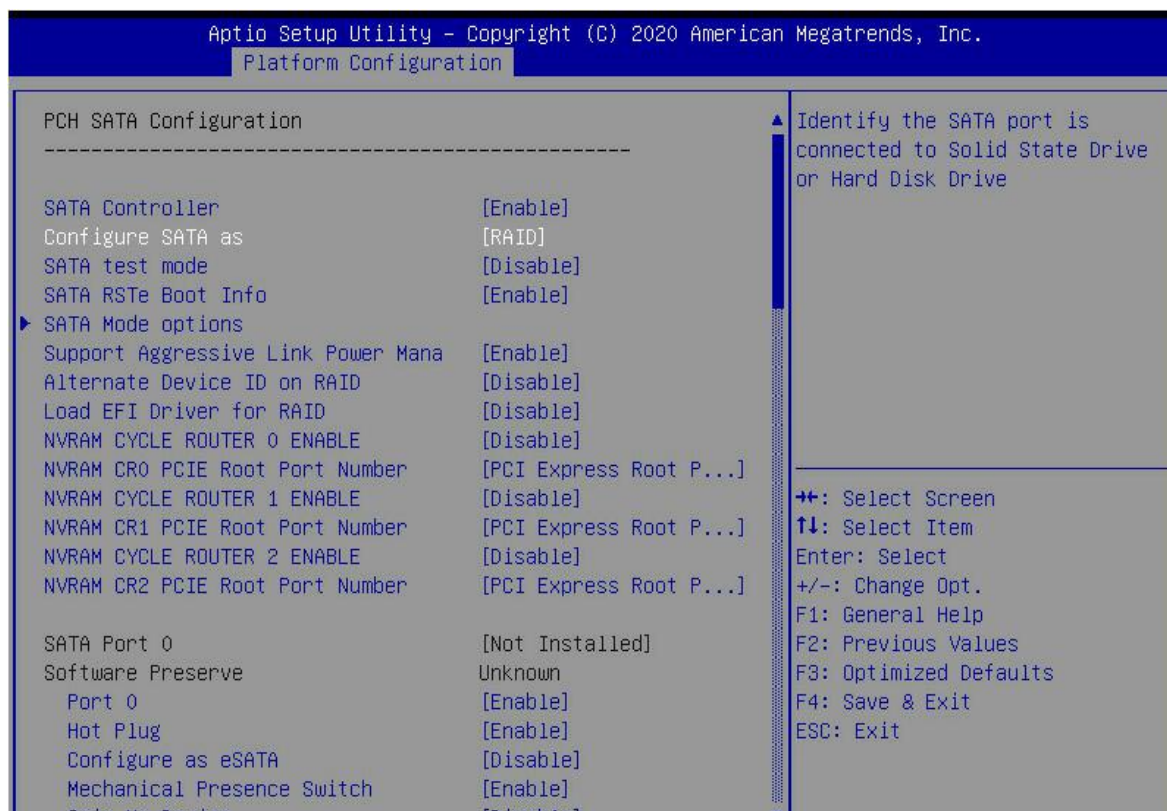

Figure 6- 14

Enter the RSTe configuration interface

Power on or restart the server, and press Ctrl+I when the interface shown in Figure 6-15 is displayed during the BIOS startup process.

Figure 6-15 BIOS startup interface

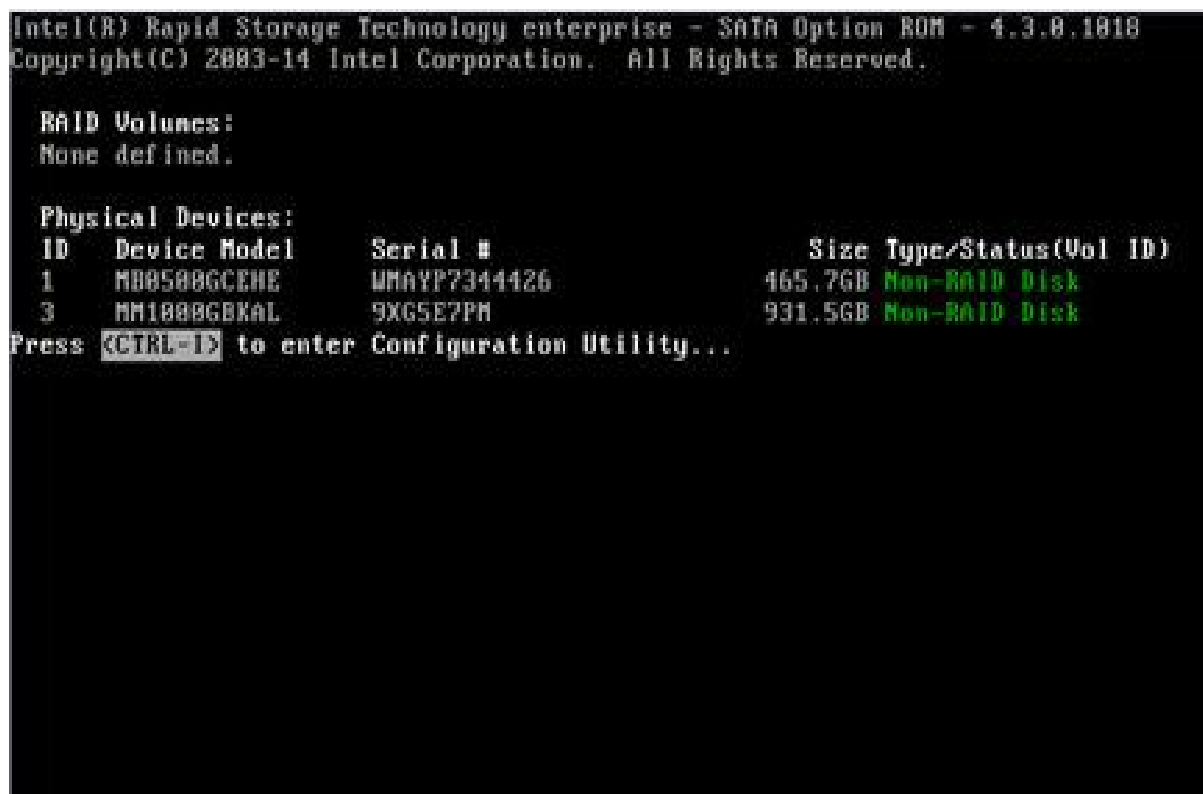

Figure 6- 15

If the working modes of both sSATA and SATA controllers are set to RAID, the prompt "Press <CTRL-I> to enter Configuration Utility" will appear twice during BIOS startup, corresponding to sSATA and SATA controllers in turn. Please configure RAID according to the The desired disk selection controller.

Enter the RSTe configuration interface shown in Figure 6-16 (see Table 1-29 for interface descriptions). Please refer to the key operation tips on the lower border of the interface to navigate and modify settings in the interface. Figure 6-16 RSTe configuration interface



Figure 6- 16

Table 1-37 Description of the RSTe configuration interface

Options	Description
MAIN MENU	On the upper side of the interface, you can perform the following tasks: 1.Create RAID Volume: Configure RAID volume. 2.Delete RAID Volume: Delete RAID volume. 3.Reset Disks to Non-RAID: Clear the RAID configuration information of the disk. 4.Mark Disks as Spare: Configure a hot spare disk. 5.Exit: Exit.
DISK/VOLUME INFORMATION	On the lower side of the configuration interface, you can view the overview information of the created RAID and physical disks.

Table 1- 37

Common tasks

Configure RAID:

Enter the RSTe configuration interface.

As shown in Figure 6-17, select Create RAID Volume on the RSTe configuration interface, and press Enter.

Figure 6-17 RSTe configuration interface



Figure 6- 17

Enter the interface shown in Figure 6-18, and set the Name, RAID Level, Disks, Strip Size, and Capacity columns accordingly (see Table 1-30 for parameter descriptions), select Create Volume, and press Enter.

Figure 6-18 Create RAID Volume interface



Figure 6- 18

Table 1-38 Parameter description

Parameter	Description
Name	The name of the RAID.
RAID Level	RAID level. RAID levels determine logical disk performance, fault tolerance, and capacity.
Disks	Select the member disks that make up the RAID. After selecting the Disks column, press Enter, and press SPACE to select the disk.
Strip Size	Stripe size, the size of the stripe data blocks written on each disk.
Capacity	The capacity of the logical disk.

Table 1- 38

Entering the interface shown in Figure 6-19, you can view the detailed information of the RAID (including the RAID name, level, and included disk information, etc.).

Figure 6-19 RAID information interface



Figure 6- 19

To configure a hot spare disk:

Enter the RSTe configuration interface.

As shown in Figure 6-20, select Mark Disks as Spare on the RSTe configuration interface, and press Enter.

Figure 6-20 RSTe configuration interface

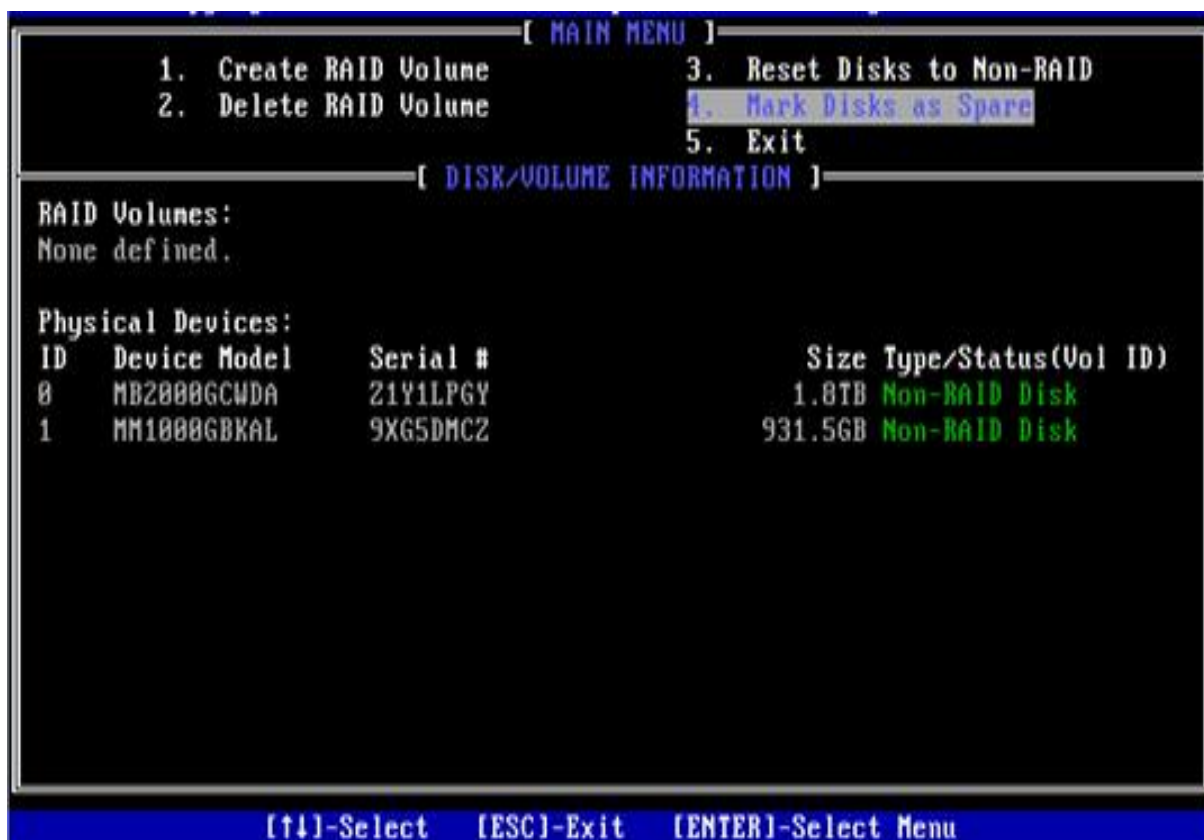

Figure 6- 20

On the interface shown in Figure 6-21, select the disk to be configured as a hot spare disk and press SPACE to select it, then press Enter, enter y in the displayed prompt box, and press Enter to complete the hot spare disk configuration.

Figure 6-21 Select disk

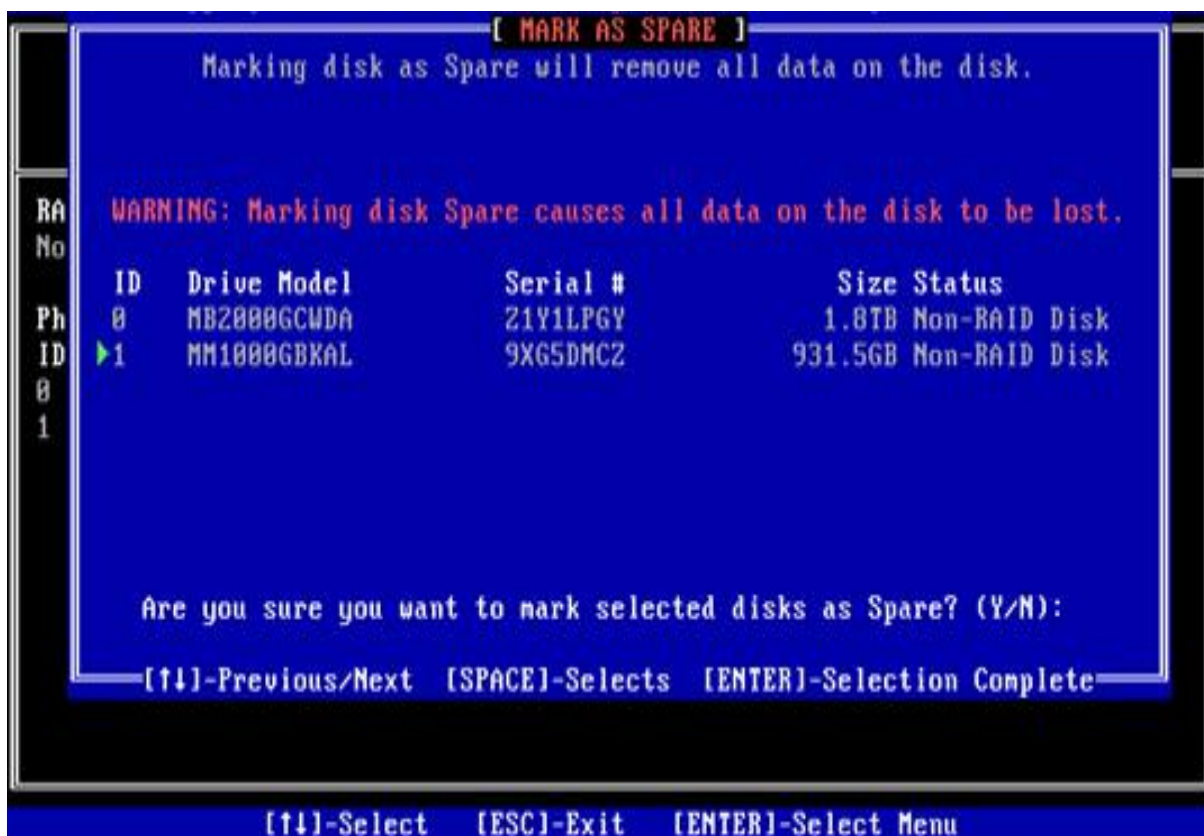

Figure 6- 21

On the RSTe configuration interface, you can view the hot spare disk information, as shown in Figure 6-22.

Figure 6-22 Viewing hot spare disk information on the RSTe configuration interface

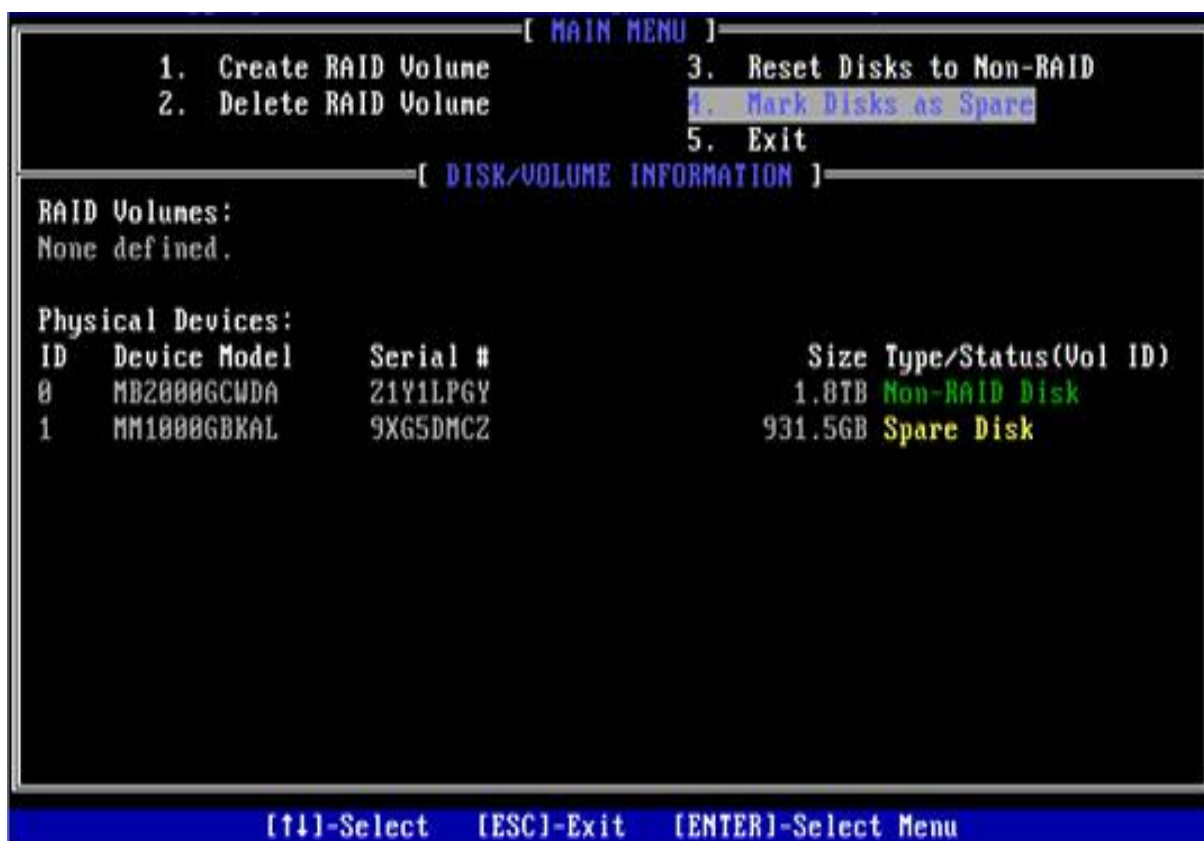

Figure 6- 22

Remove RAID:

Enter the RSTe configuration interface.

As shown in Figure 6-23, select Delete RAID Volume on the RSTe configuration interface, and press Enter.

Figure 6-23 RSTe configuration interface



Figure 6- 23

Enter the interface shown in Figure 6-24, select the RAID to be deleted, and press Delete to complete the deletion.

Figure 6-24 Selecting the RAID to be deleted

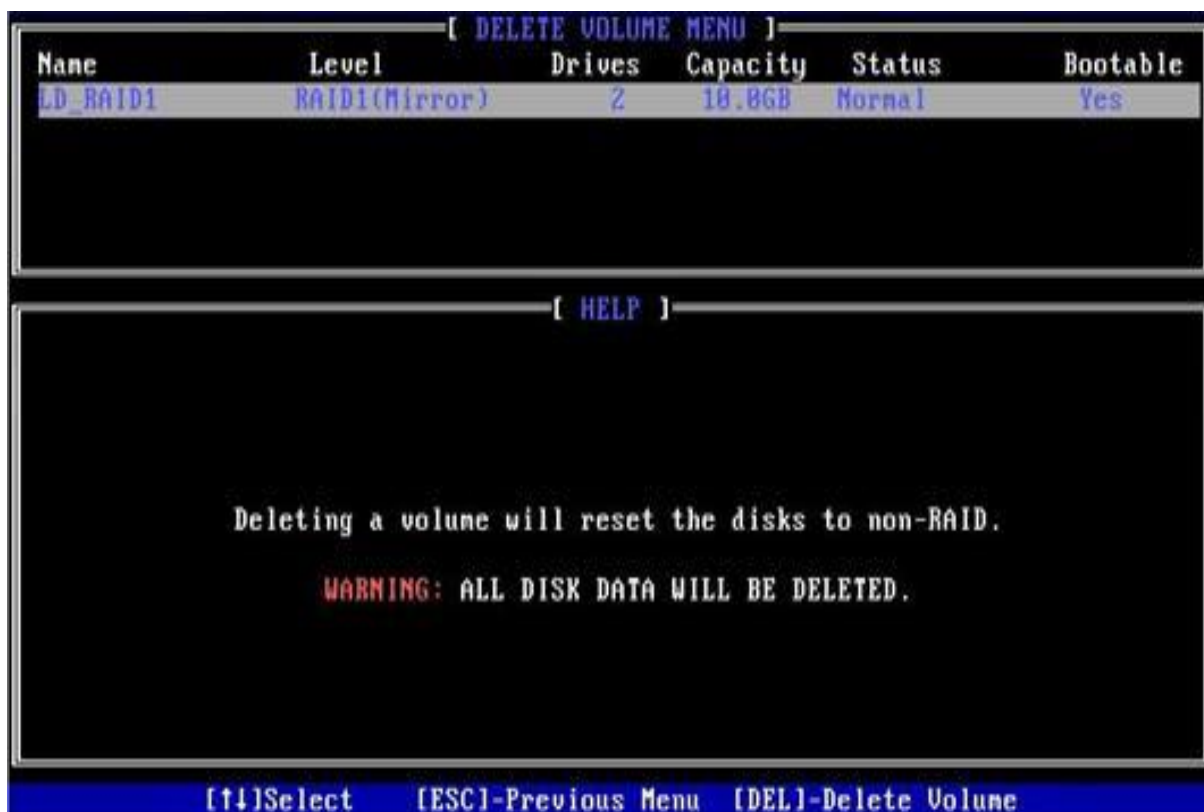

Figure 6- 24

6.2 RAID card set RAID

6.2.1 Configuring RAID in UEFI Boot Mode

Enter the RAID card configuration interface

During the server startup process, press Delete/Esc as prompted to enter the BIOS Setup interface.

Select Advanced>AVAGO MegaRAID<AVAGO MegaRAID SAS 91311-8i>Configuration Utility, and press Enter.

Enter the interface shown in Figure 6-25. Five types of configuration tasks are displayed on the interface (see Table 1-39 for related instructions).

Figure 6-25 RAID card configuration interface, as shown in Figure 6-25

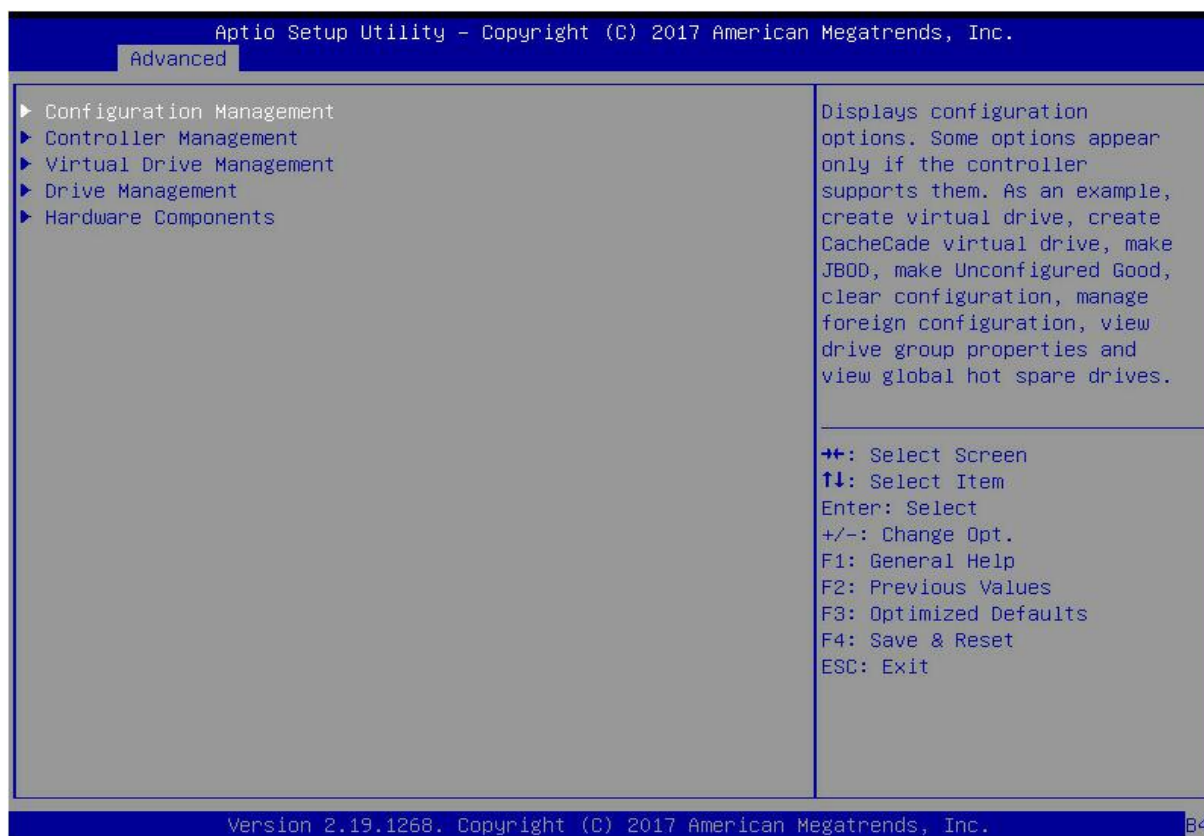

Figure 6- 25

Table 1-39 Parameter description

Options	Overview
Configuration Management	Select Configuration Management to perform tasks such as creating logical disks, viewing disk group properties, viewing hot spare information, and clearing configurations.
Controller Management	Select Controller Management to view and manage controller properties and perform tasks such as clearing controller events, scheduling and running controller events, and running patrol reads.
Virtual Drive Management	Select Logical Disk Management to perform tasks such as viewing logical disk properties, locating logical disks, and running consistency checks.
Drive Management	Select Disk Management to view physical disk properties and perform tasks such as locating disks, initializing disks, and rebuilding after disk failures.
Hardware Components	Select Hardware Components to view supercapacitor properties, manage supercapacitors, and manage peripheral components.

Table 1- 39

Common tasks

Switch disk mode:

The RAID card supports switching between the following three disk modes.

Unconfigured Good: Indicates that the physical disk is normal and can be used to configure RAID or hot spare disks.

Unconfigured Bad: Indicates that there is residual RAID information on the physical disk and needs to be cleared manually.

JBOD: Just a Bunch Of Disks, it only concatenates the disks together for capacity expansion, but does not have the RAID function.

Here is an example of switching from Unconfigured Good mode to Unconfigured Bad mode.

As shown in Figure 6-26, select Drive Management on the RAID card configuration interface, and press Enter.

Figure 6-26 RAID card configuration interface

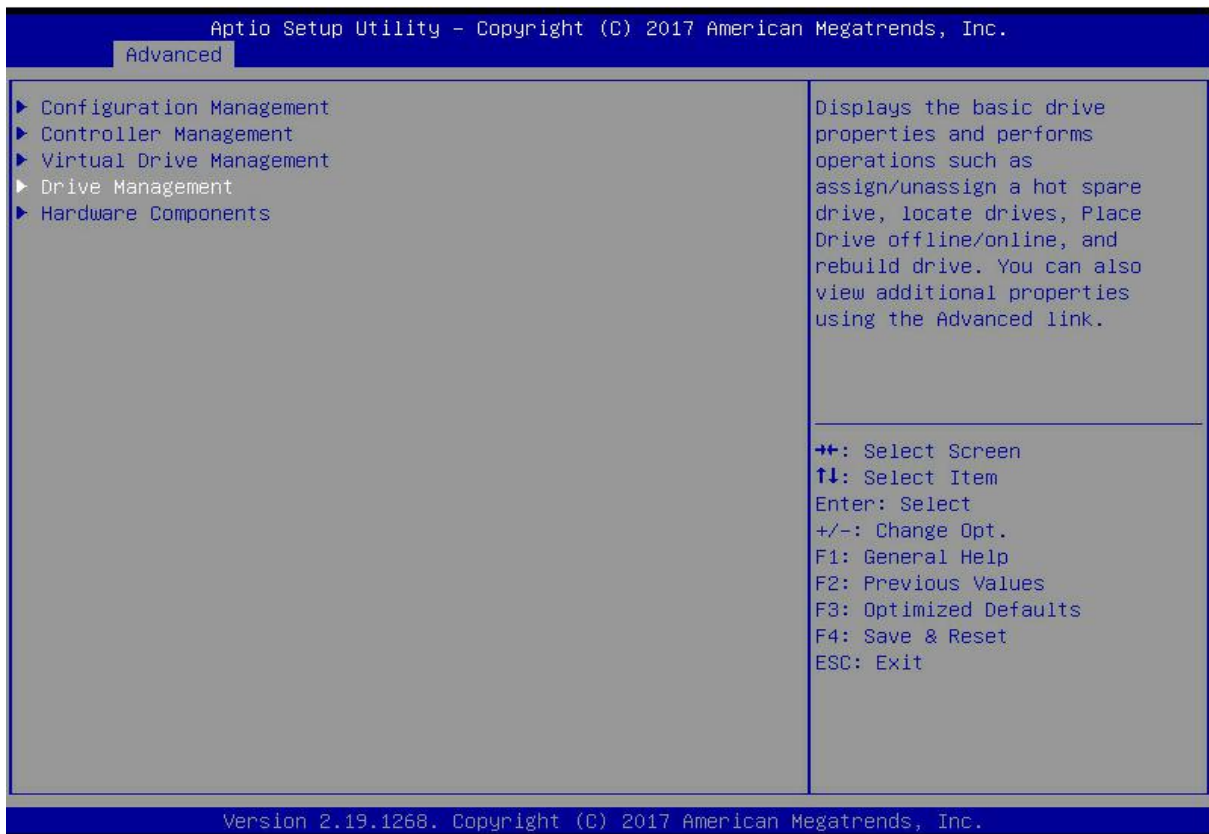

Figure 6- 26

The interface shown in Figure 6-27 is displayed, select the disk to be configured, and press Enter.

Figure 6-27 Drive Management management interface

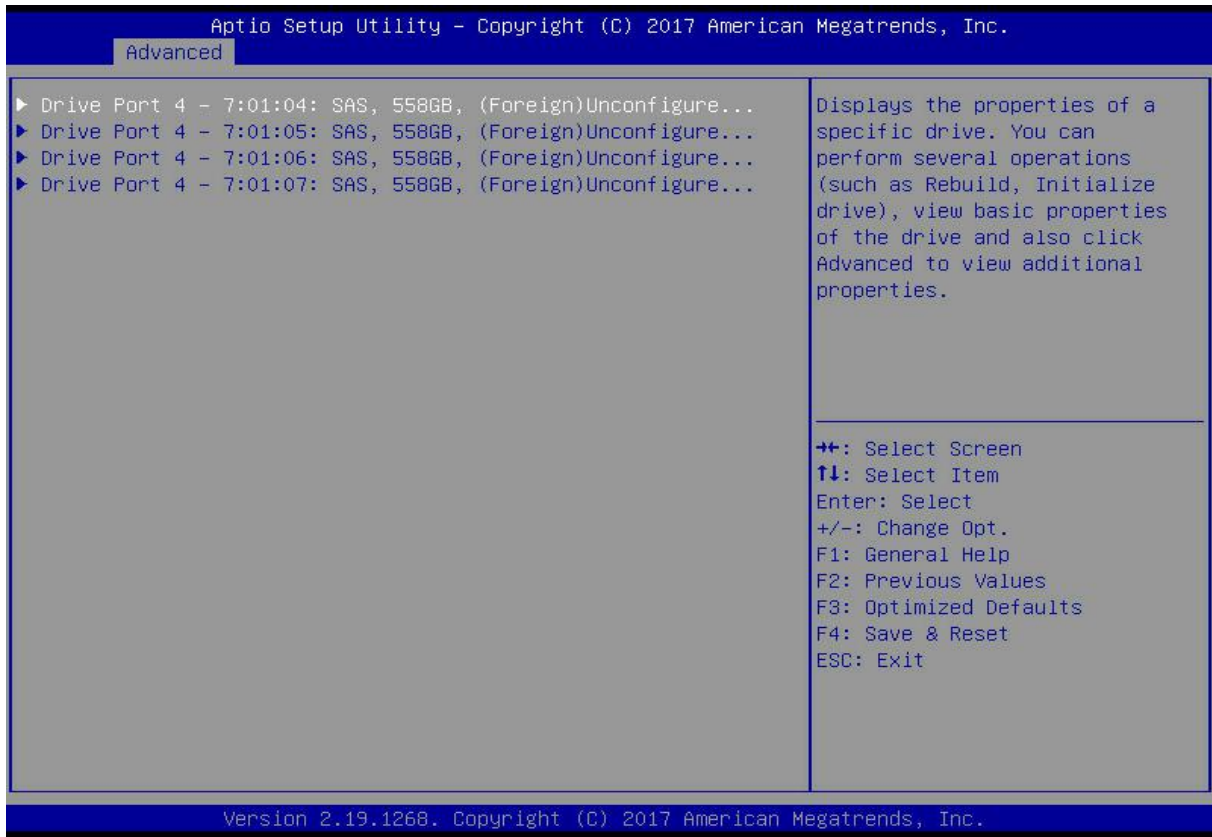

Figure 6- 27

Enter the interface shown in Figure 6-28, select Operation, and press Enter. In the displayed dialog box, select Make Unconfigured Bad, and press Enter.

Figure 6-28 Operation interface

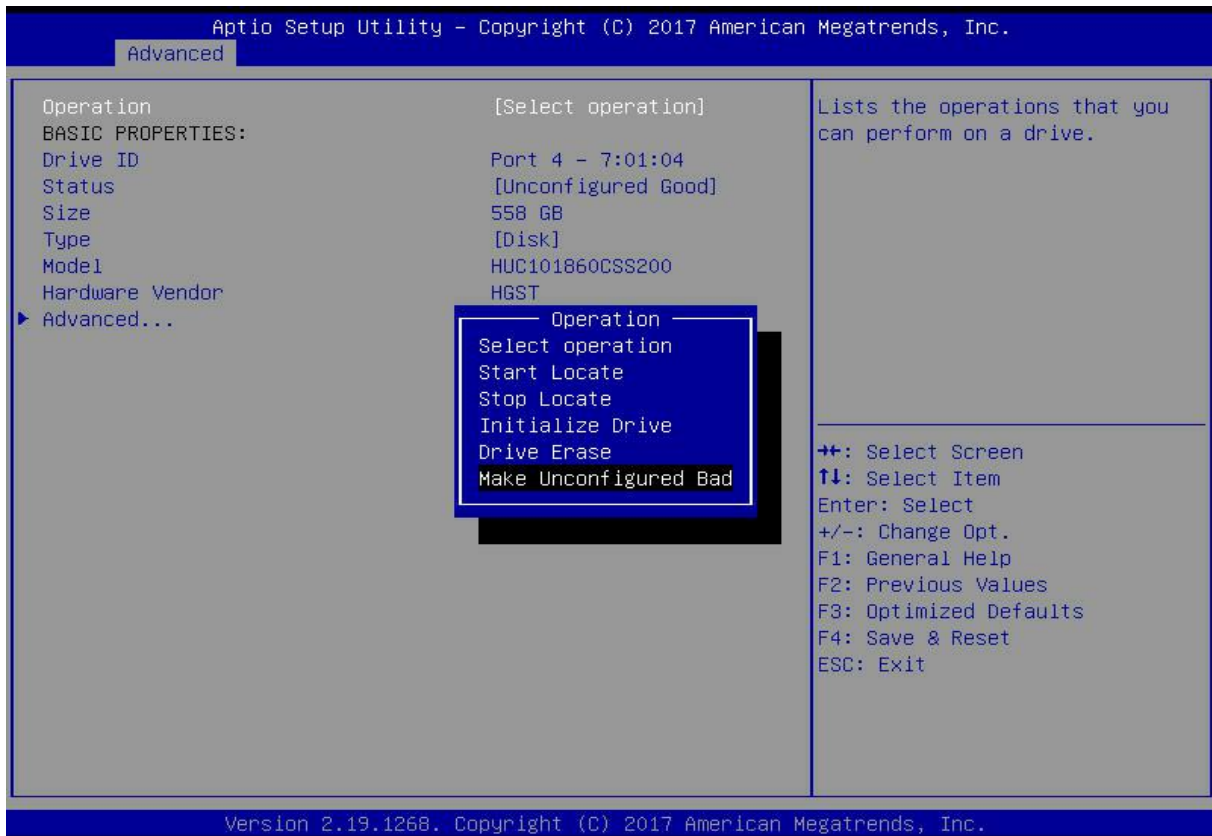

Figure 6- 28

Enter the interface shown in Figure 6-29, select Go, and press Enter.

Figure 6-29 Select Go

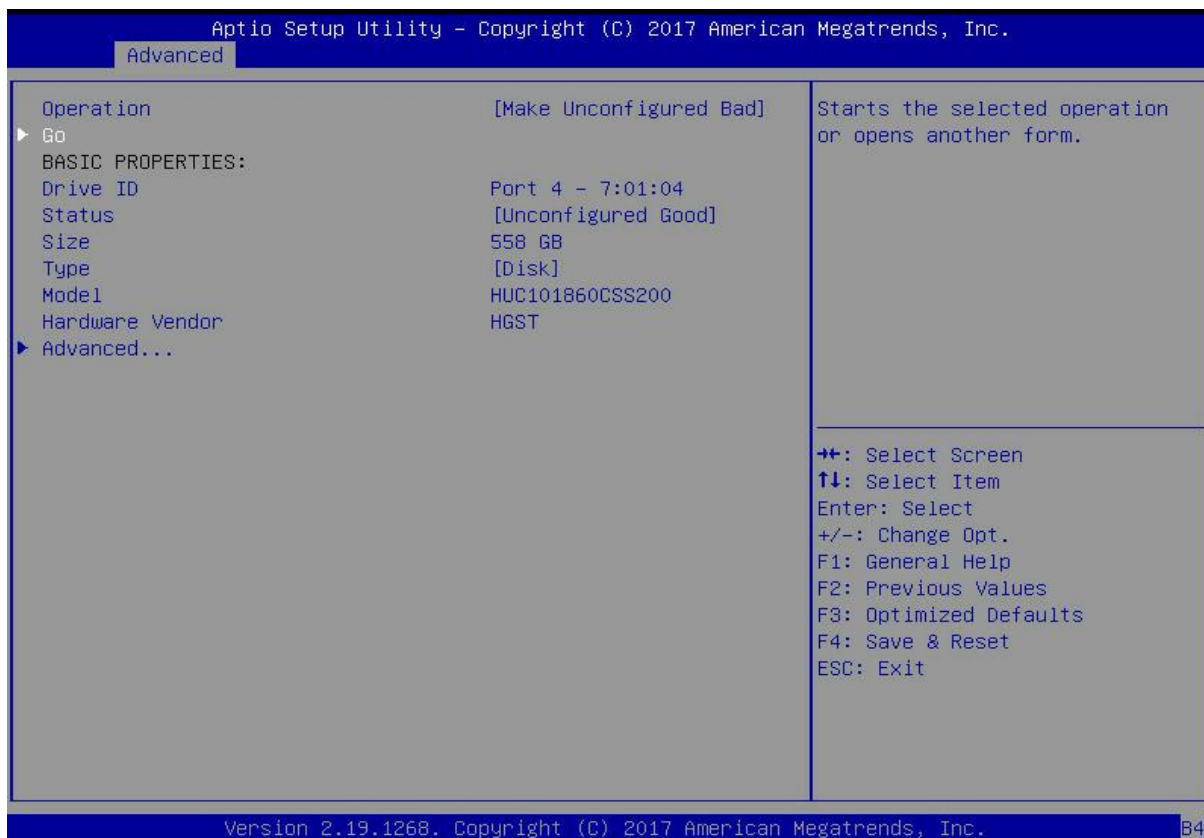

Figure 6- 29

Enter the interface shown in Figure 6-30 and complete the operation of switching the disk mode.

Figure 6-30 Complete switching disk mode



Figure 6- 30

Create RAID:

As shown in Figure 6-31, select Configuration Management on the RAID card configuration interface, and press Enter.

Figure 6-31 RAID card configuration interface

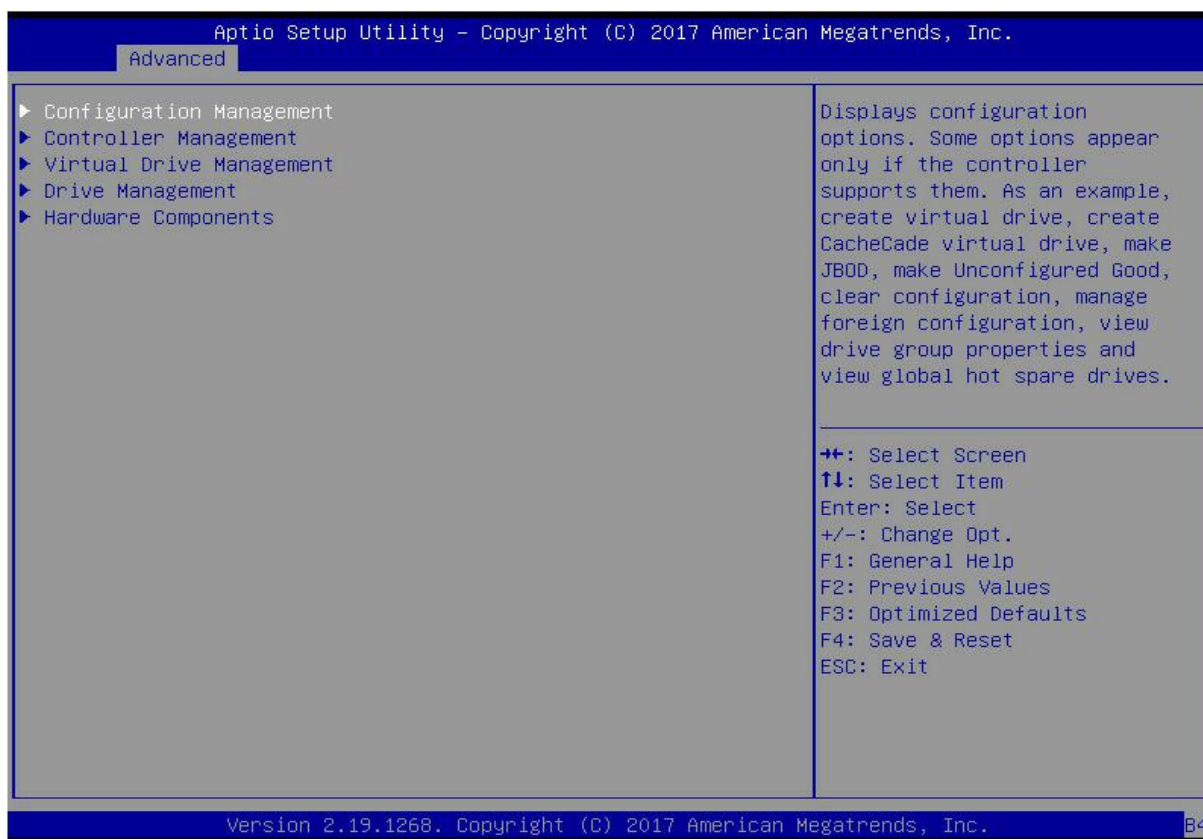

Figure 6- 31

Enter the interface shown in Figure 6-32, select Create Virtual Drive, and press Enter.

Figure 6-32 Select Create Virtual Drive

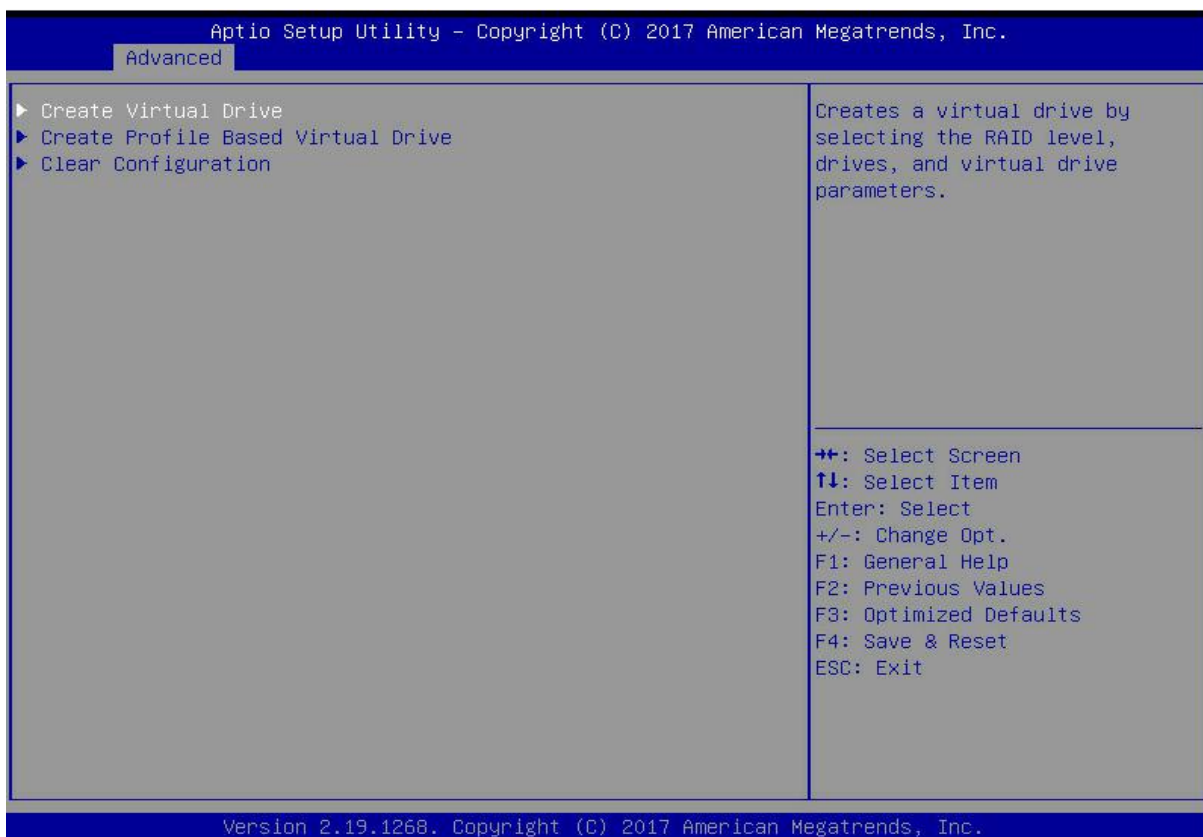

Figure 6- 32

On the interface shown in Figure 6-33, select Select RAID Level, set the RAID level, and press Enter.

Figure 6-33 Setting the RAID level

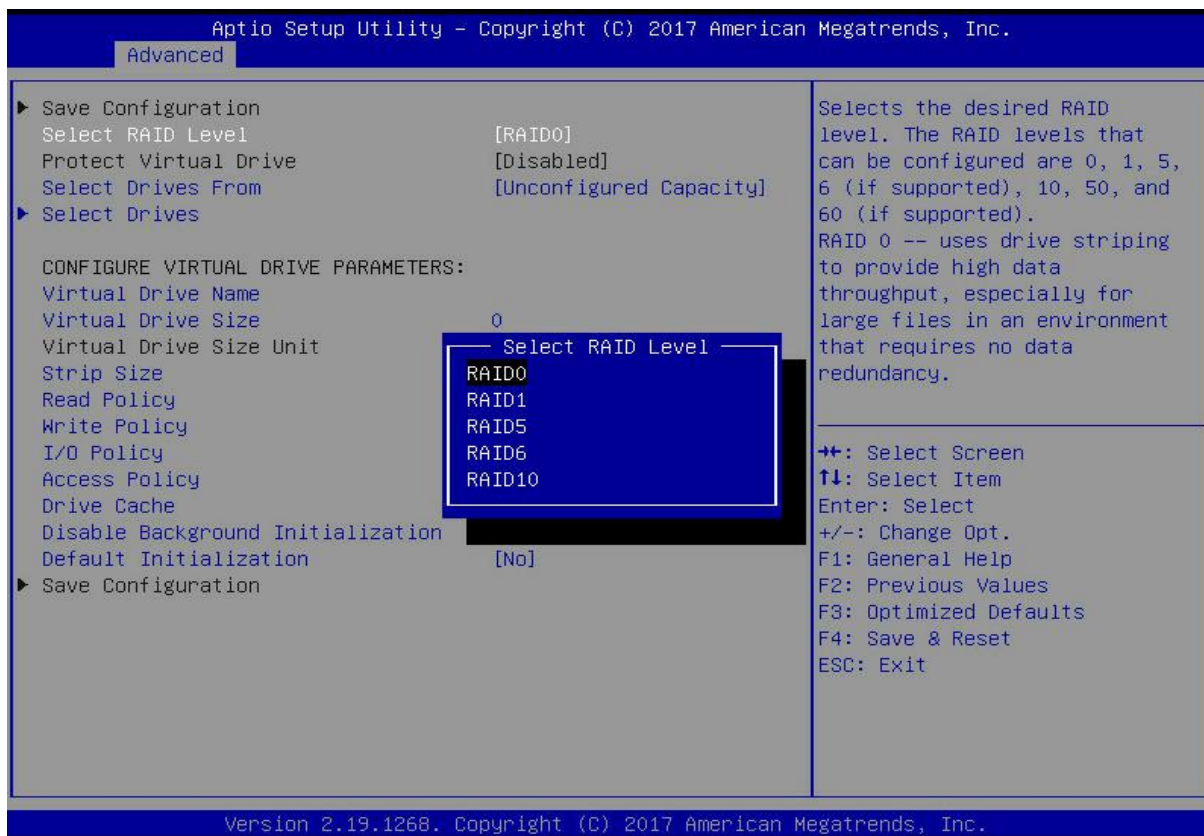

Figure 6- 33

Enter the interface shown in Figure 6-34, select Select Drives From, set the RAID disk capacity source, and press Enter.

[Unconfigured Capacity] indicates that the capacity comes from the remaining capacity of the RAID-configured disk.

[Free Capacity] indicates that the capacity comes from an empty disk.

Figure 6-34 Setting the disk capacity source of RAID

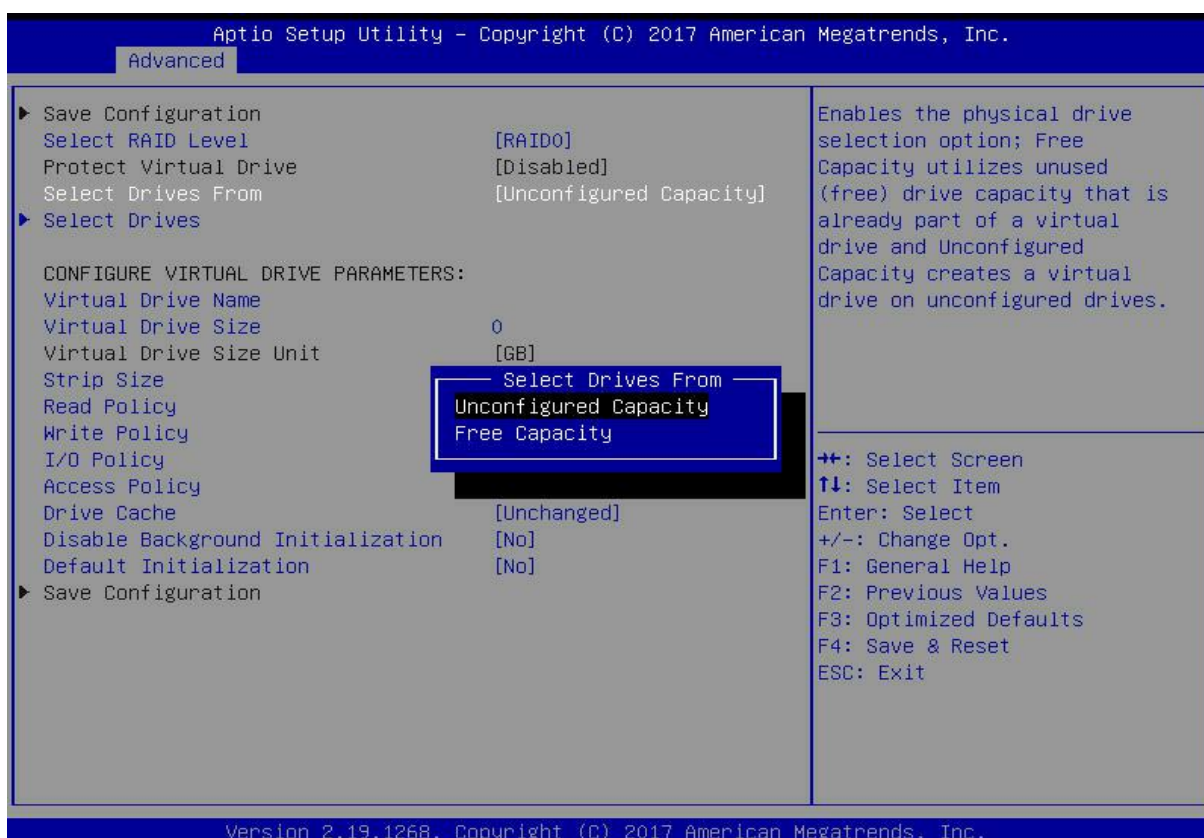

Figure 6- 34

Enter the interface shown in Figure 6-35, select Select Drives, and press Enter.

Figure 6-35 Select Select Drives

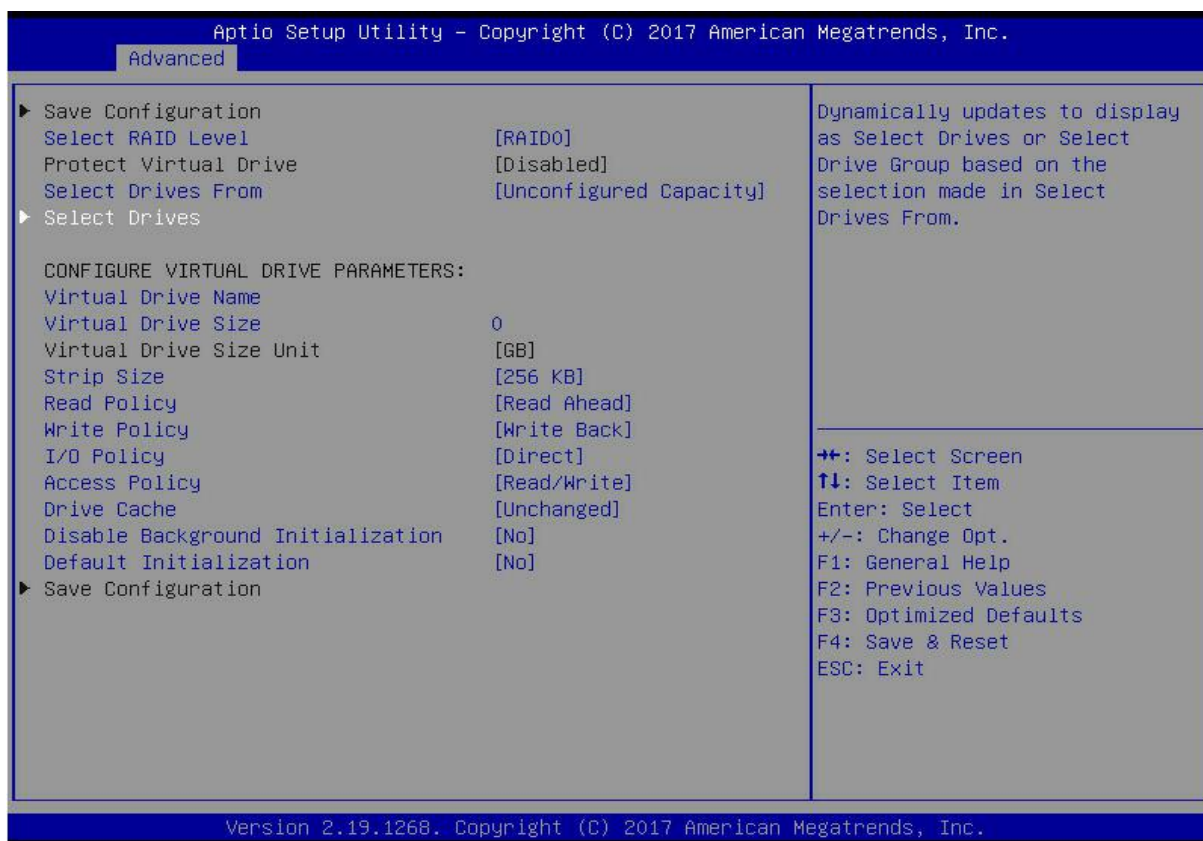

Figure 6- 35

Enter the interface shown in Figure 6-36, select the disk to be used to configure RAID, [Enabled] means selected, then select Apply Changes, and press Enter. If the status of the disk is JBOD or Unconfigured Bad, it cannot be selected.

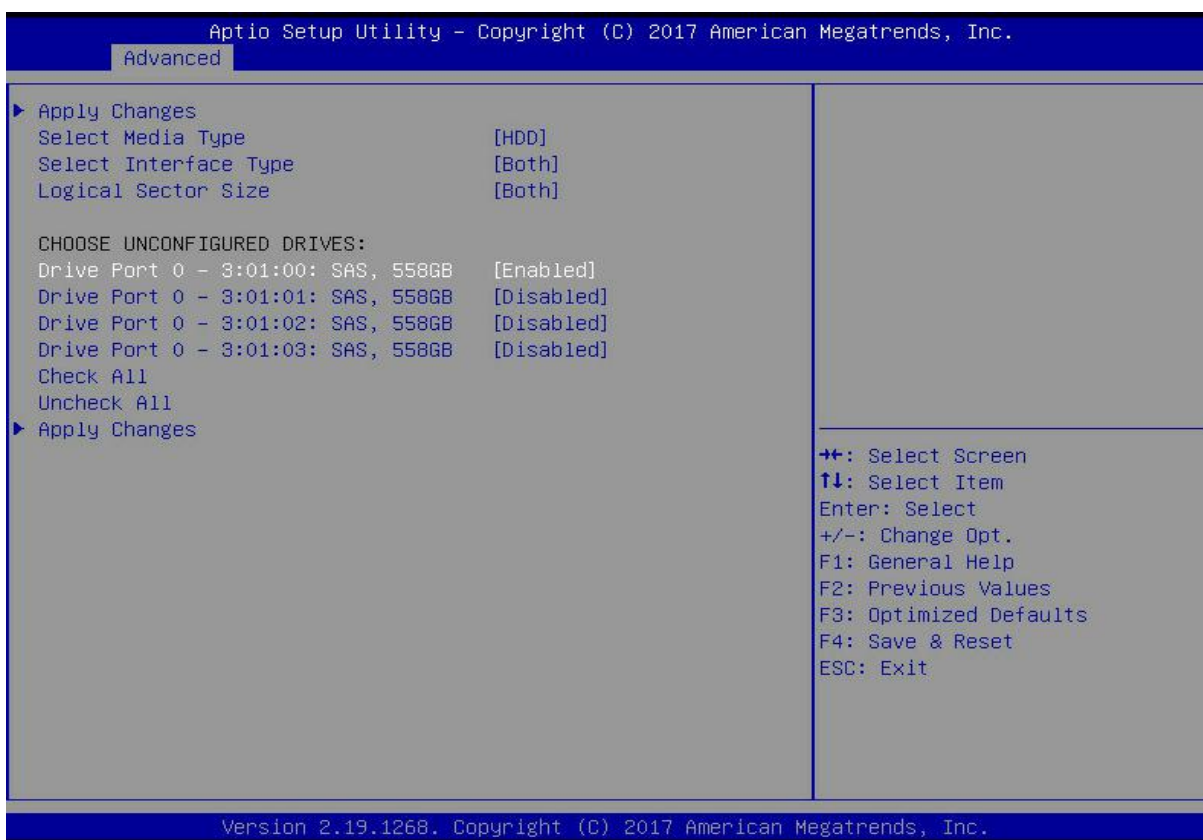

Figure 6- 36

Enter the interface shown in Figure 6-37, make corresponding settings (see Table 1-32 for parameter descriptions), select Save Configuration, and press Enter.

Figure 6-37 Setting RAID parameters

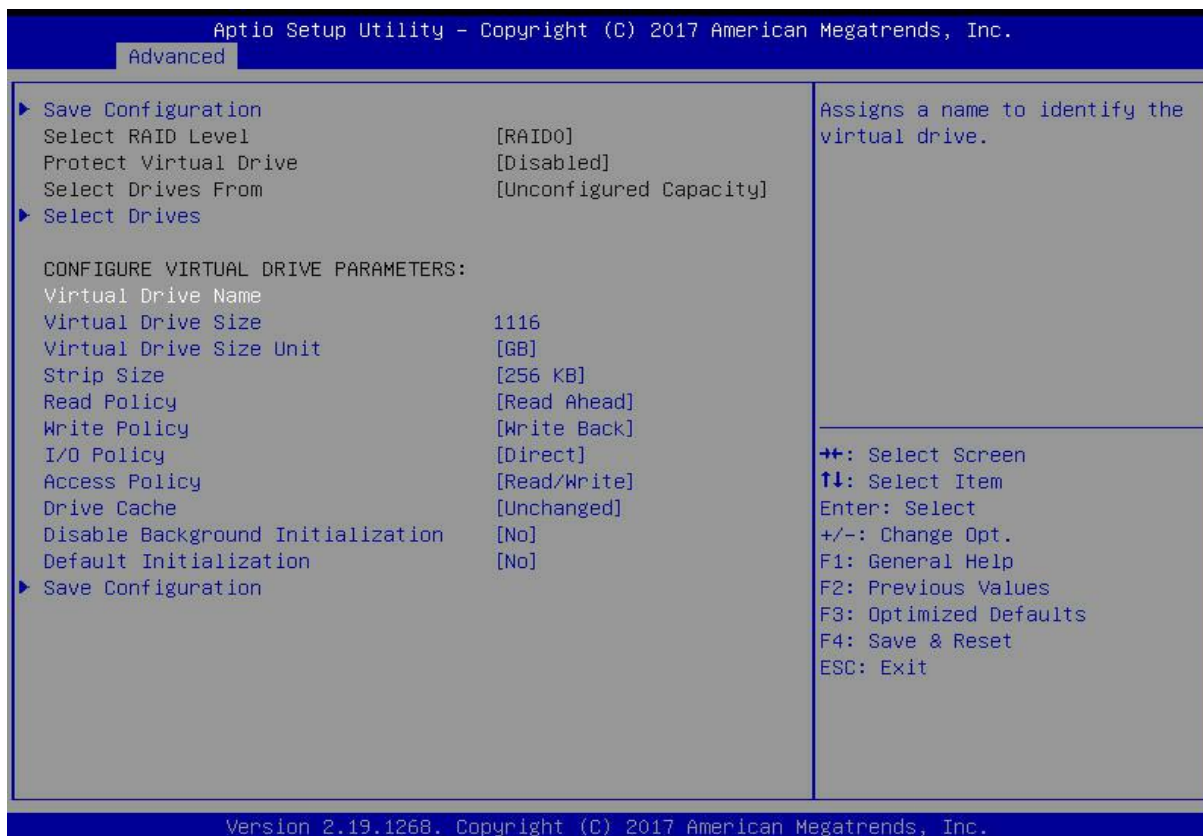

Figure 6- 37

Parameter Description

Parameter	Description
Virtual Drive Name	The name of the RAID, only supports letters, numbers and underscores, case-insensitive
Virtual Drive Size	RAID capacity
Virtual Drive Size Unit	RAID capacity unit
Stripe Size	Stripe size, the size of the stripe data blocks written on each disk
Read Policy	Read cache strategy, divided into Read Ahead (open read cache) and No Read Ahead (close read cache)
Write Policy	Write caching strategy, divided into Write Through (write-through mode), Always Write Back (write-back mode 1) and Write Back (write-back mode 2)
I/O Policy	I/O strategy, divided into Cached (cache mode) and Direct (direct read and write mode)
Access Policy	Read and write strategy, divided into Read/Write (read/write), Read Only (read-only) and Blocked (forbidden operation)
Drive Cache	Disk cache strategy, divided into Enable (open), Disable (close) and Unchanged (automatic)
Default Initialization	Default initialization method
Save Configuration	Save the configuration created by the wizard

Table 1- 40

Do not use special characters as RAID names.

Compared with No Read Ahead, Write Through, and Direct, Read Ahead, Write Back, and Cached have improved performance, but data consistency cannot be guaranteed.

If the supercapacitor is abnormal, when the write cache policy is set to "Write Back", the firmware will implement "Write Through" for writing data; if the write cache policy is set to "Always Write Back", the firmware write data will implement "Write Back".

Enter the interface shown in Figure 6-38, select Confirm to enable it, select Yes, and press Enter.

Figure 6-38 Confirm the configuration

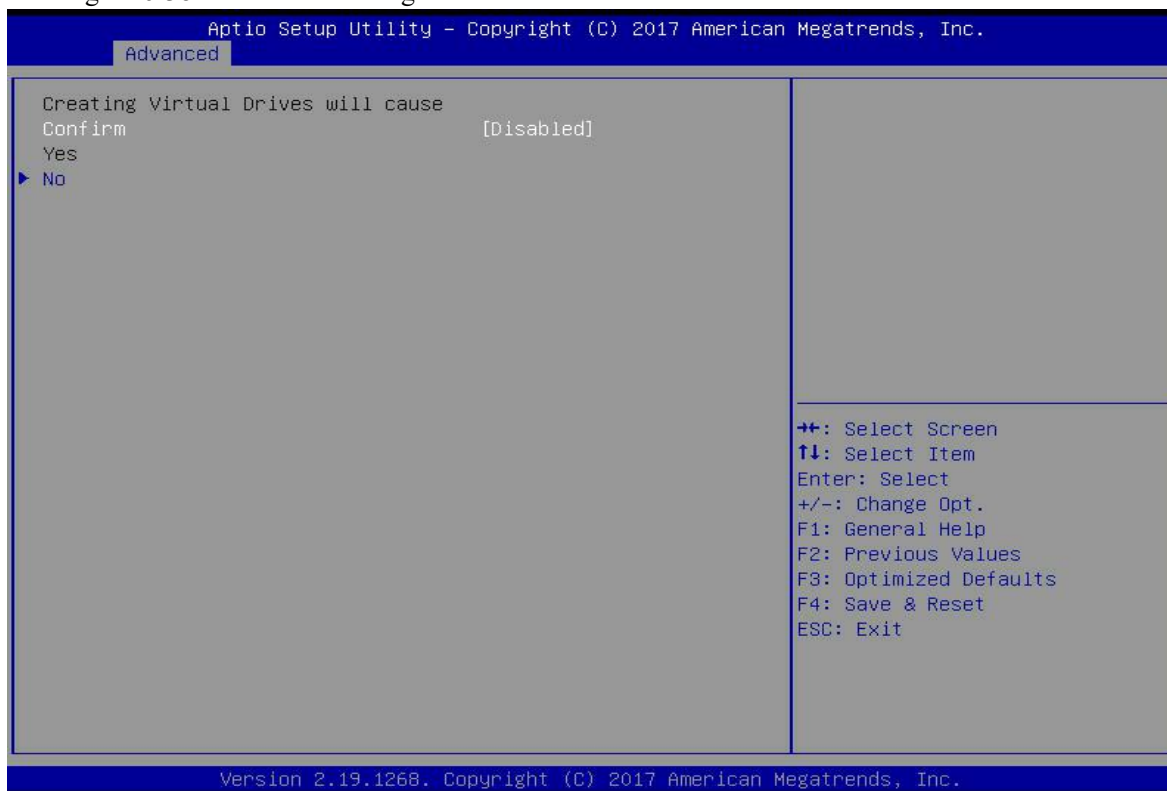

Figure 6-38

Enter the interface shown in Figure 6-39, complete the RAID configuration operation, and select OK to return to the RAID card configuration interface.

Figure 6-39 Complete the RAID configuration

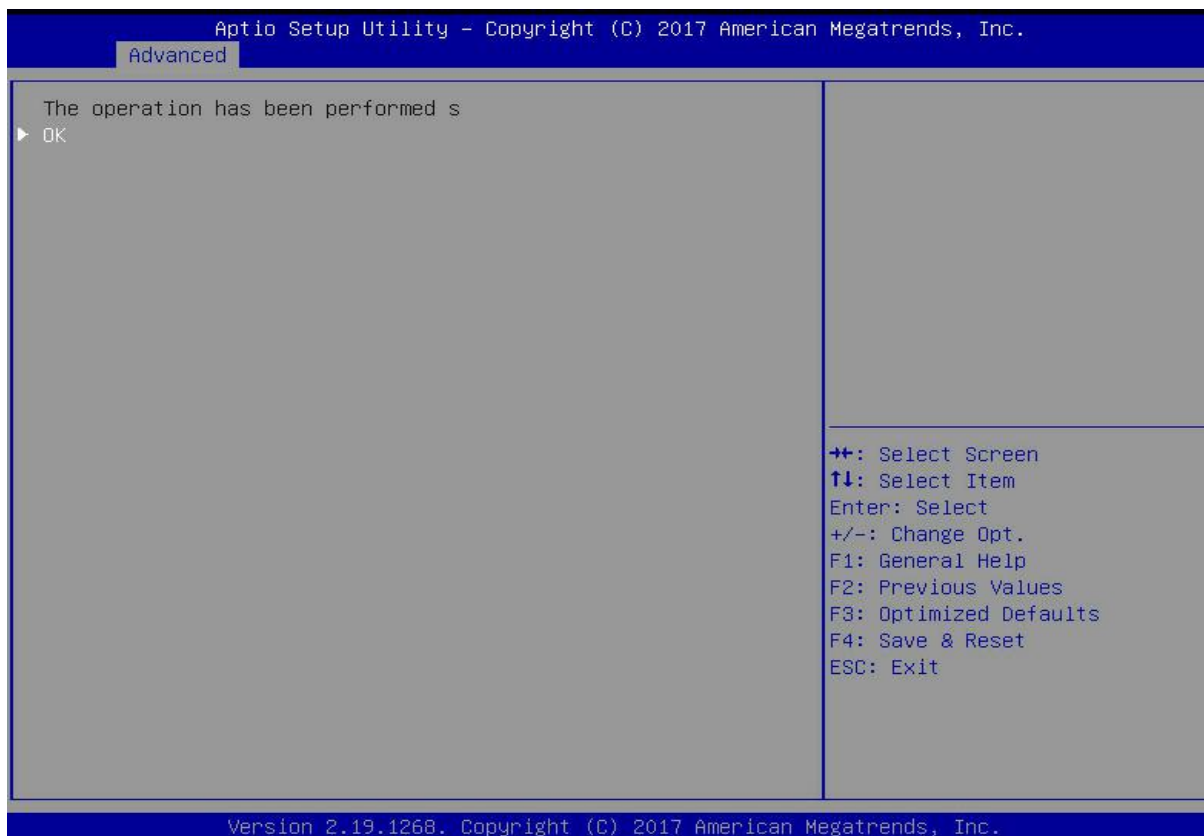

Figure 6- 39

As shown in Figure 6-40, select Virtual Drive Management on the RAID card configuration interface, and press Enter.

Figure 6-40 RAID card configuration interface

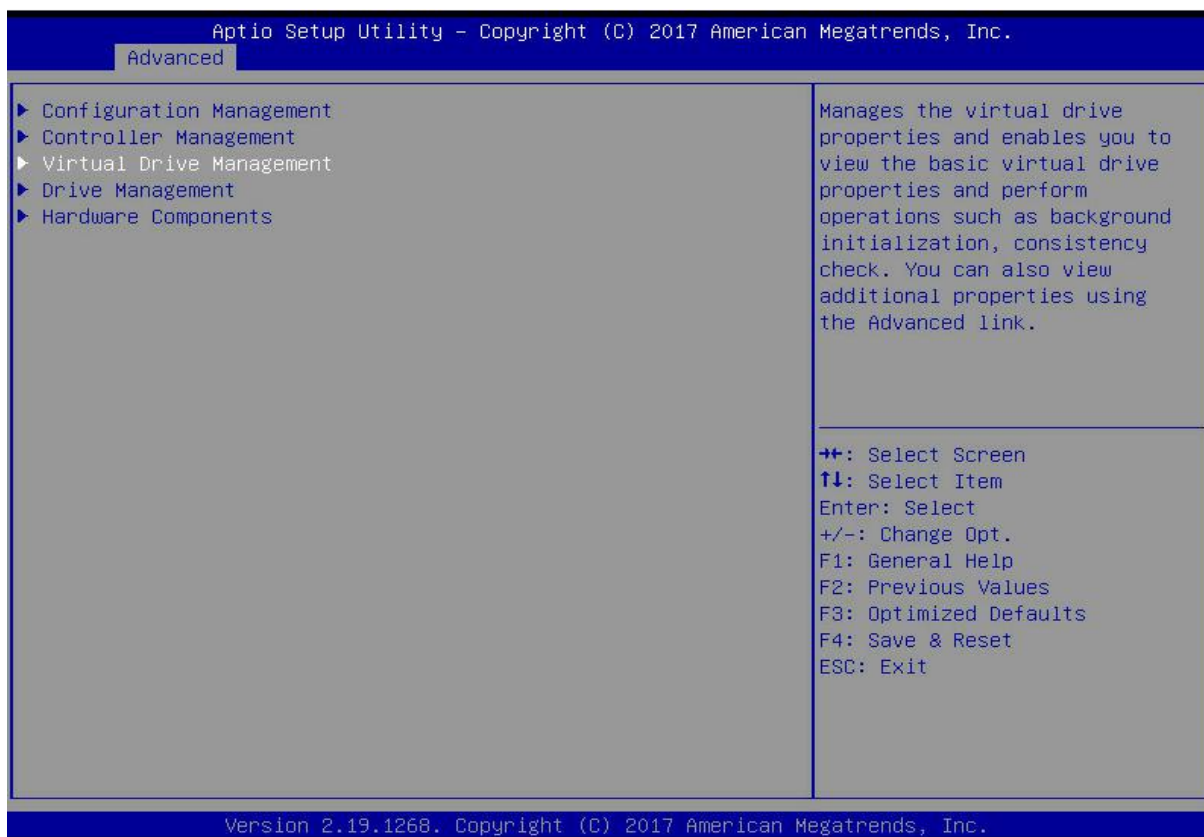

Figure 6- 40

On the interface shown in Figure 6-41, you can see the created RAID, select the RAID to be viewed, and press Enter.

Figure 6-41 Virtual Drive Management interface

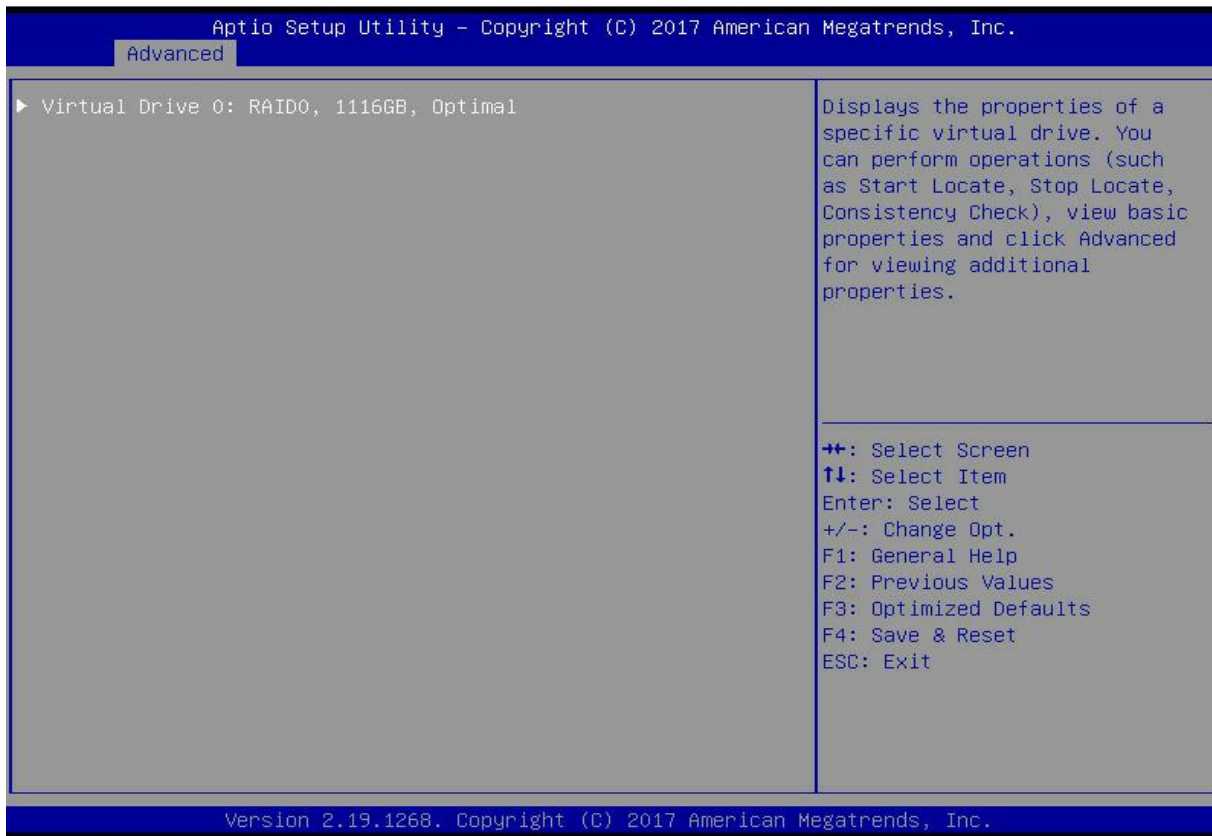

Figure 6- 41

Enter the interface shown in Figure 6-42, select View Associated Drives, and press Enter to view the detailed information of the RAID (including RAID name, level, and disk information, etc.).

Figure 6-42 Select View Associated Drives

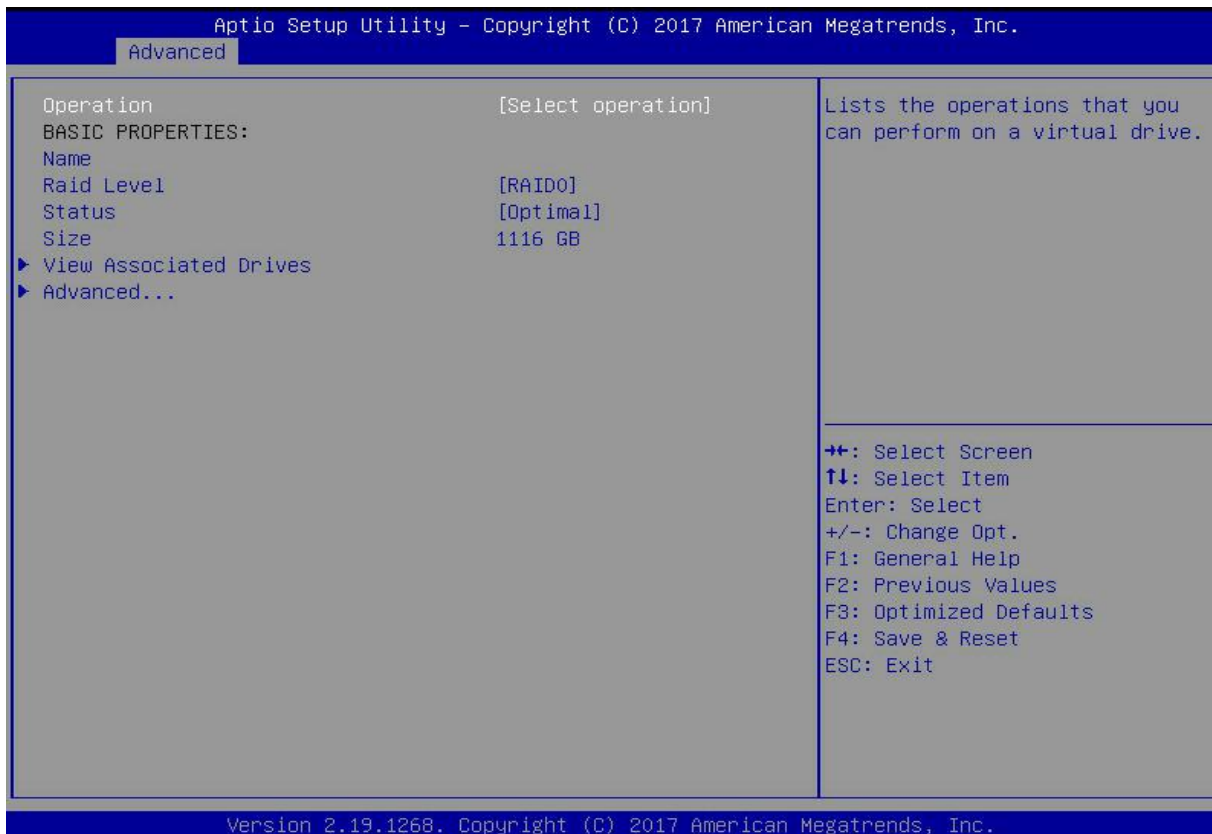

Figure 6- 42

To configure a hot spare disk:

After configuring RAID, a hot spare disk is generally configured to improve data security. A global hot spare disk or a dedicated hot spare disk can be configured as required.

Hot spares are only used for RAID levels where redundancy exists.

The capacity of the hot spare disk is larger than the capacity of a single RAID member disk to contribute to the RAID.

Only disks whose configuration mode is Unconfigured Good are supported as hot spare disks.

Configuring a global hot spare

As shown in Figure 6-43, select Drive Management on the RAID card configuration interface, and press Enter.

Figure 6-43 RAID card configuration interface

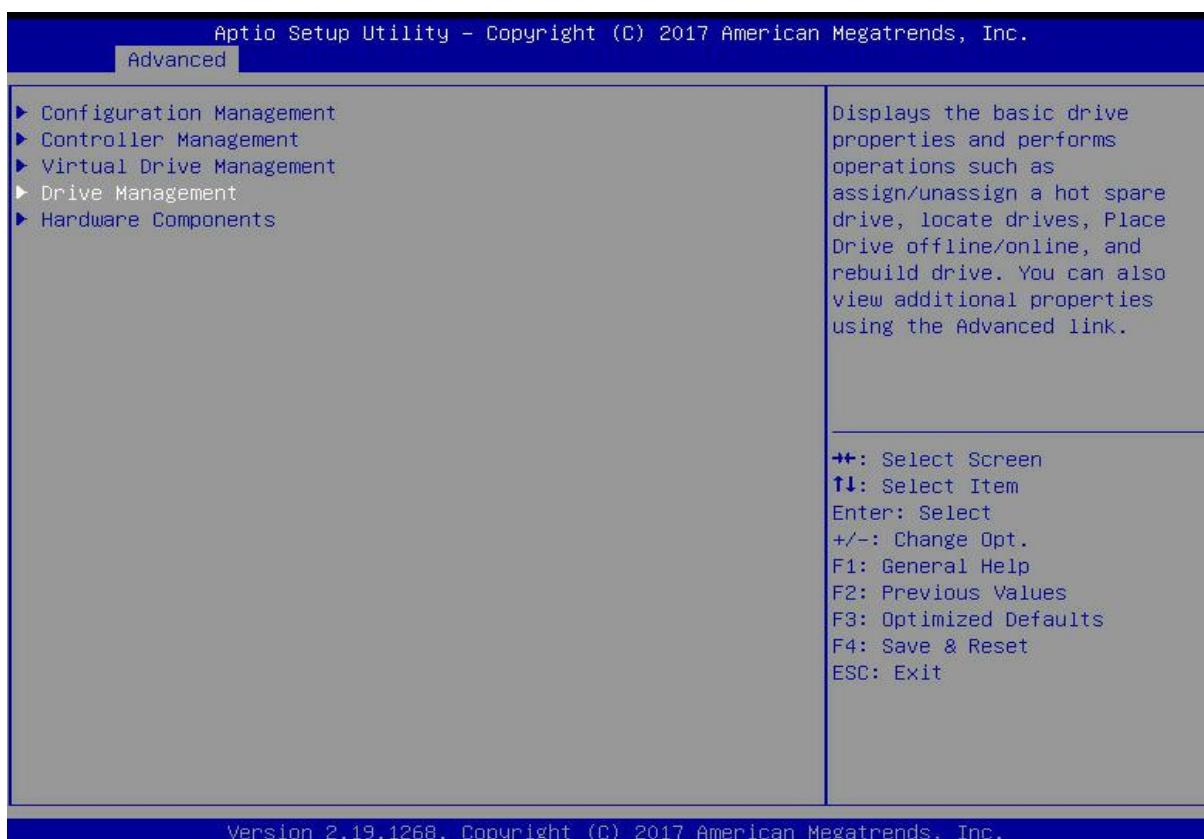

Figure 6- 43

On the interface shown in Figure 6-44, select the disk to be configured as a global hot spare, and press Enter.

Figure 6-44 Drive Management management interface



Figure 6- 44

On the interface shown in Figure 6-45, select Operation, press Enter, then select Assign Dedicated Hot Spare Drive, and press Enter.

Figure 6-45 Operation interface

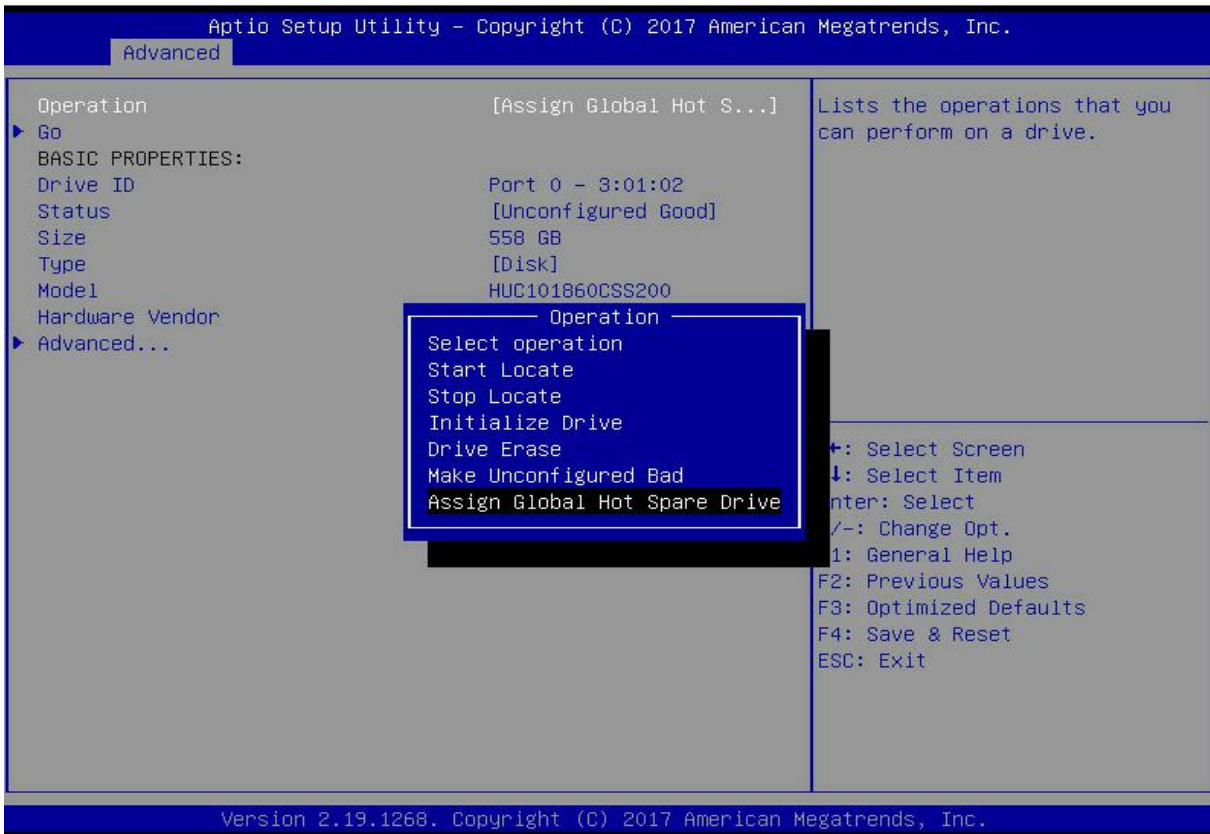

Figure 6-45

Enter the interface shown in Figure 6-46, select Go, and press Enter.

Figure 6-46 Select Go

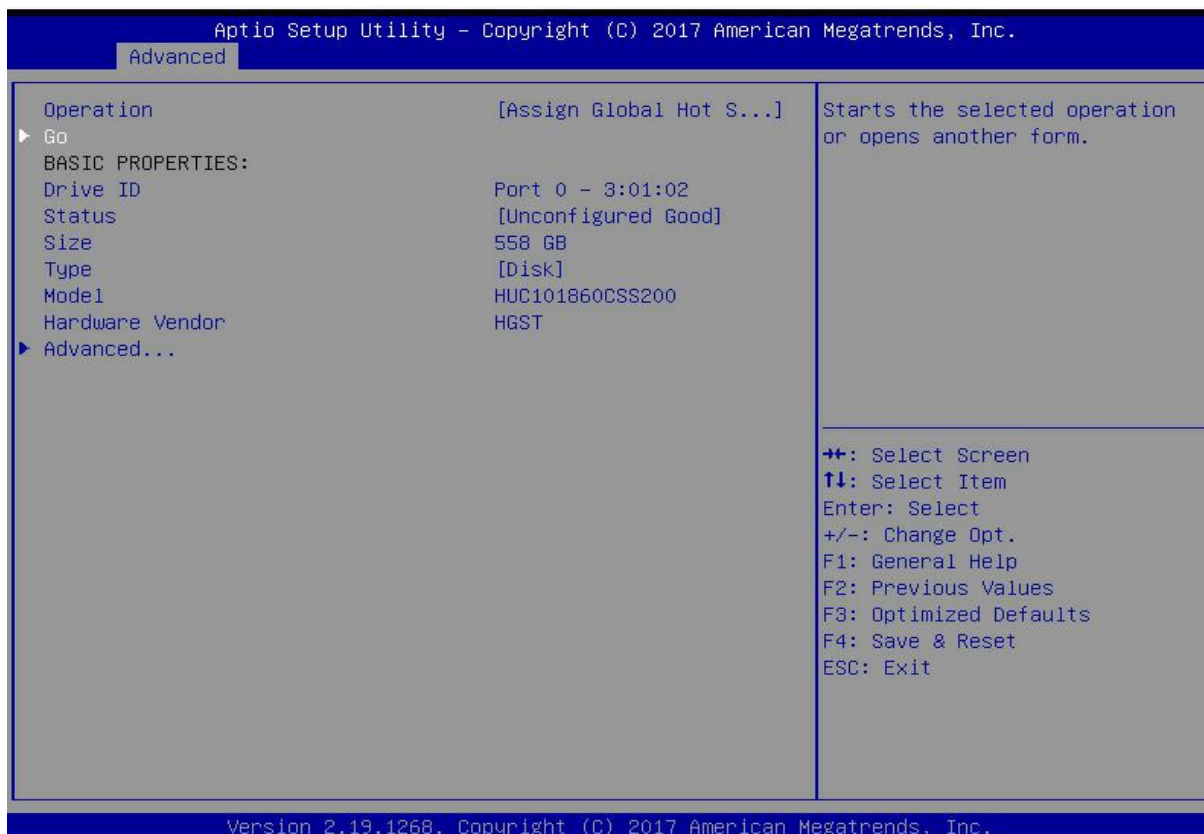

Figure 6- 46

Enter the interface shown in Figure 6-47, select Confirm to enable it, select Yes, and press Enter.

Figure 6-47 Confirm the configuration

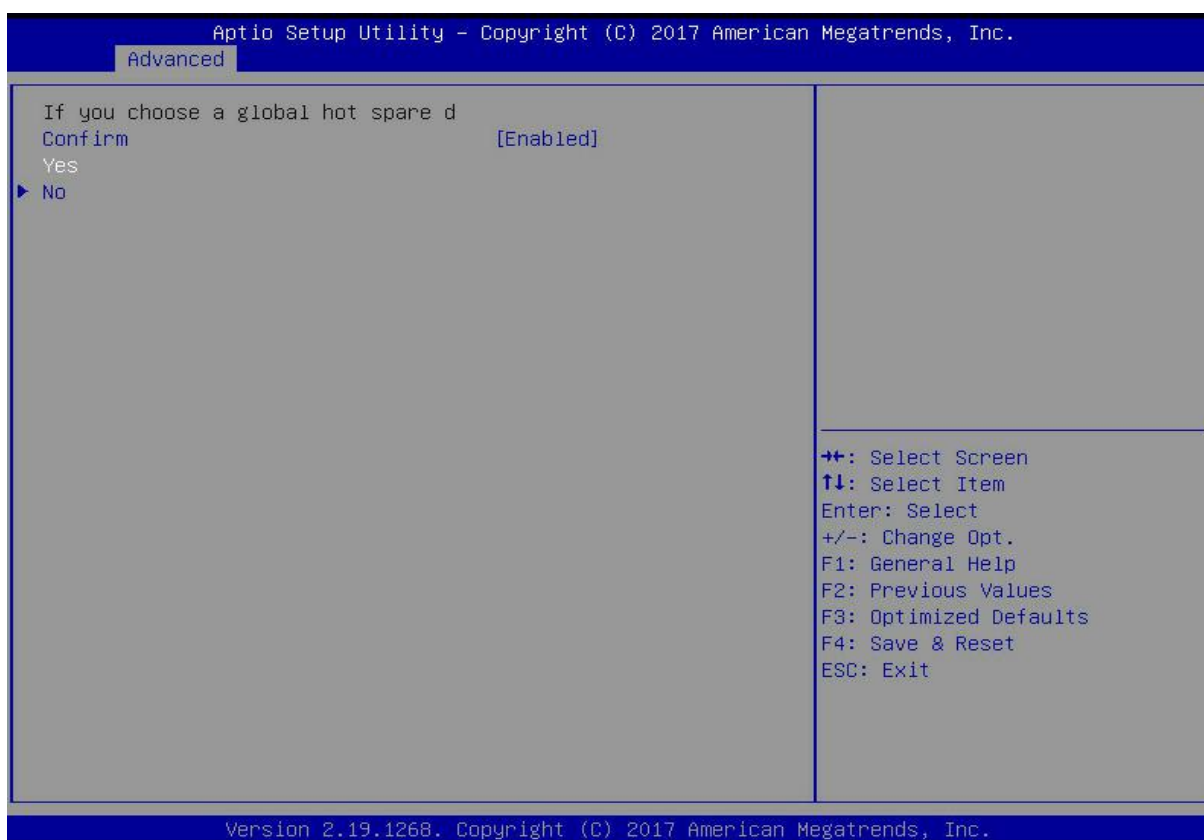

Figure 6- 47

Enter the interface shown in Figure 6-48 and complete the operation of configuring the global hot spare disk.

Figure 6-48 Complete the configuration of the global hot spare disk

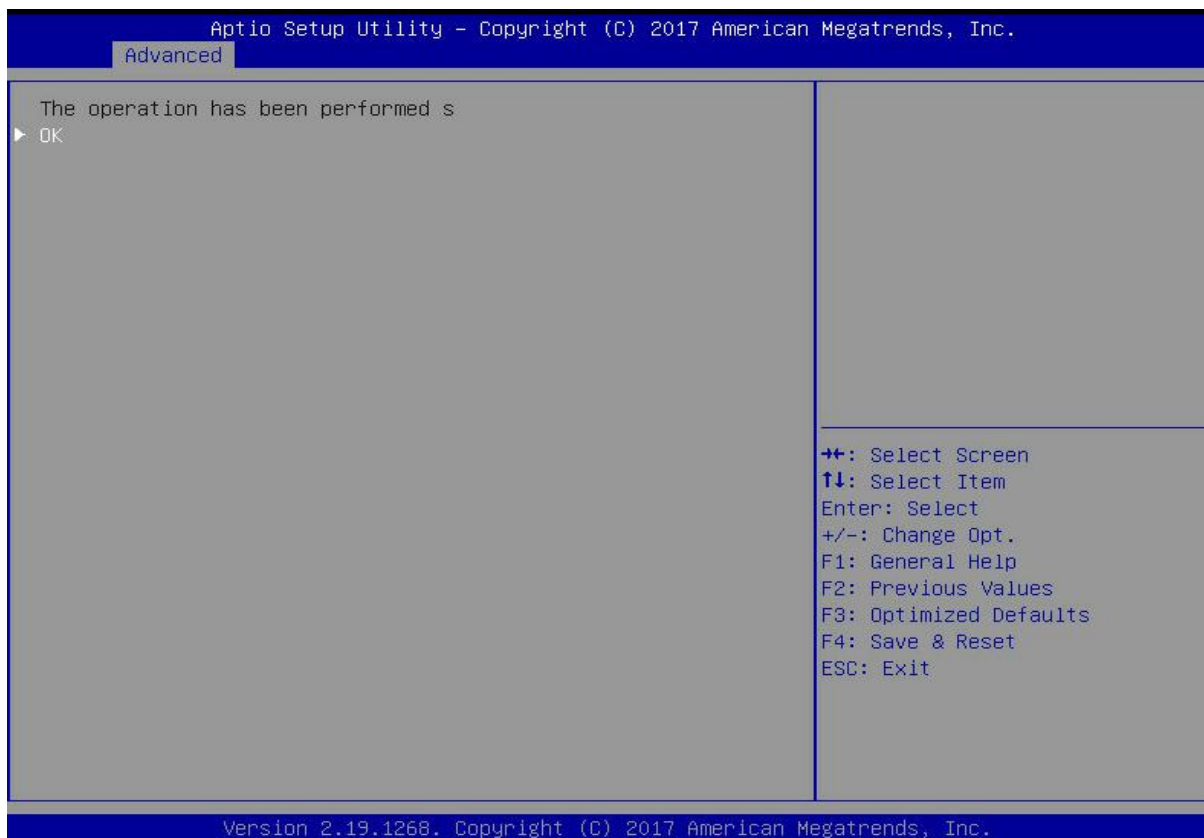

Figure 6- 48

Remove RAID:

As shown in Figure 6-49, select Virtual Drive Management on the RAID card configuration interface, and press Enter.

Figure 6-49 RAID card configuration interface

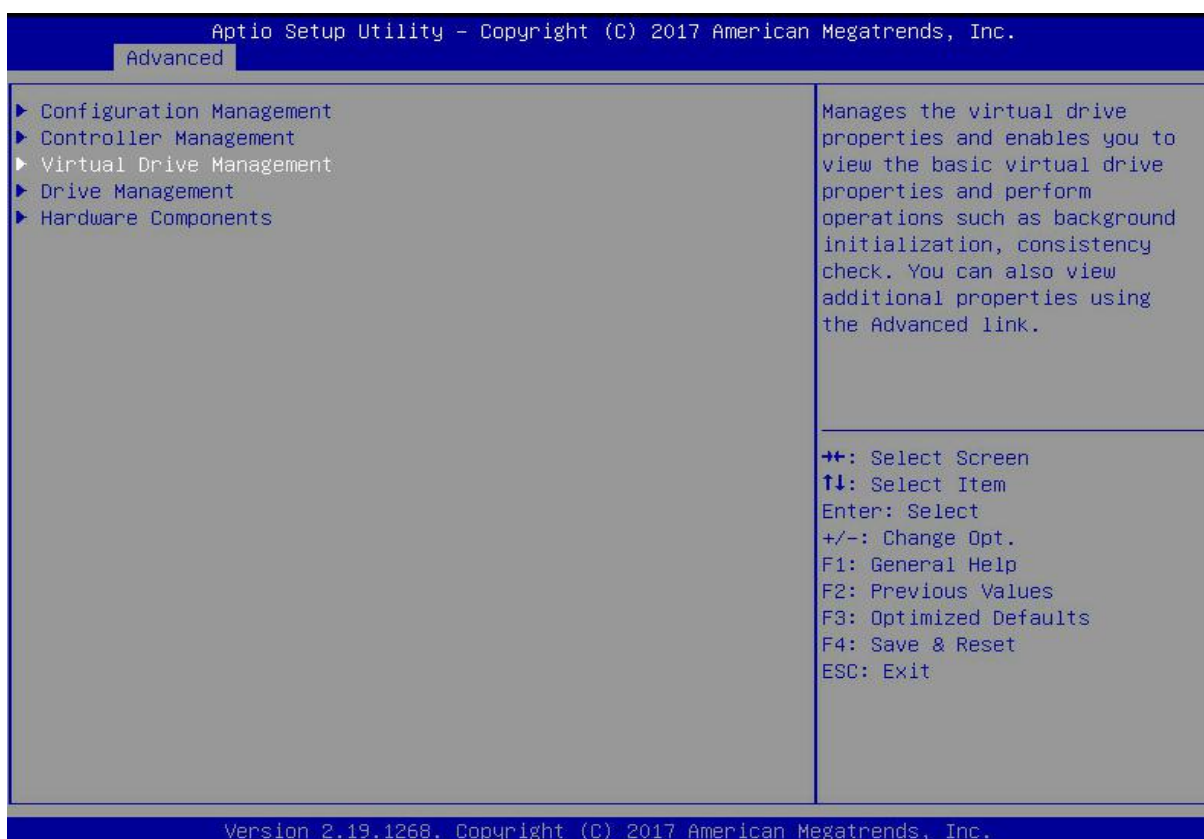

Figure 6- 49

The interface shown in Figure 6-50 is displayed, select the logical disk to be deleted, and press Enter.

Figure 6-50 Logical disk management interface

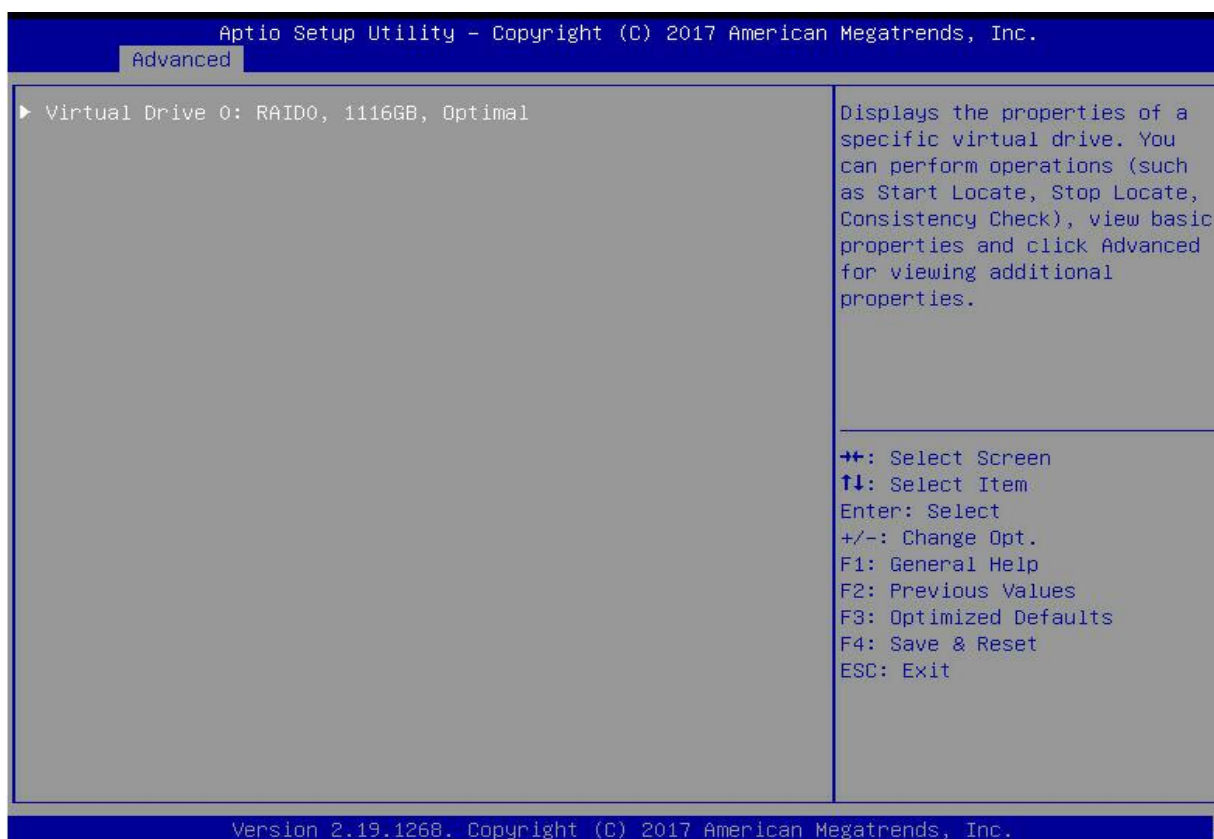

Figure 6- 50

On the interface shown in Figure 6-51, select Operation and press Enter. In the displayed dialog box, select Delete Virtual Drive and press Enter.

Figure 6-51 Operation interface

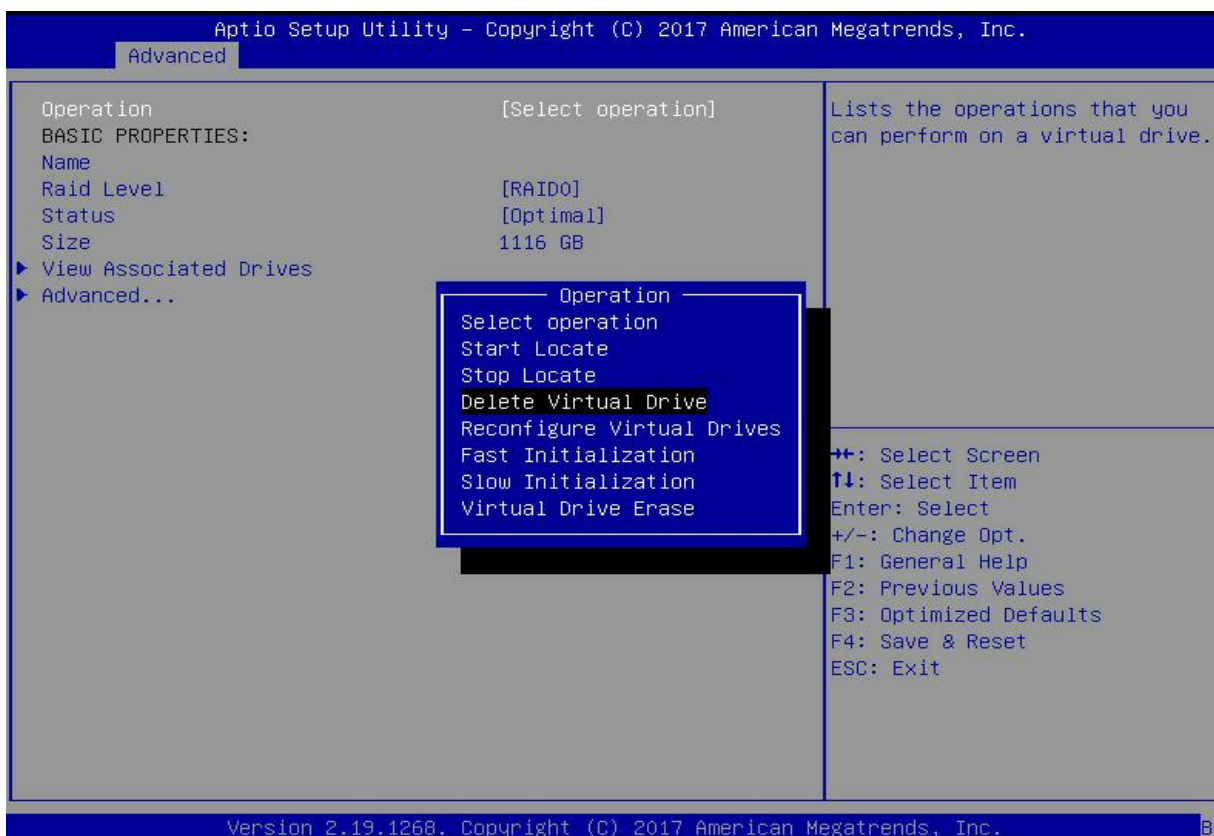

Figure 6-51

Enter the interface shown in Figure 6-52, select Go, and press Enter.

Figure 6-52 Select Go

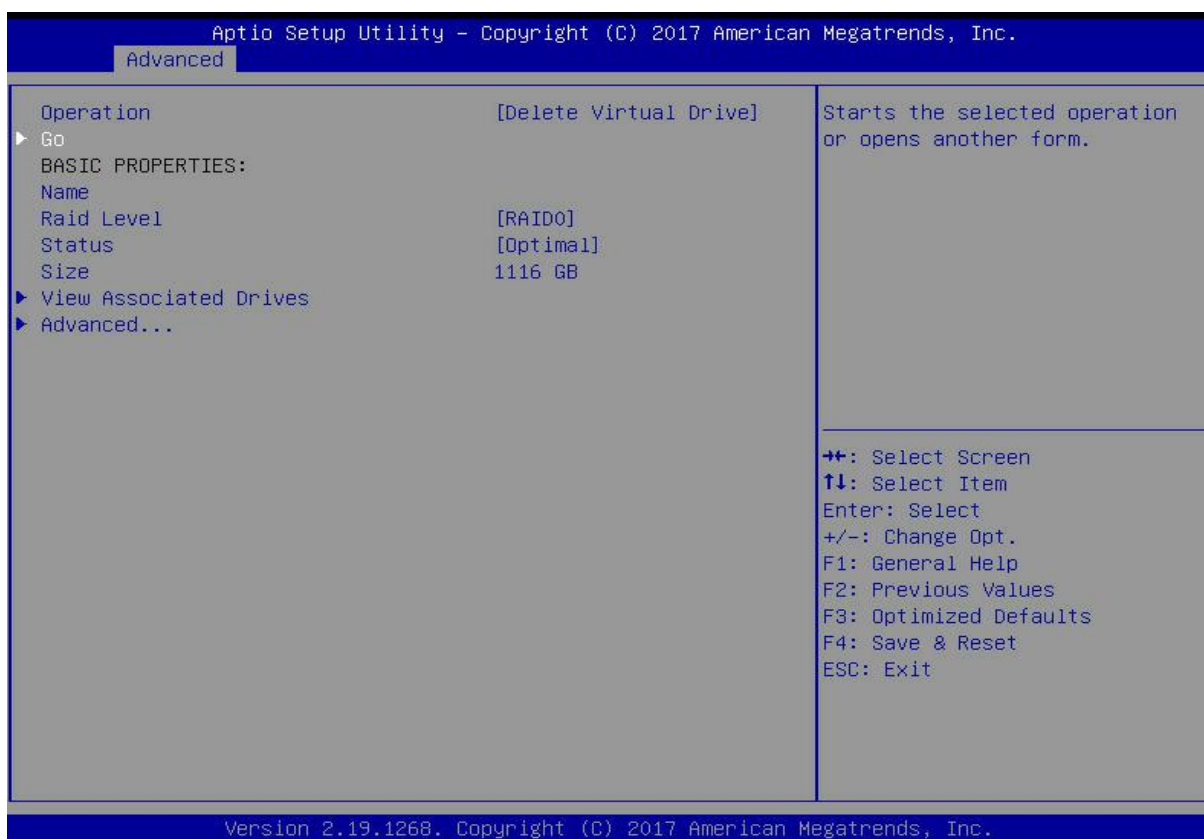

Figure 6-52

Enter the interface shown in Figure 6-53, select Confirm to enable it, select Yes, and press Enter.

Figure 6-53 Confirm deletion



Figure 6-53

The interface shown in Figure 6-54 is displayed, and the RAID deletion operation is completed.

Figure 6-54 Complete the deletion of RAID



Figure 6-54

Locate disk location:

Locate physical disks

As shown in Figure 6-55, select Drive Management on the RAID card configuration interface, and press Enter.

Figure 6-55 Select Drive Management

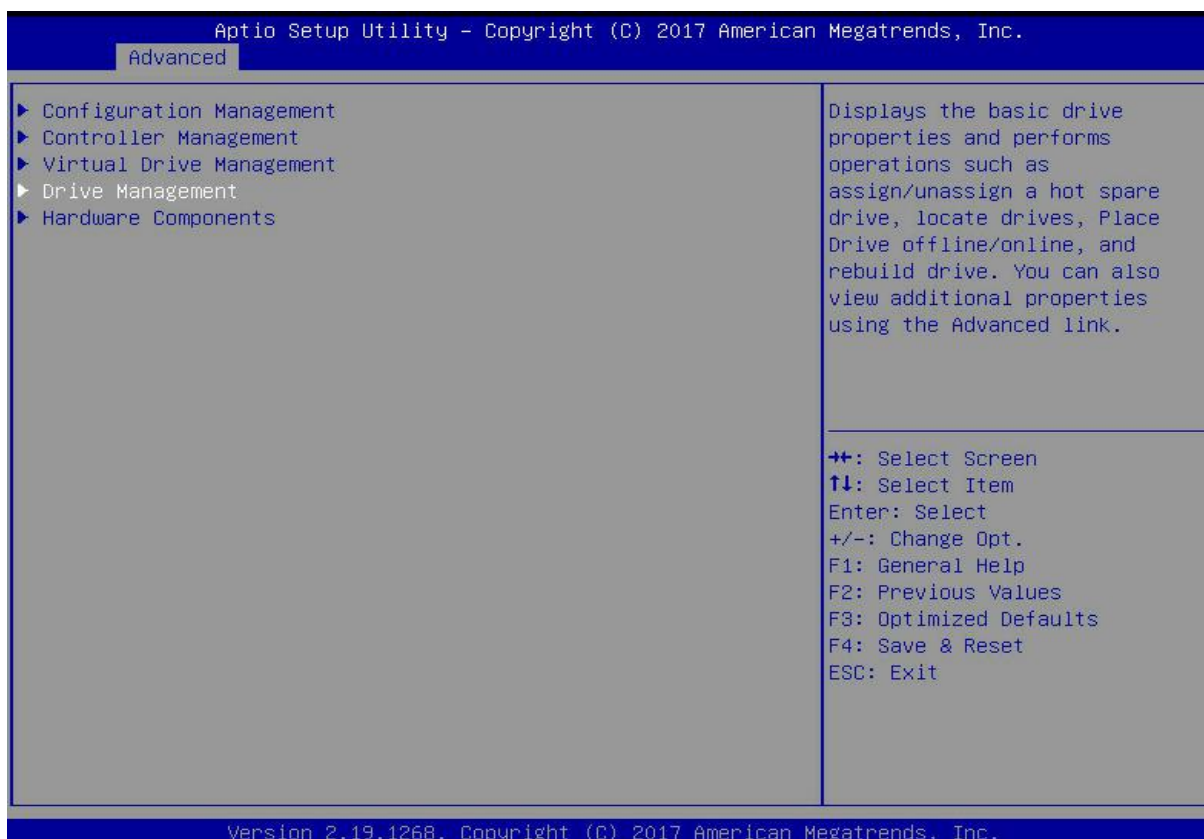

Figure 6-55

On the interface shown in Figure 6-56, select the disk to be located, and press Enter.

Figure 6-56 Select the disk to be located

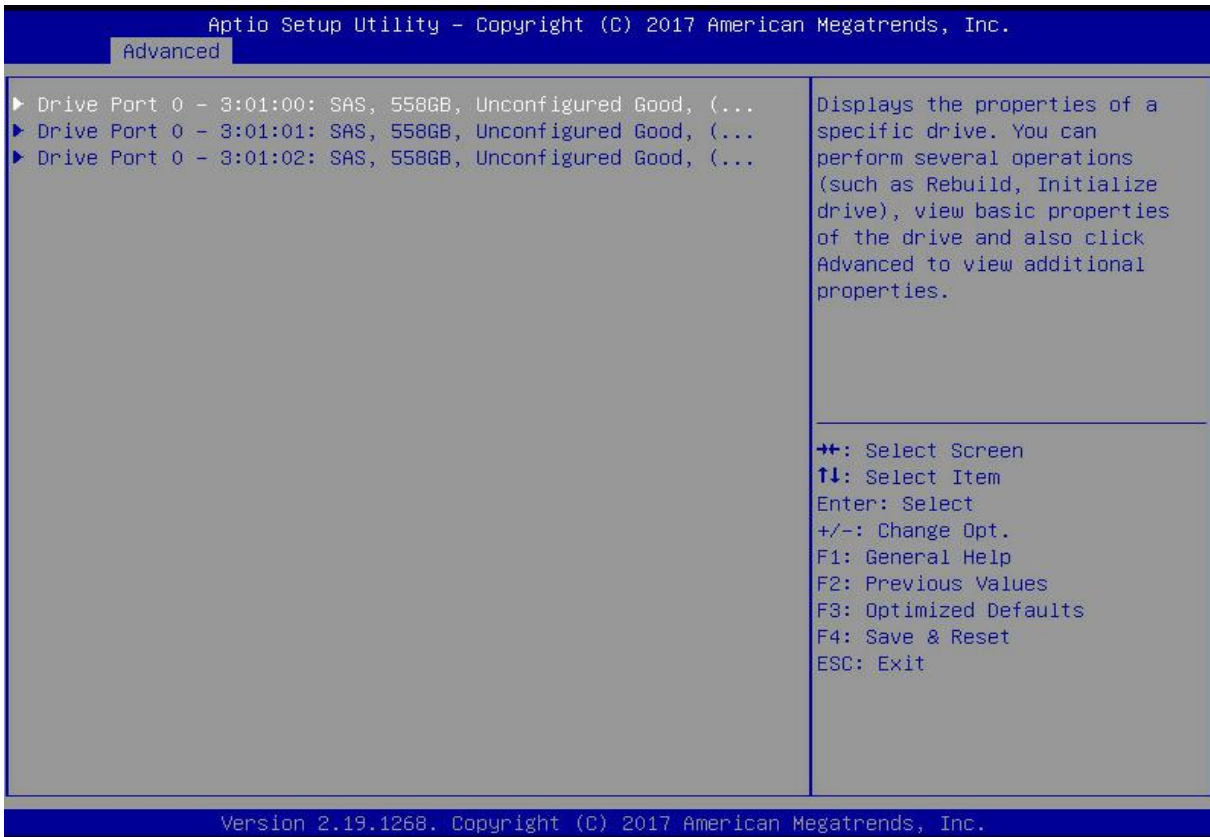

Figure 6-56

On the interface shown in Figure 6-57, select Operation, and press Enter. In the displayed dialog box, select Start Locate and press Enter.

Figure 6-57 Operation interface

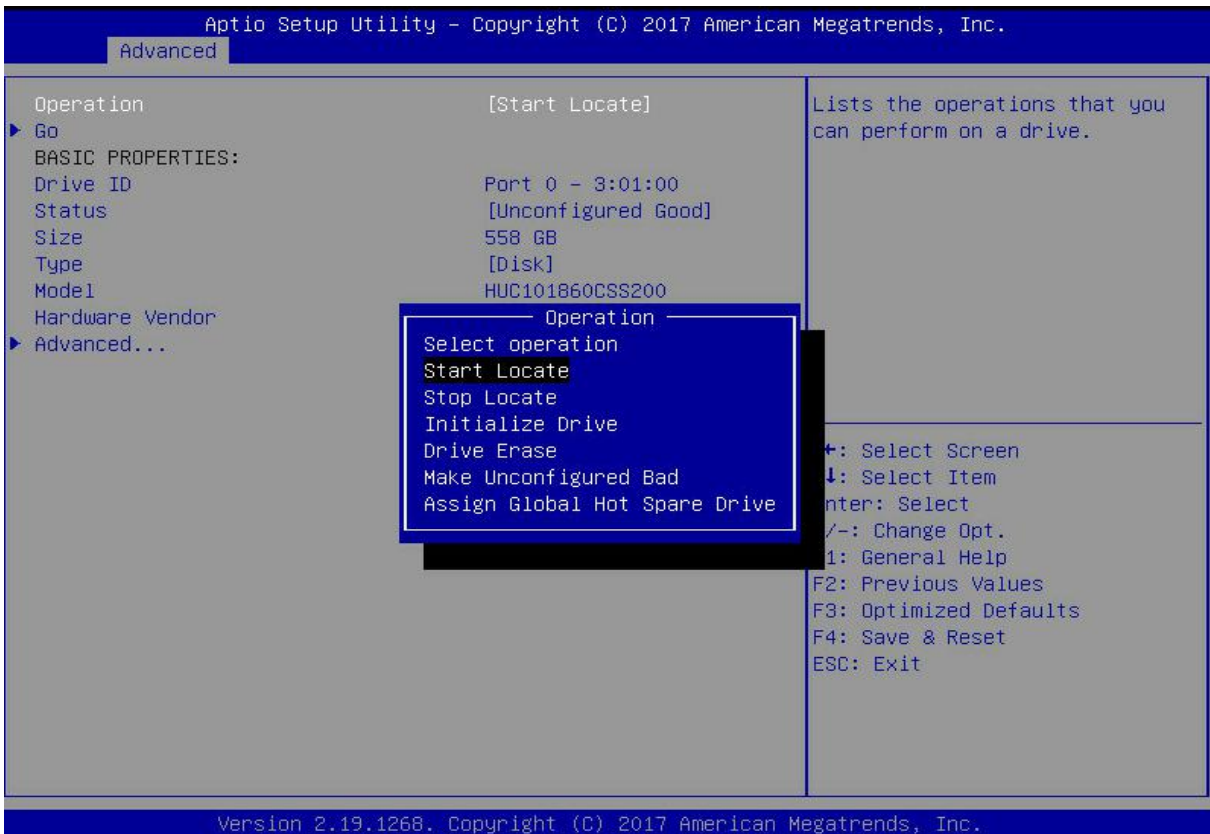

Figure 6-57

Enter the interface shown in Figure 6-58, select Go, and press Enter.

Figure 6-58 Select Go

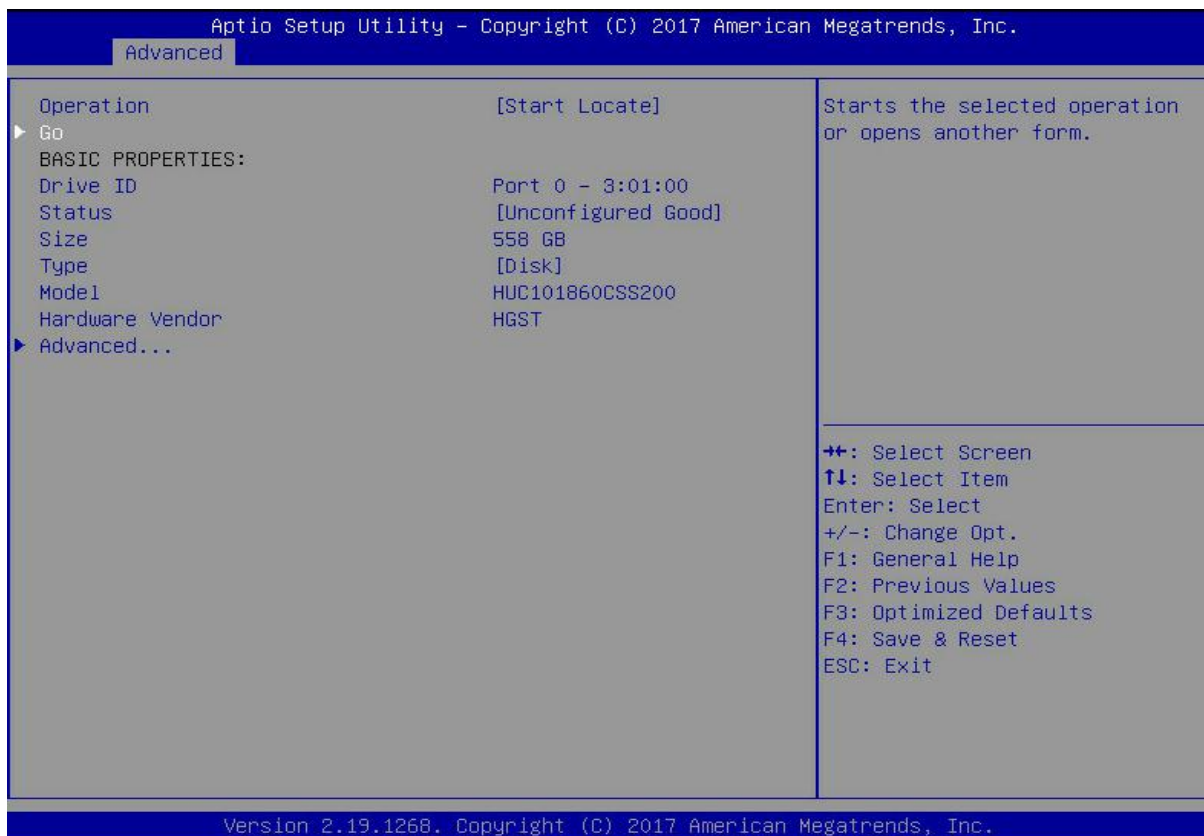

Figure 6-58

Enter the interface shown in Figure 6-59 and complete the operation of locating the physical disk.

Figure 6-59 Complete physical disk location positioning

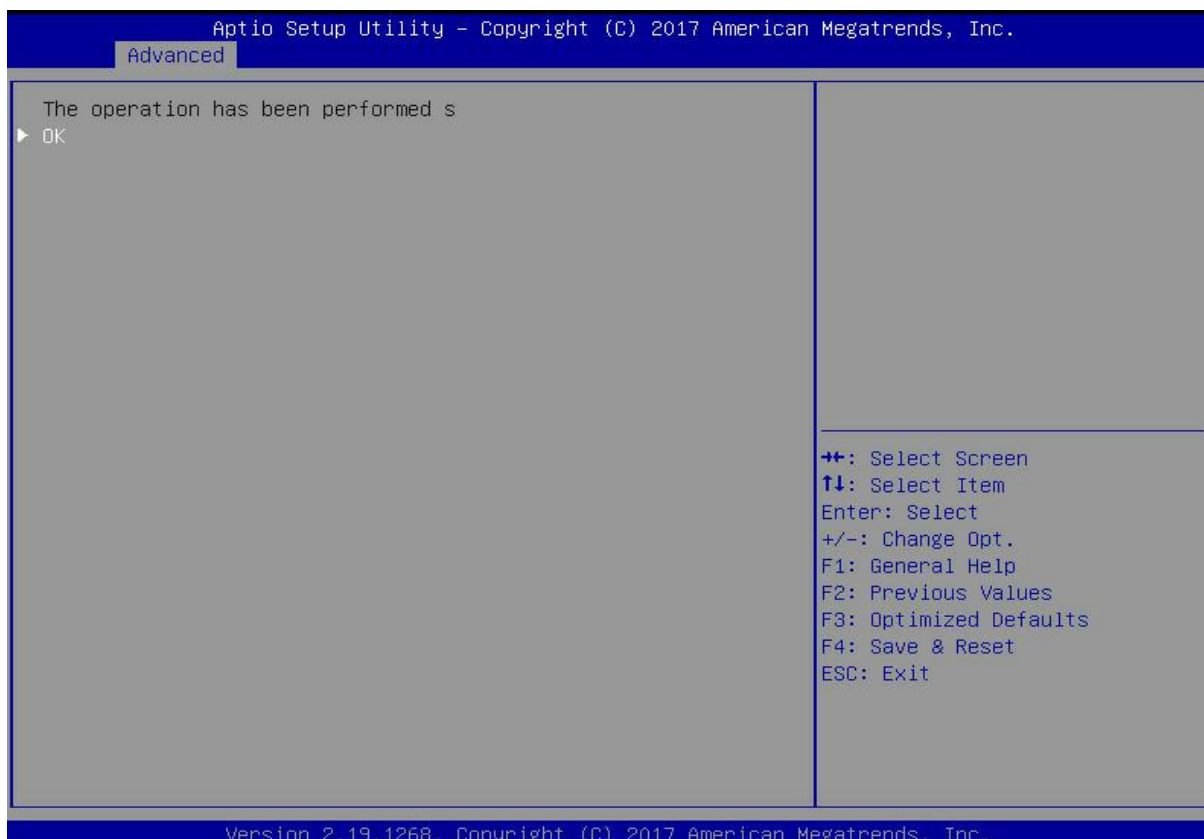

Figure 6-59

Locate all disks in a logical disk

As shown in Figure 6-60, select Virtual Drive Management on the RAID card configuration interface, and press Enter.

Figure 6-60 RAID card configuration interface

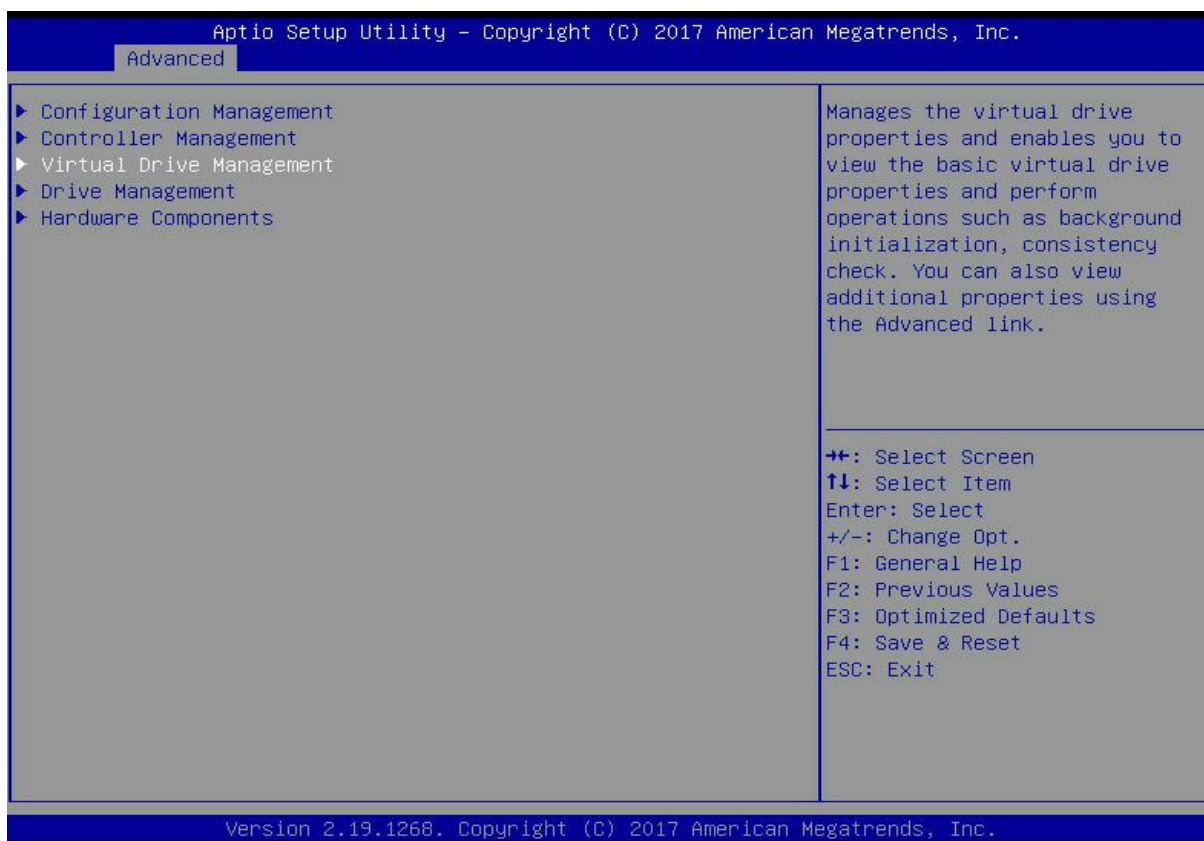

Figure 6- 60

On the interface shown in Figure 6-61, select the logical disk to be located, and press Enter.

Figure 6-61 Selecting the logical disk to be located

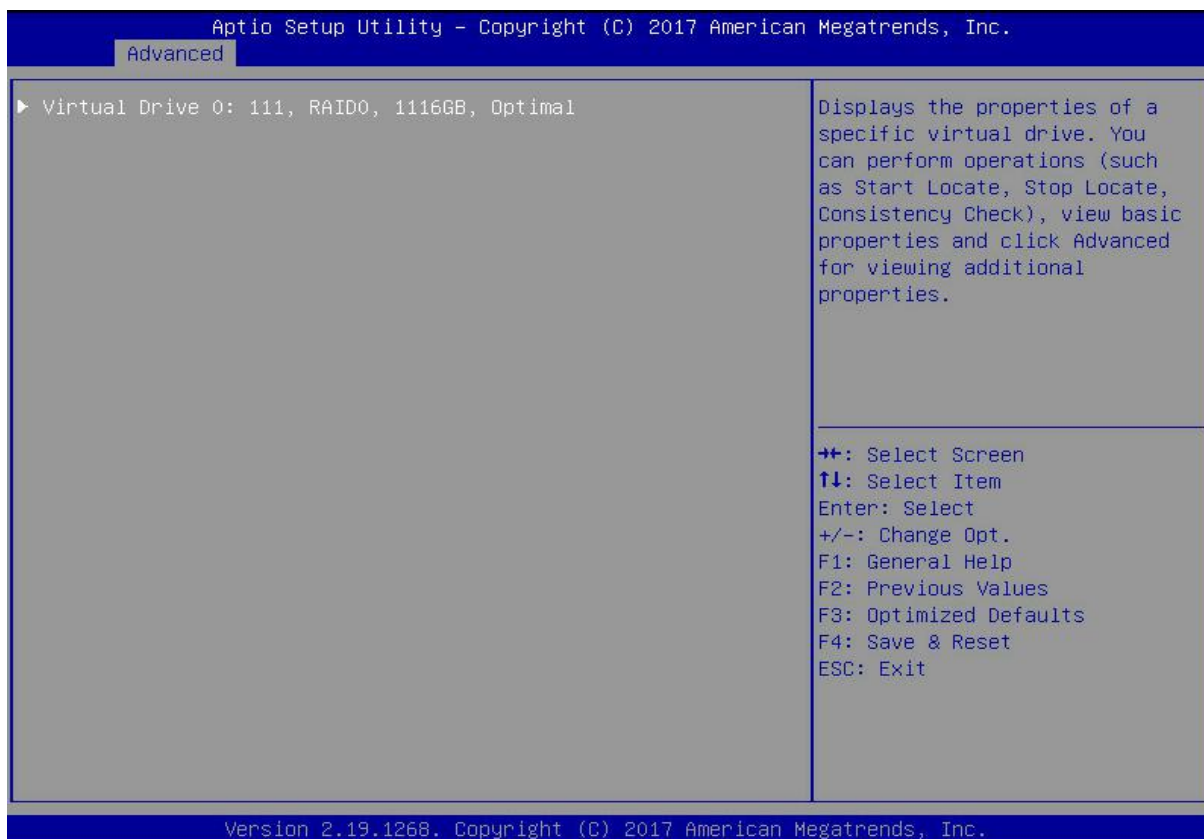

Figure 6-61

On the interface shown in Figure 6-62, select Operation and press Enter. In the displayed dialog box, select Start Locate and press Enter.

Figure 6-62 Operation interface

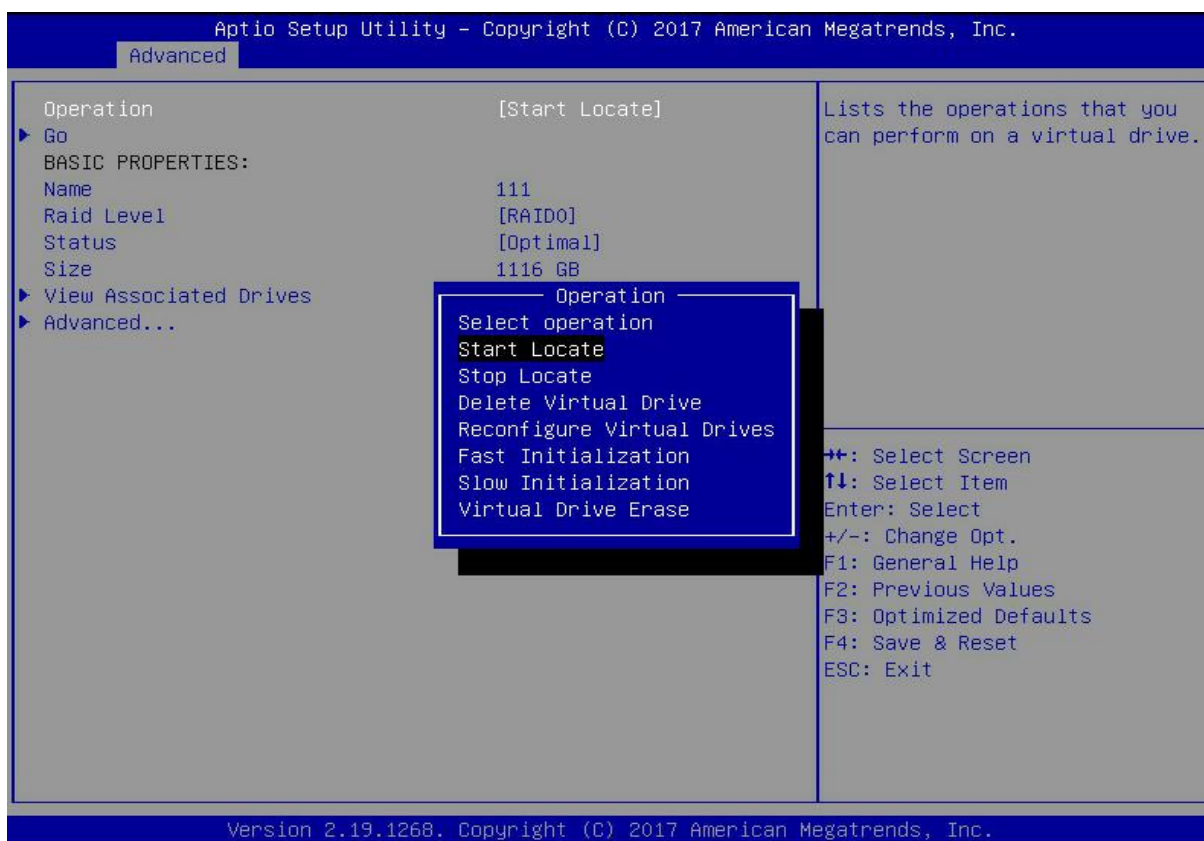

Figure 6-62

Enter the interface shown in Figure 6-63, select Go, and press Enter.

Figure 6-63 Select Go

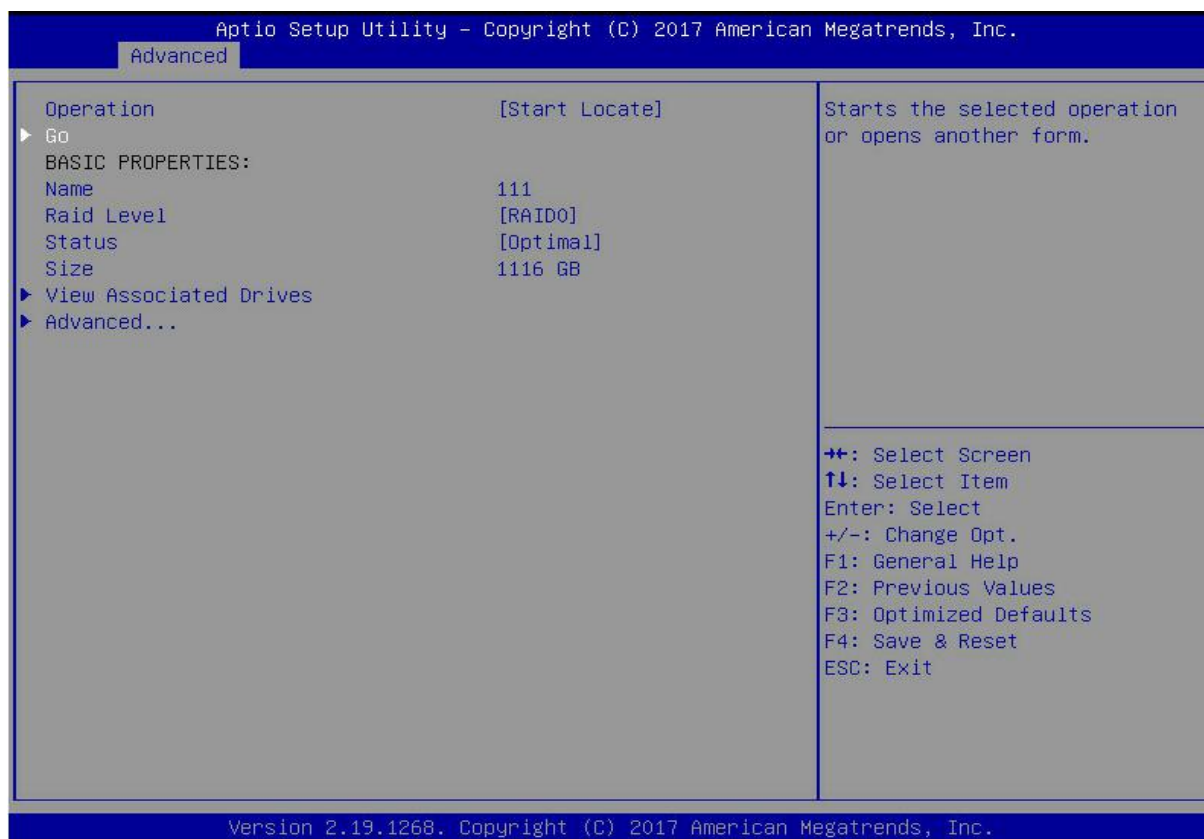

Figure 6- 63

Enter the interface shown in Figure 6-64, and complete the operation of locating all disk locations in the logical disk.

Figure 6-64 Complete the positioning of all disks in the logical disk

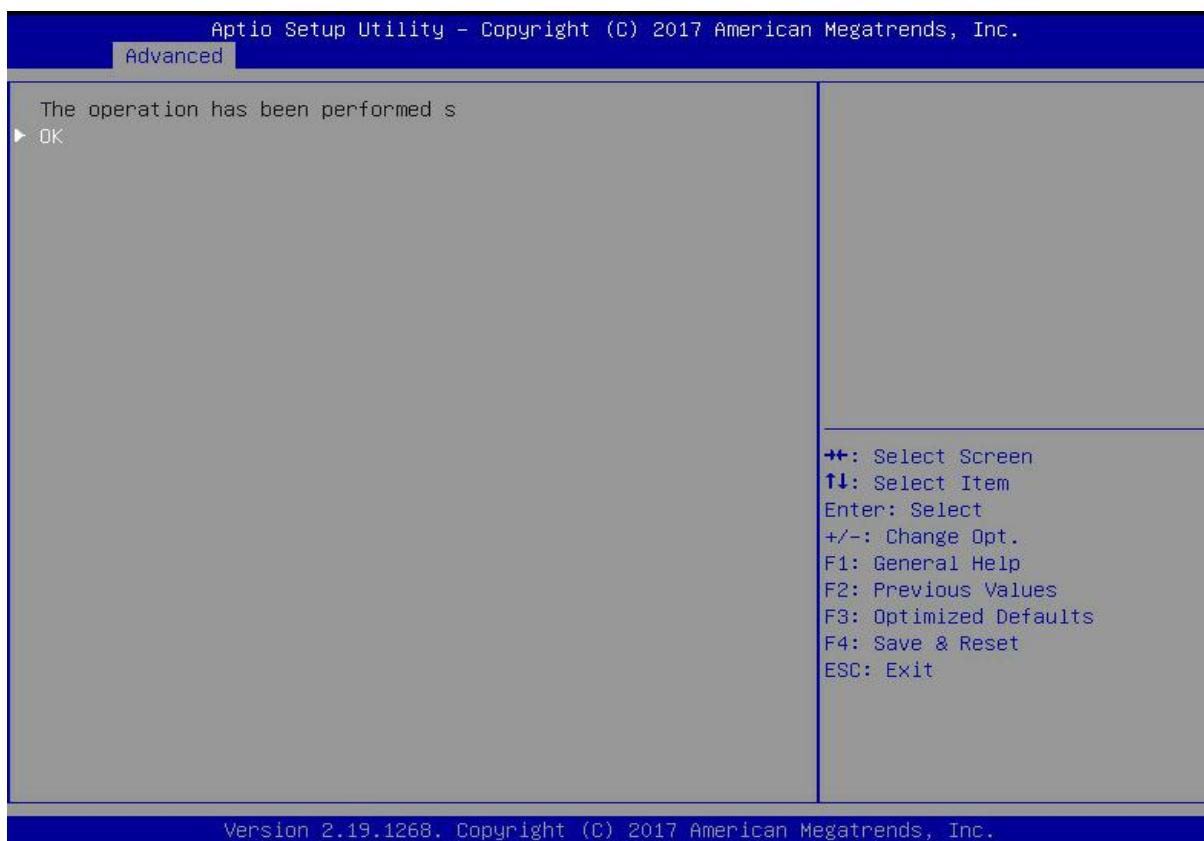

Figure 6- 64

Initialize the logical disk:

This function is used to initialize the internal data space of the logical disk so that it can be recognized and used by the operating system.

As shown in Figure 6-65, select Virtual Drive Management on the RAID card configuration interface, and press Enter.

Figure 6-65 RAID card configuration interface

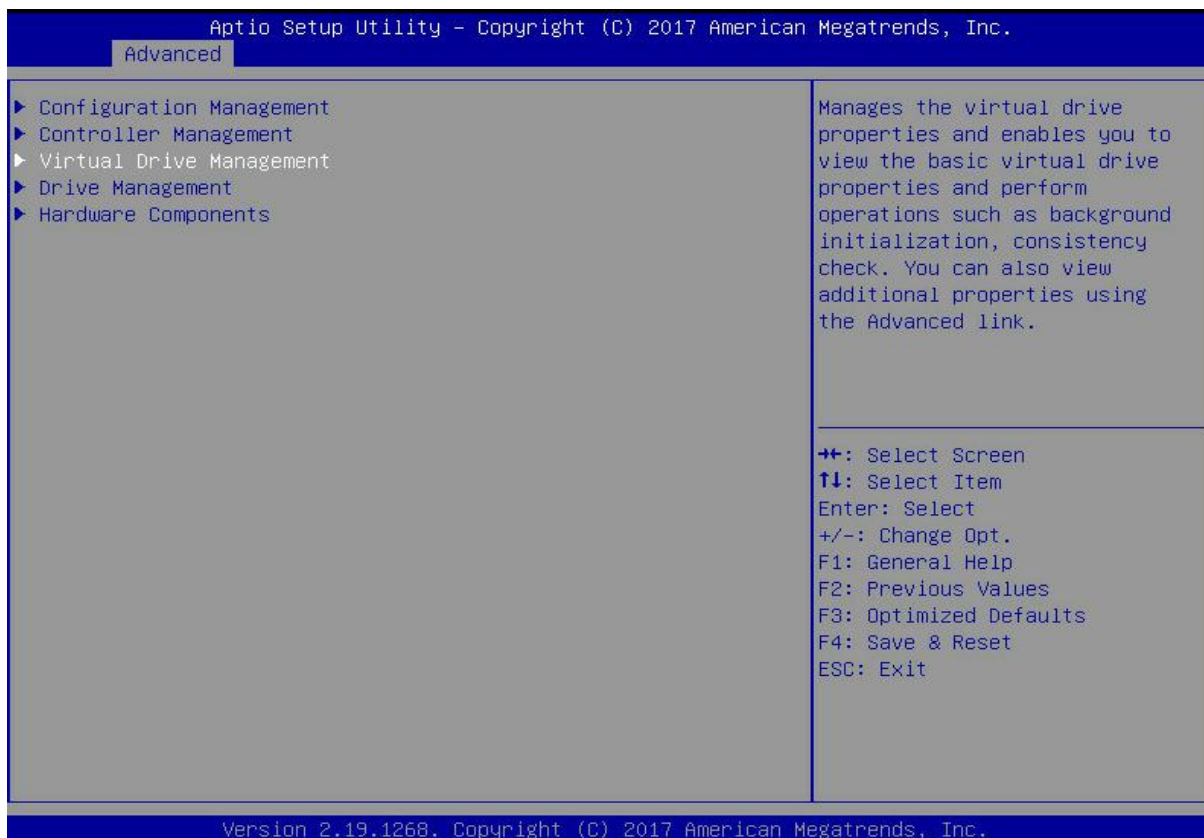

Figure 6- 65

On the interface shown in Figure 6-66, select the logical disk to be initialized, and press Enter.

Figure 6-66 Logical disk management interface

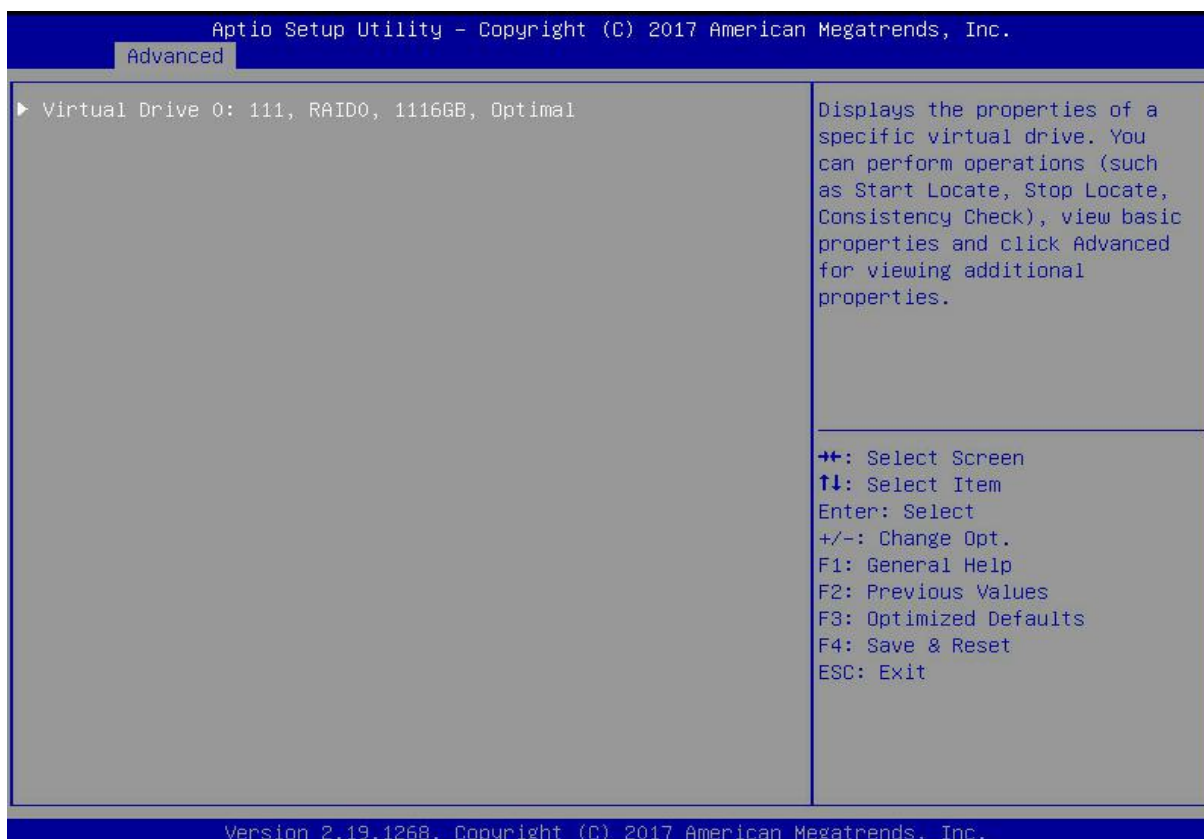

Figure 6- 66

Enter the interface shown in Figure 6-67, select Operation, and press Enter. In the dialog box that pops up, select Fast/Slow Initialization and press Enter.

Figure 6-67 Operation interface

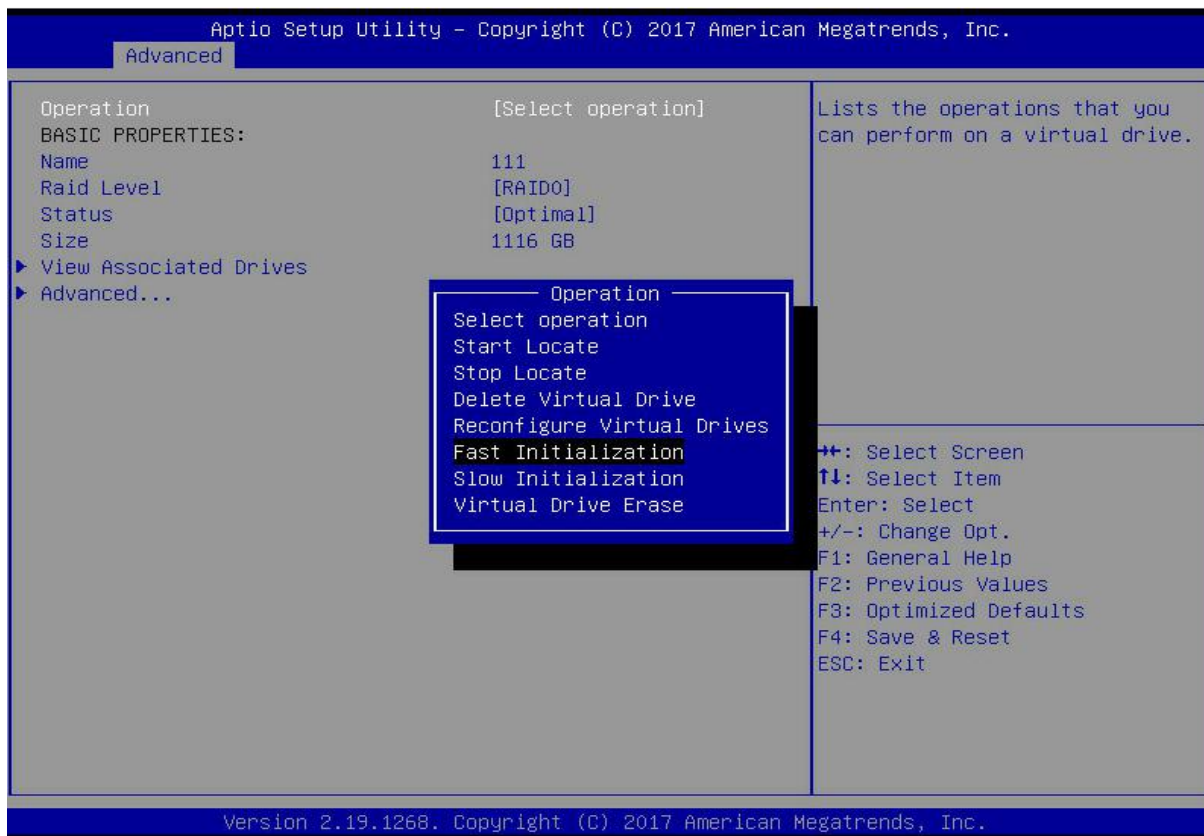

Figure 6- 67

The difference between Fast Initialization and Slow Initialization is that the former can write data immediately, while the latter needs to wait for all the disk space to be initialized before writing data.

Enter the interface shown in Figure 6-68, select Go, and press Enter.

Figure 6-68 Select Go

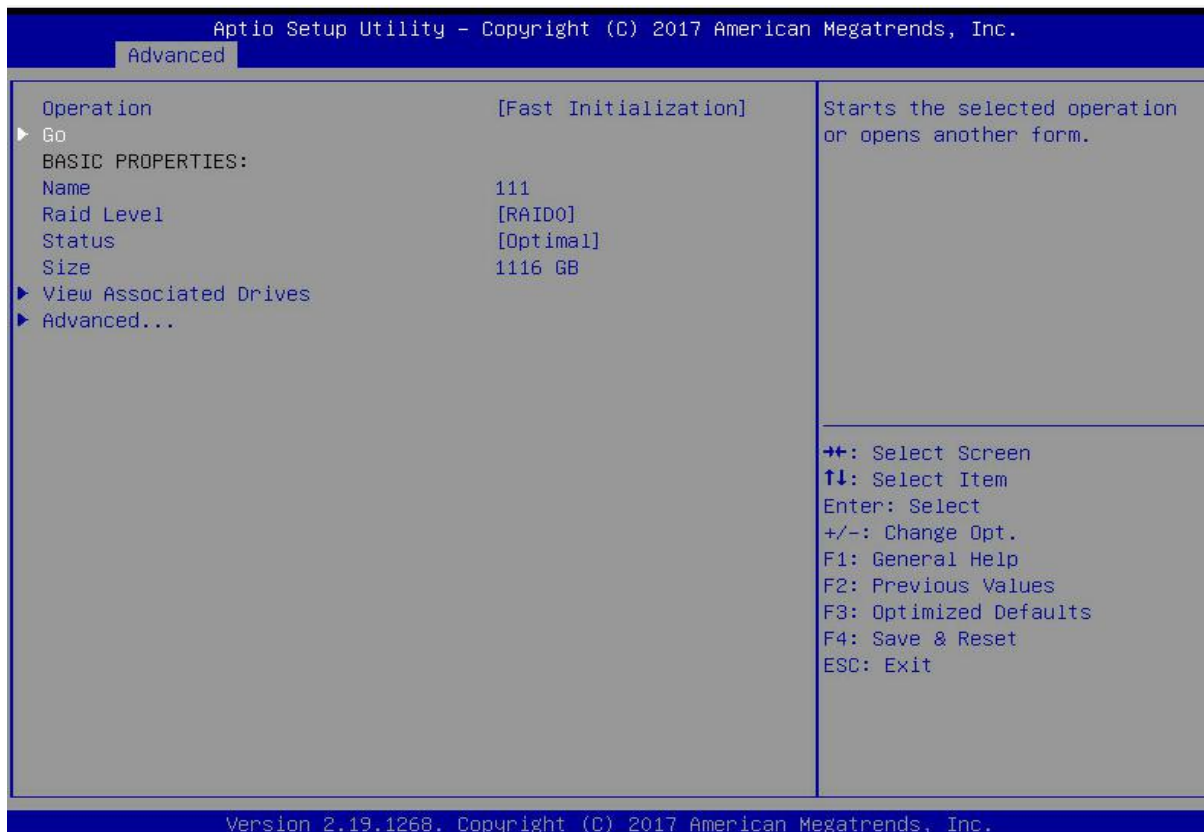

Figure 6- 68

Enter the interface shown in Figure 6-69, select Confirm to enable it, select Yes, and press Enter. Figure 6-69 Confirm initialization

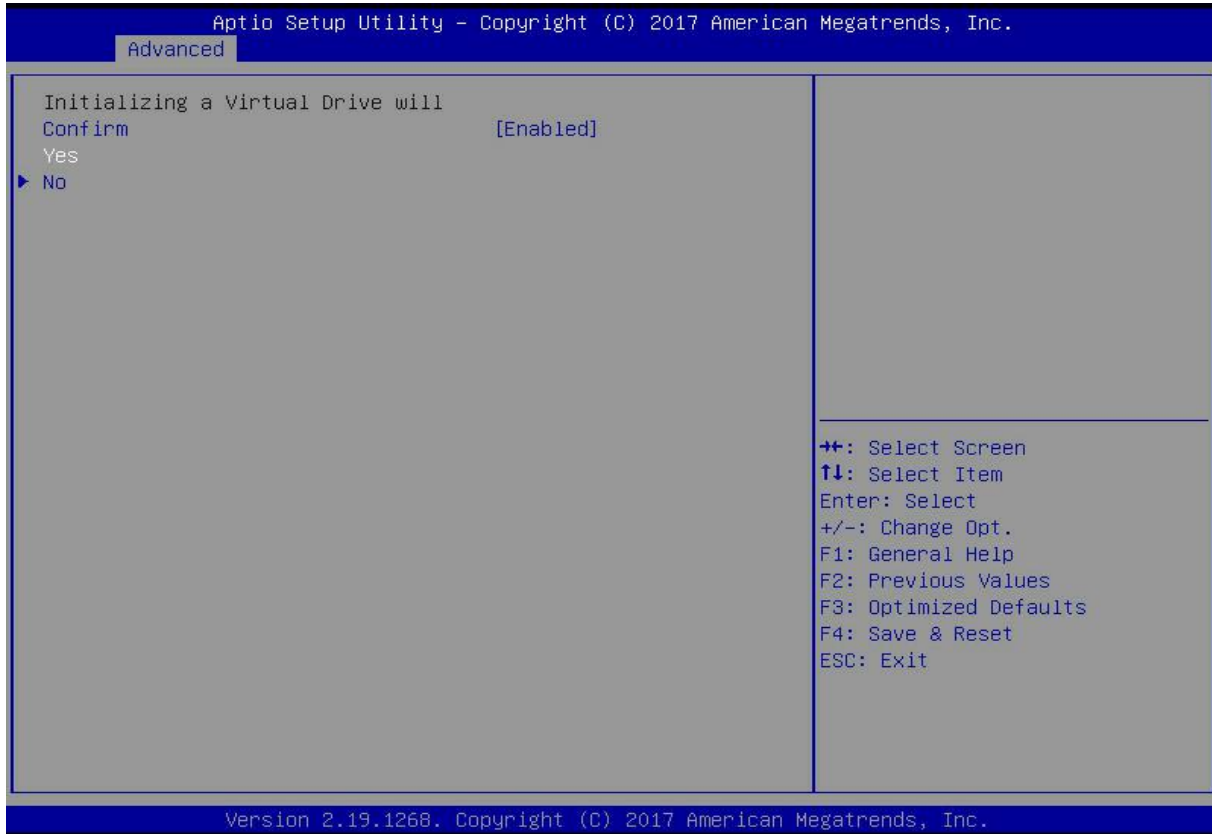

Figure 6- 69

Enter the interface shown in Figure 6-70 to complete the initialization of the logical disk.

Figure 6-70 Complete the initialization of the logical disk

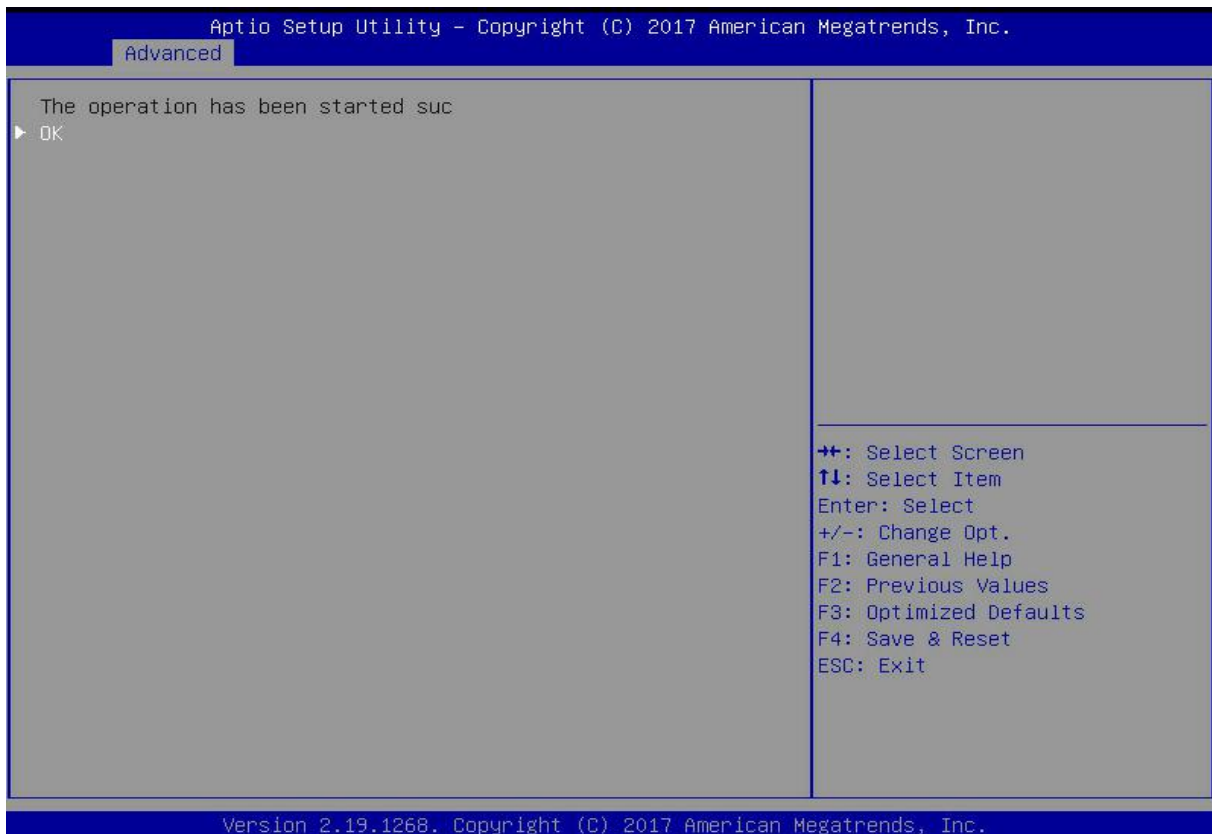

Figure 6- 70

Initialize the physical disk:

As shown in Figure 6-71, select Drive Management on the RAID card configuration interface, and press Enter.

Figure 6-71 RAID card configuration interface

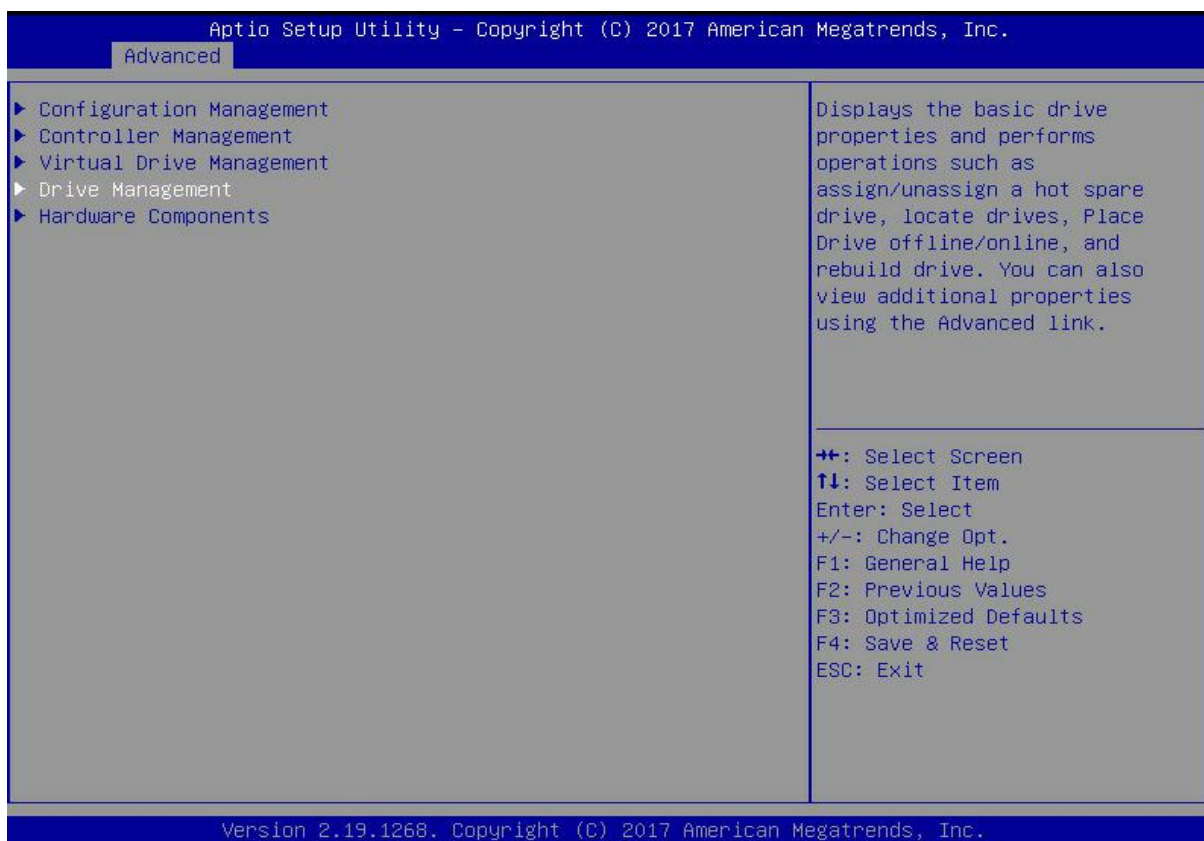

Figure 6- 71

Enter the interface shown in Figure 6-72, select the disk to be initialized, and press Enter.

Figure 6-72 Disk management interface

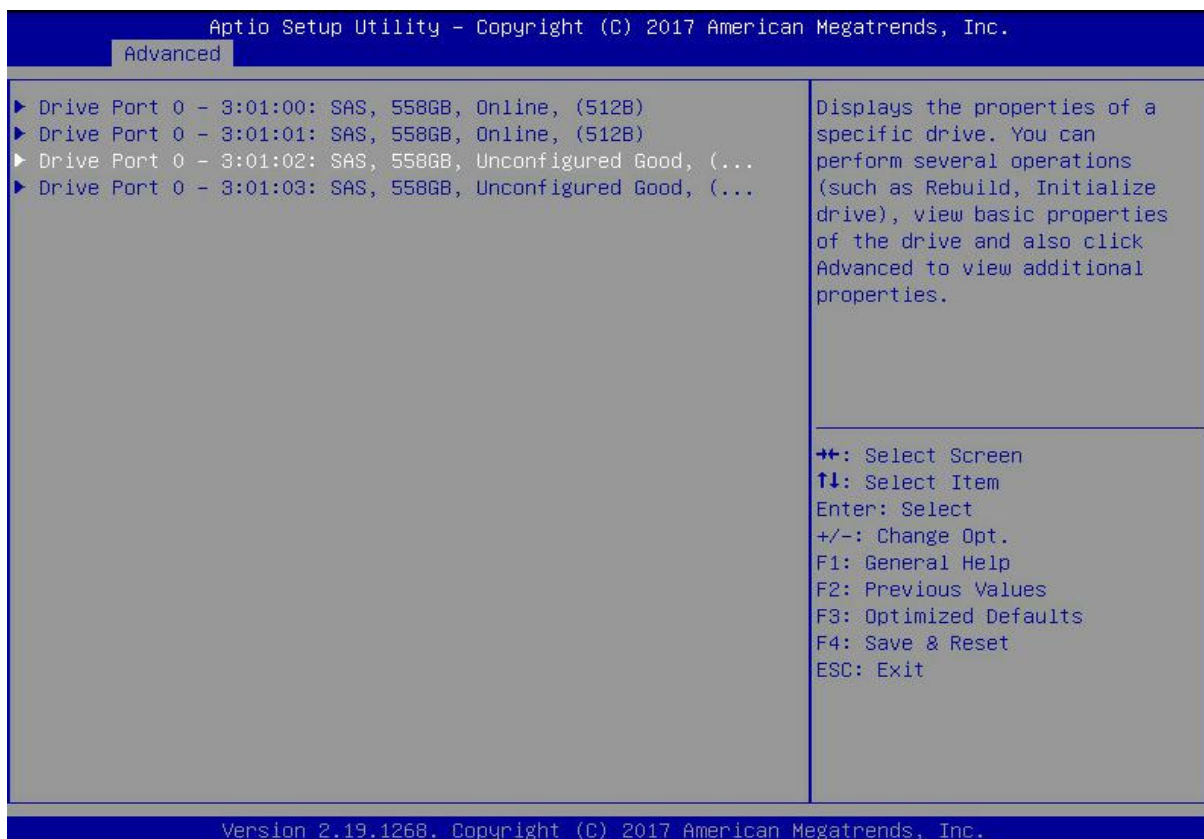

Figure 6- 72

On the interface shown in Figure 6-73, select Operation, and press Enter. In the displayed dialog box, select Initialize Drive and press Enter.

Figure 6-73 Operation management interface

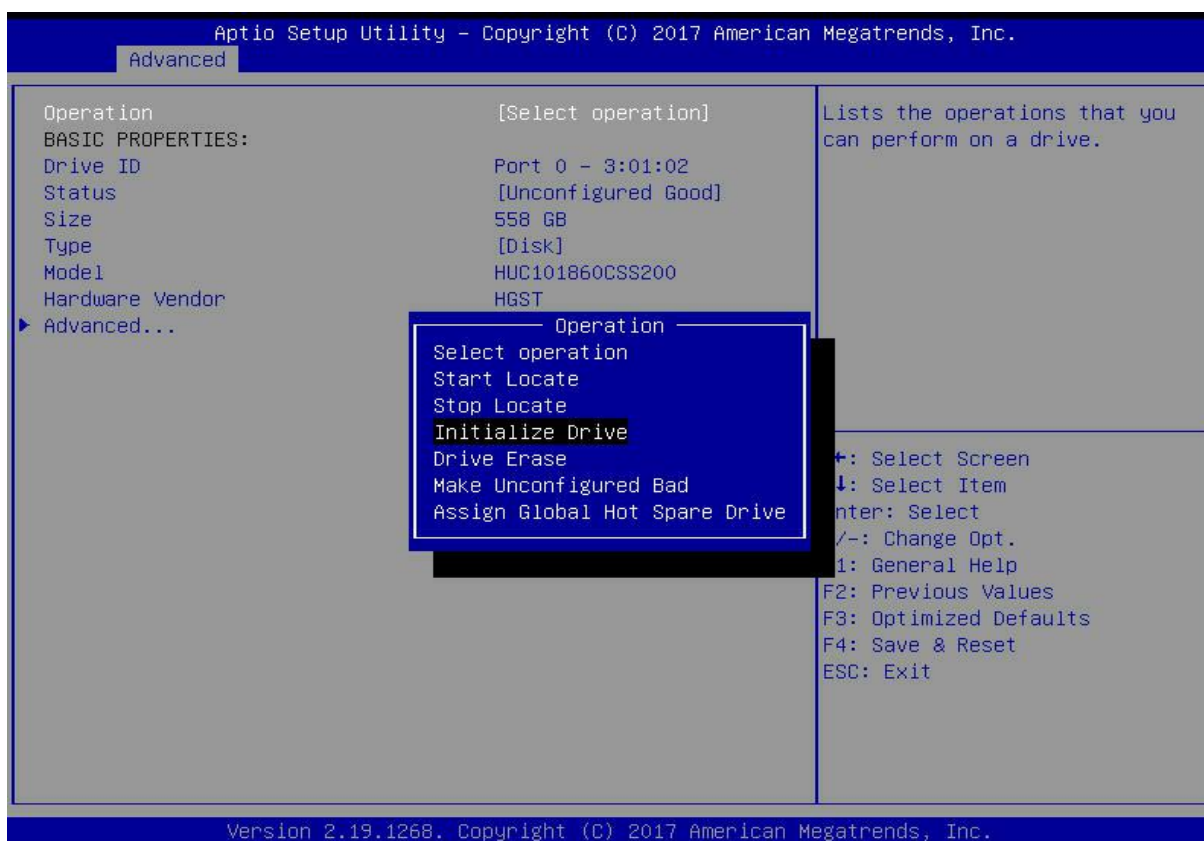

Figure 6- 73

Enter the interface shown in Figure 6-74, select Go, and press Enter.

Figure 6-74 Select Go

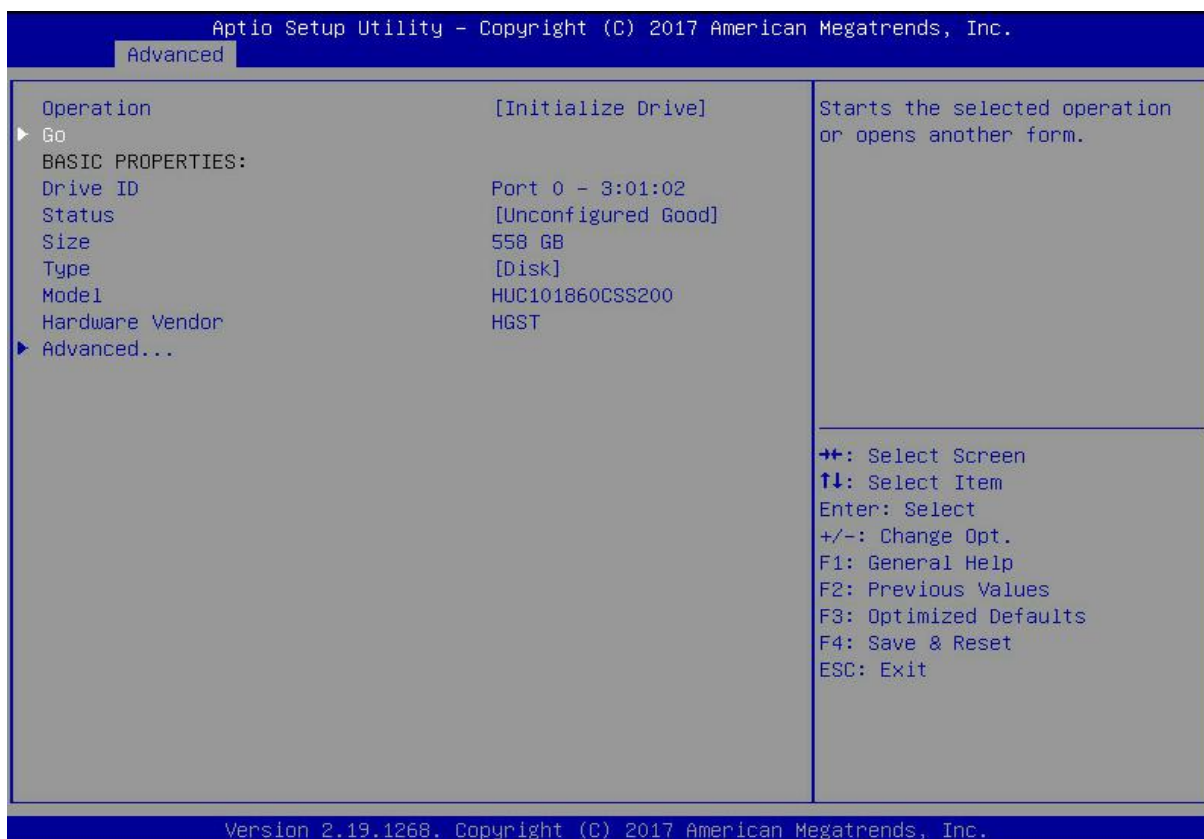

Figure 6- 74

Enter the interface shown in Figure 6-75, select Confirm to enable it, select Yes, and press Enter.

Figure 6-75 Confirm initialization

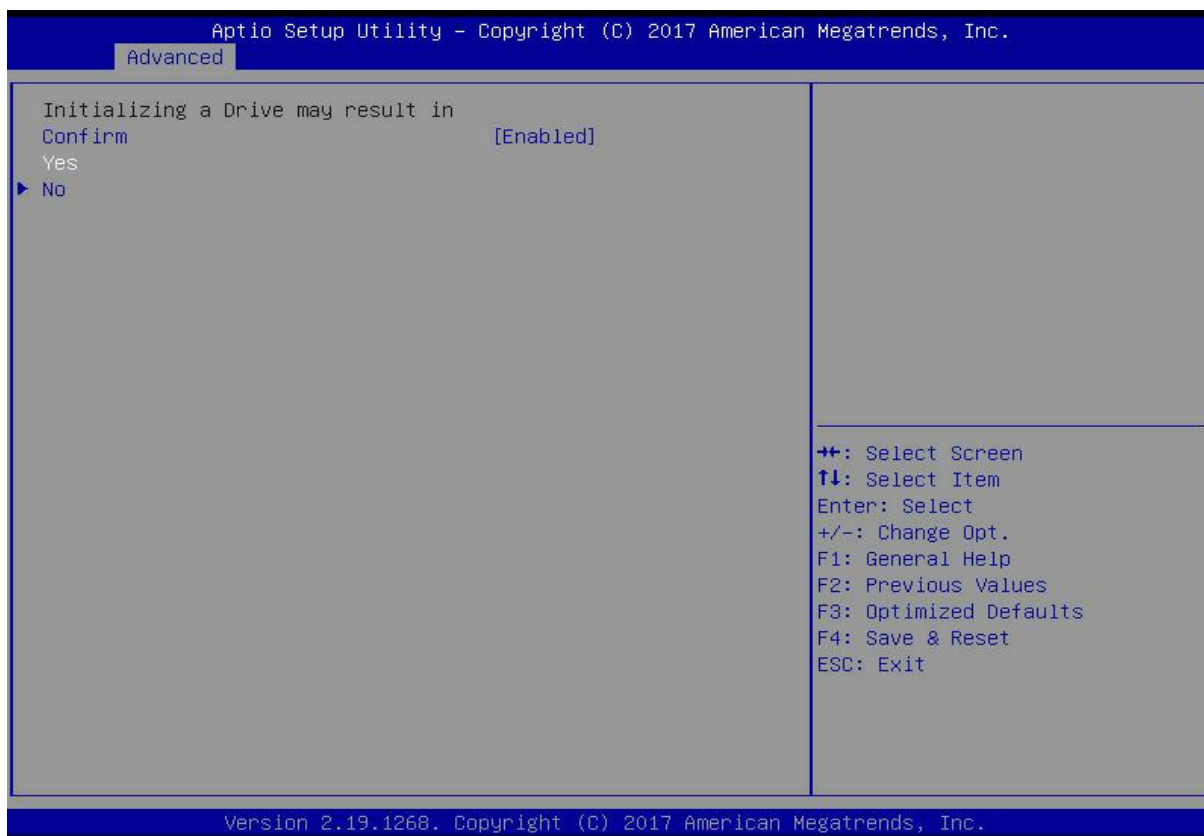

Figure 6- 75

Enter the interface shown in Figure 6-76 to complete the initialization of the physical disk.

Figure 6-76 Complete the initialization of the physical disk

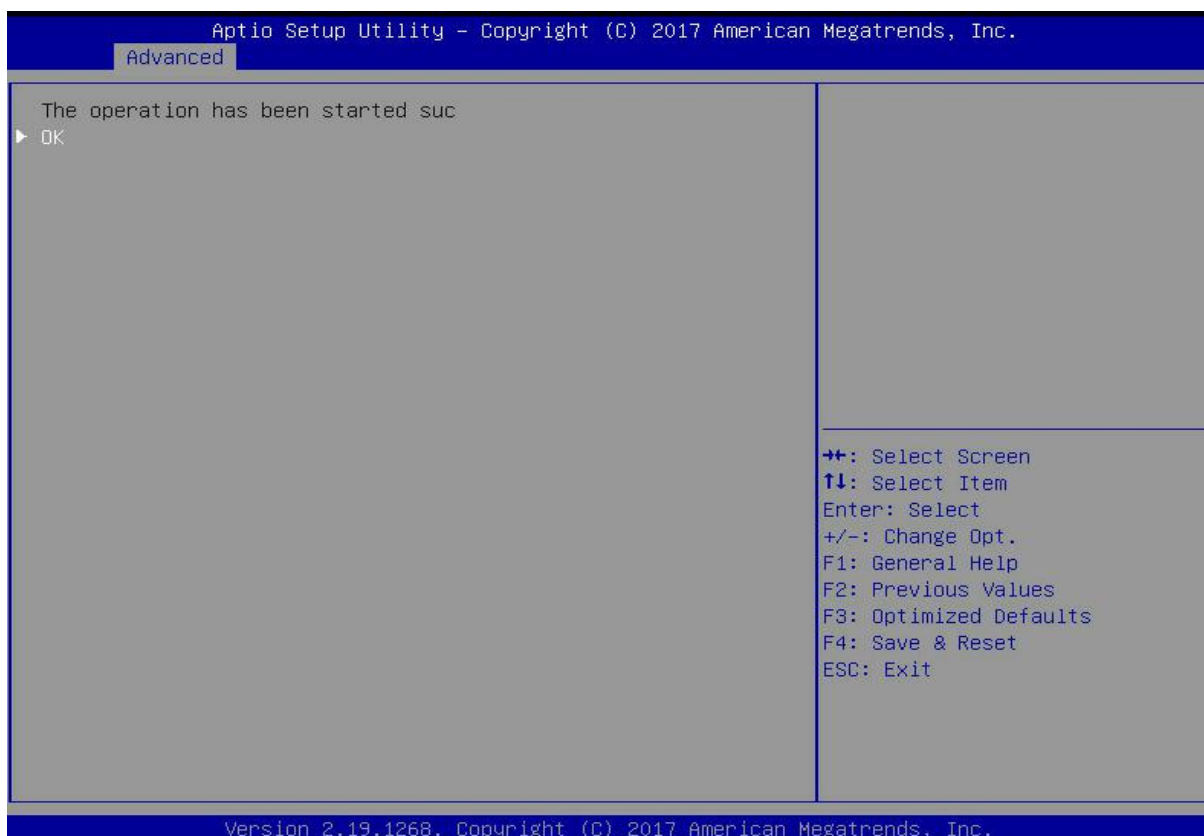

Figure 6- 76

Erase disk data:

This function is used to delete data inside the disk, including erasing physical disk data and logical disk data.

Erase physical disk data

As shown in Figure 6-77, select Drive Management on the RAID card configuration interface, and press Enter.

Figure 6-77 RAID card configuration interface

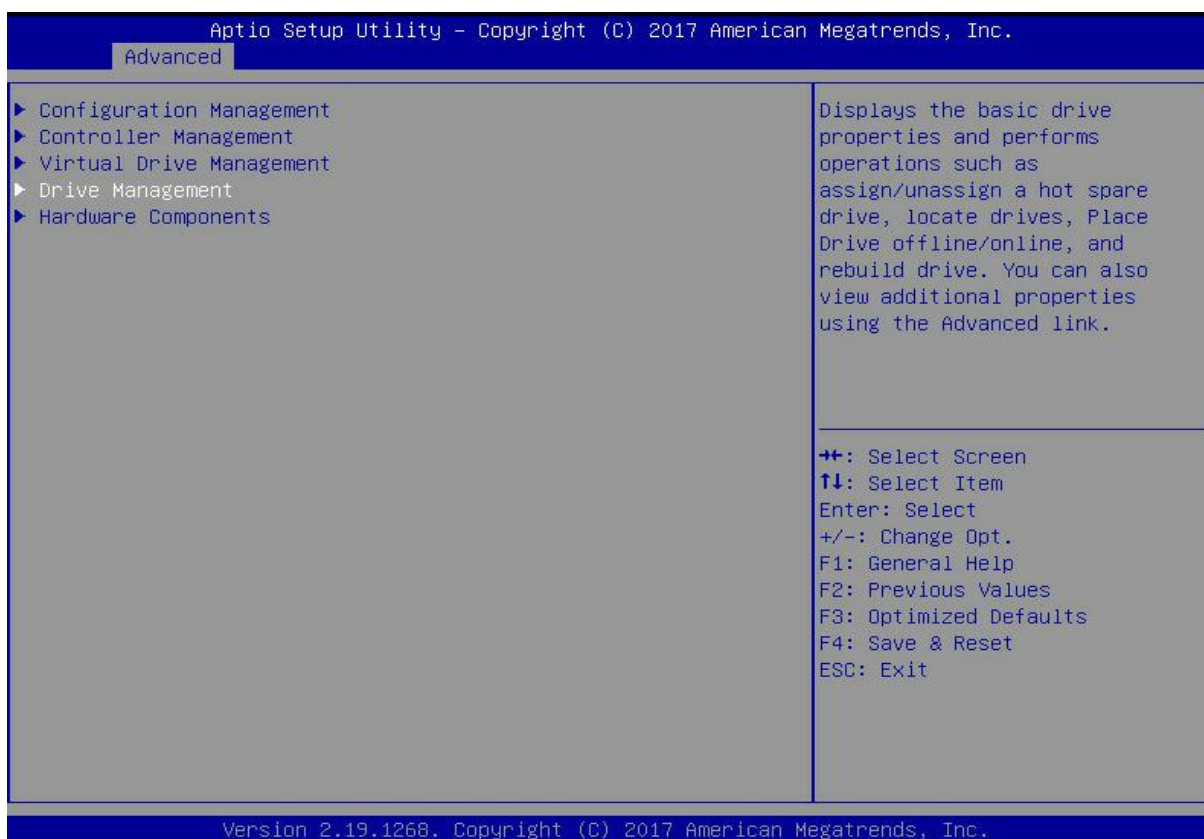

Figure 6- 77

The interface shown in Figure 6-78 is displayed, select the disk whose data is to be erased, and press Enter.

Figure 6-78 Disk management interface

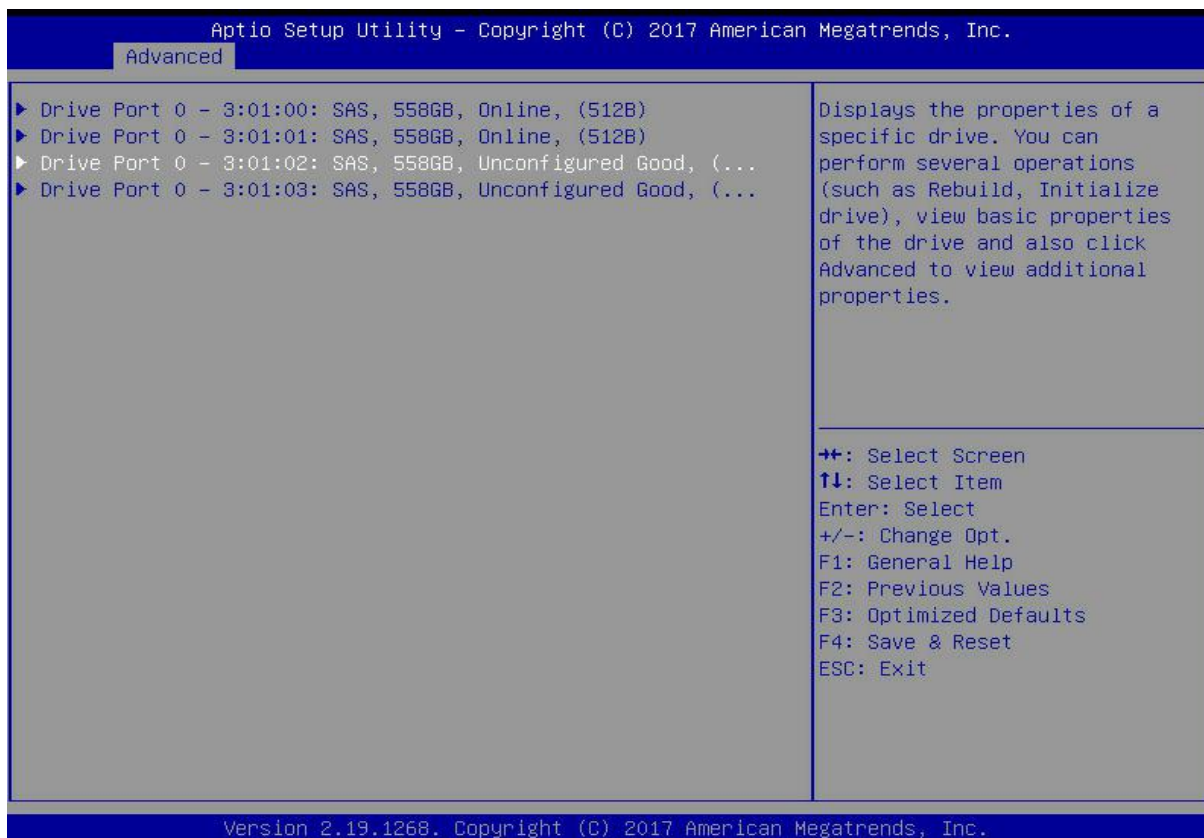

Figure 6- 78

Enter the interface shown in Figure 6-79, select Operation, press Enter, then select Drive Erase in the displayed dialog box, and press Enter.

Figure 6-79 Operation interface

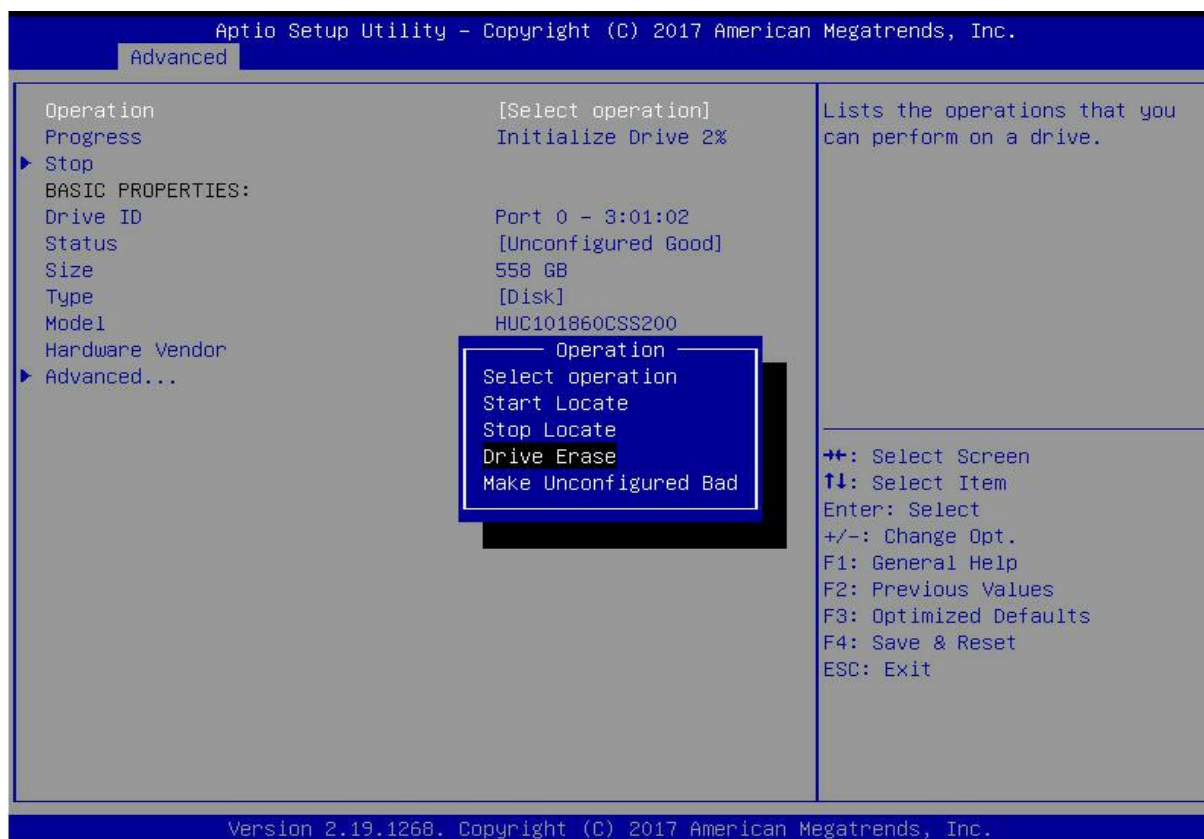

Figure 6- 79

Enter the interface shown in Figure 6-80, press Enter, and then select the erase mode in the pop-up dialog box (the default mode is recommended: Simple).

Figure 6-80 Erase Mode interface

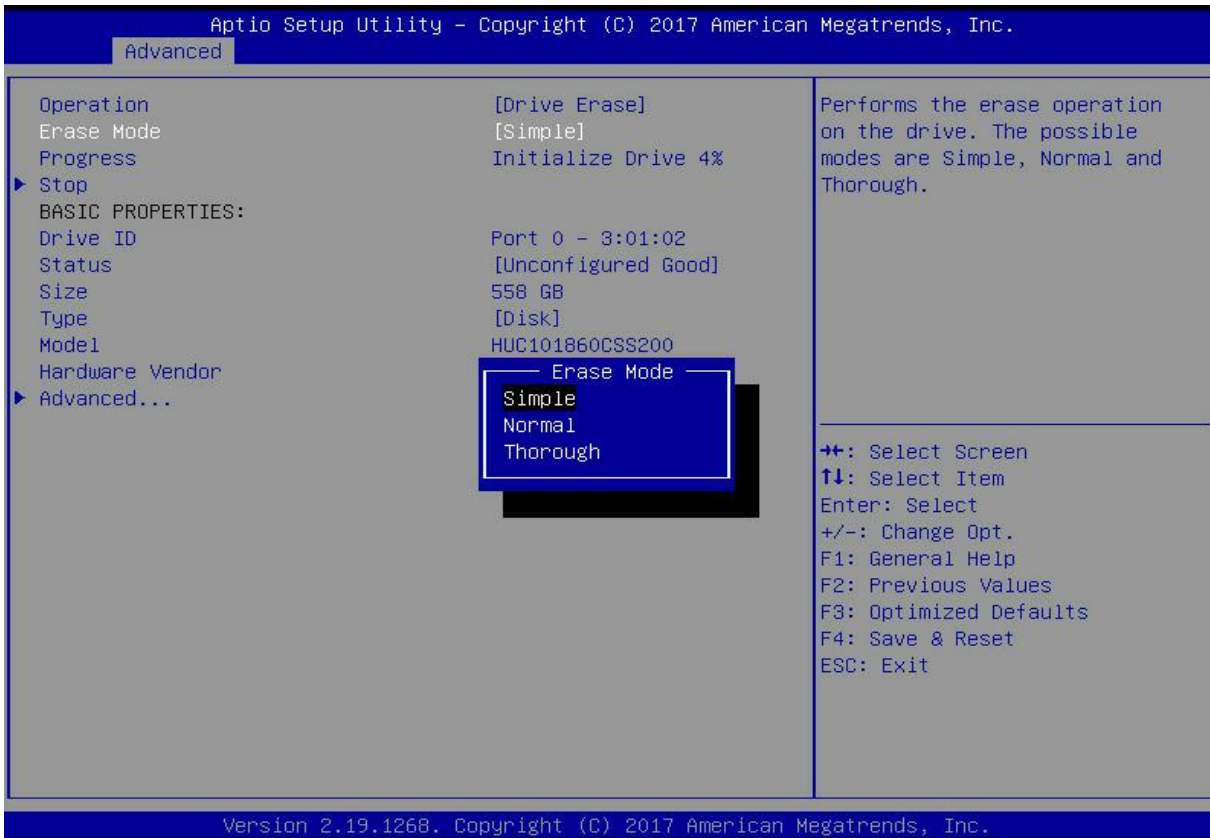

Figure 6- 80

Enter the interface shown in Figure 6-81, select Go, and press Enter.

Figure 6-81 Select Go

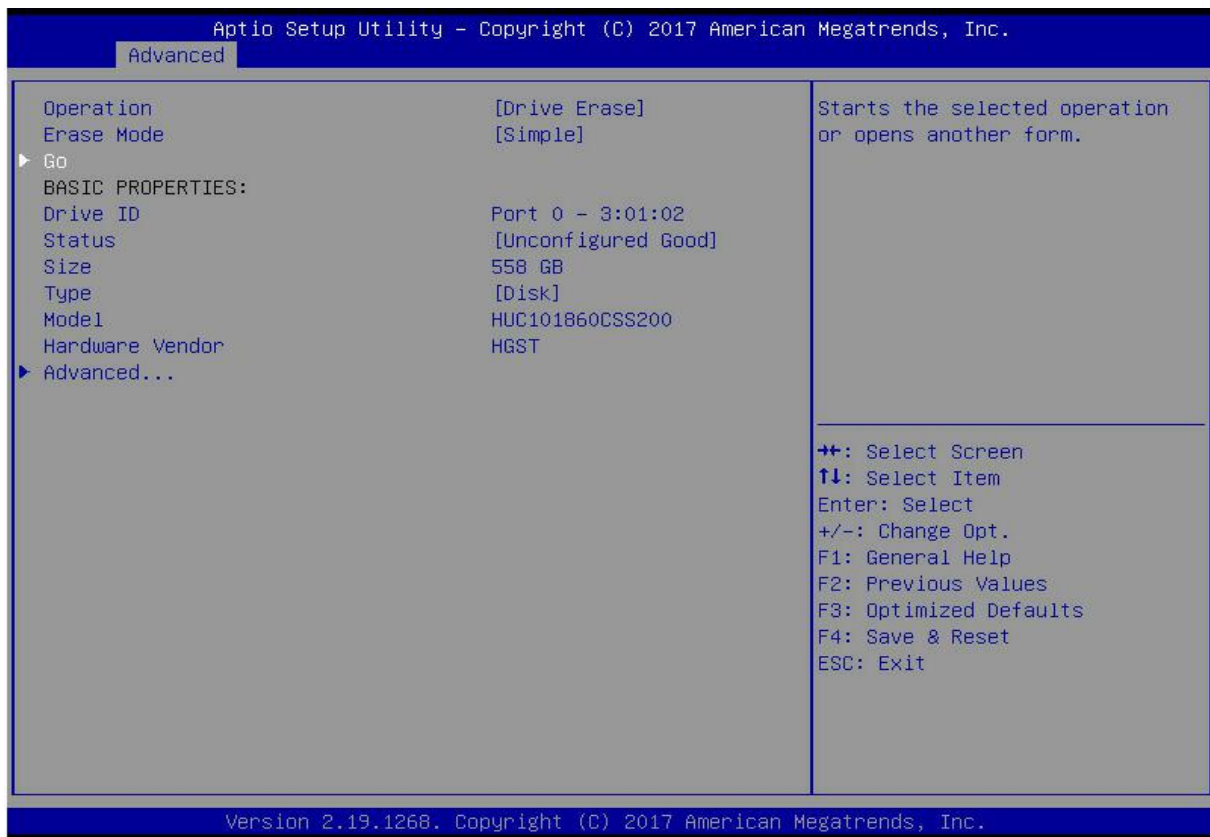

Figure 6- 81

Enter the interface shown in Figure 6-82, select Confirm to enable it, select Yes, and press Enter.

Figure 6-82 Confirm Erase

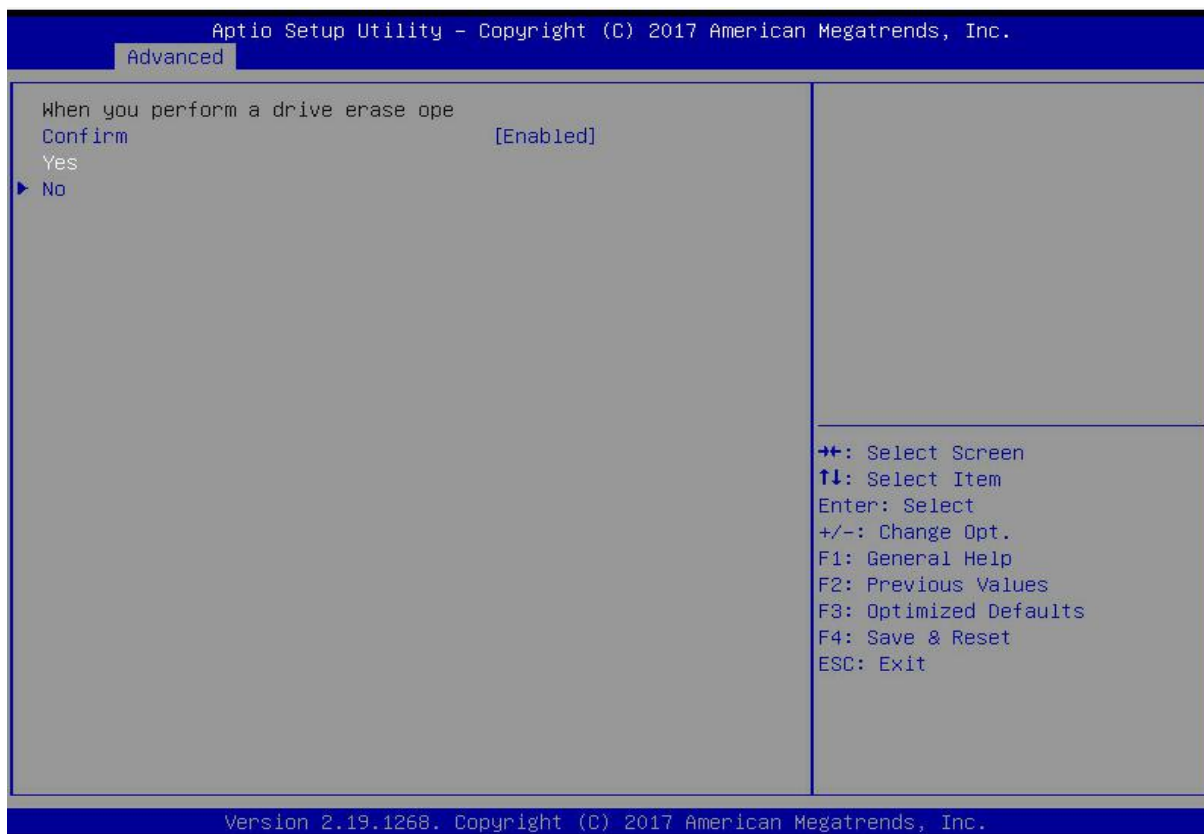

Figure 6- 82

Enter the interface shown in Figure 6-83 and complete the operation of erasing the physical disk data.
 Figure 6-83 Complete erasing physical disk data



Figure 6- 83

To avoid disk failure, do not perform other operations while erasing physical disk data.

As shown in Figure 6-84, select Virtual Drive Management on the RAID card configuration interface, and press Enter.

Figure 6-84 RAID card configuration interface

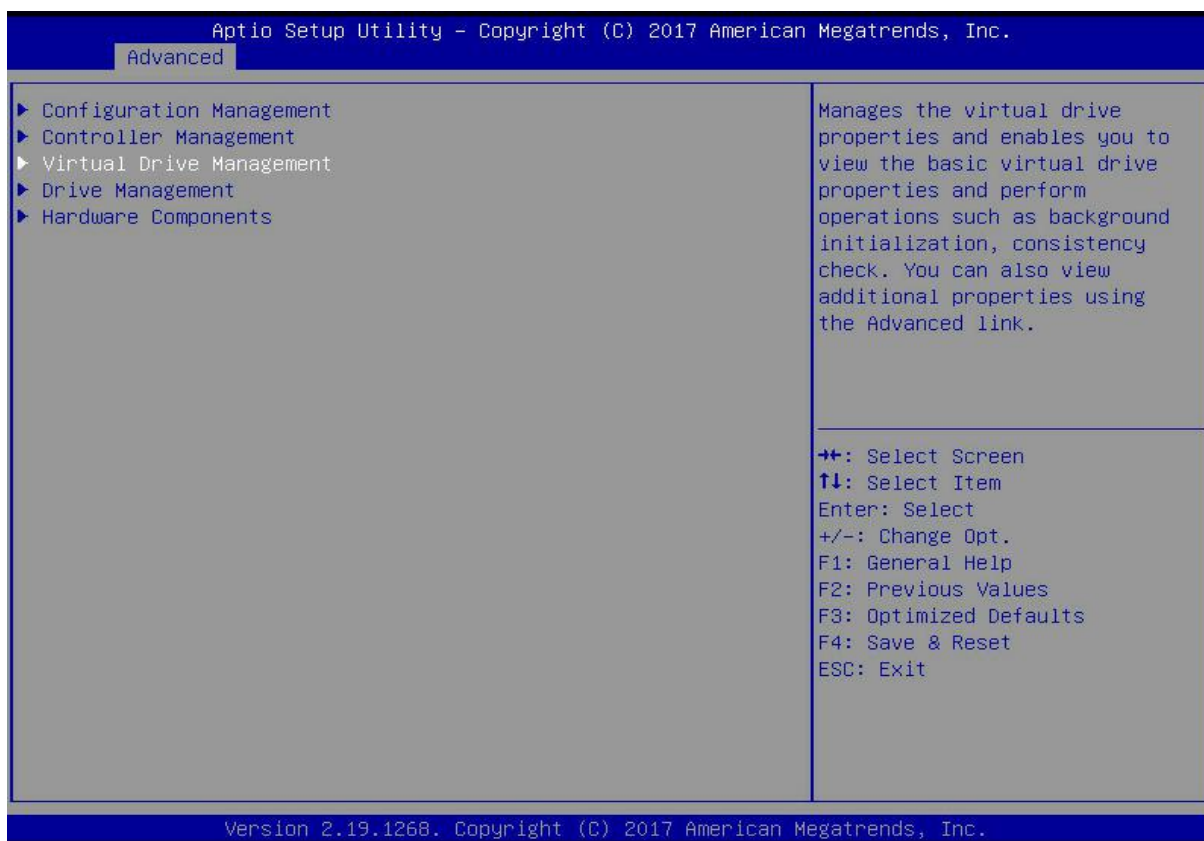

Figure 6-84

On the interface shown in Figure 6-85, select the logical disk whose data is to be erased, and press Enter.

Figure 6-85 Logical disk management interface

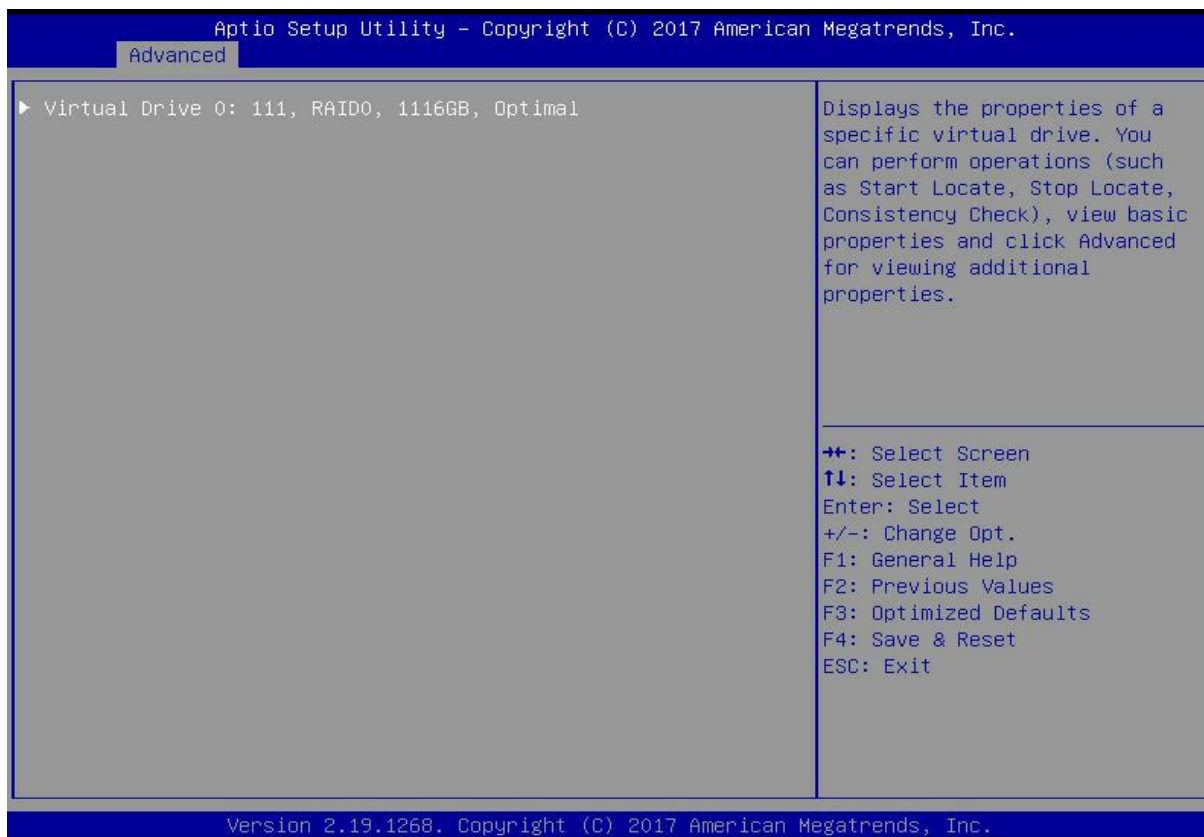

Figure 6- 85

Enter the interface shown in Figure 6-86, select Operation, and press Enter. In the displayed dialog box, select Virtual Drive Erase and press Enter.

Figure 6-86 Operation interface

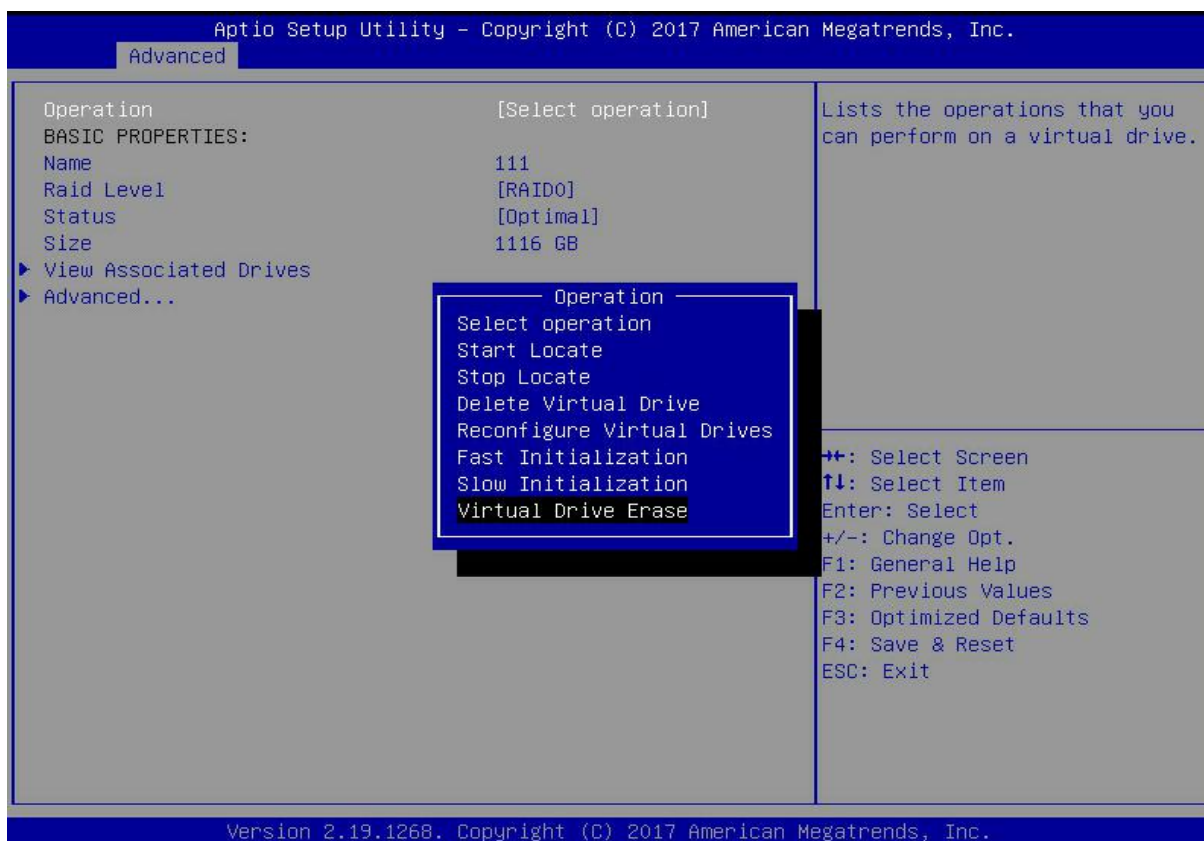

Figure 6-86

Enter the interface shown in Figure 6-87, press Enter, and then select the erase mode in the pop-up dialog box (the default mode is recommended: Simple).

Figure 6-87 Erase Mode interface

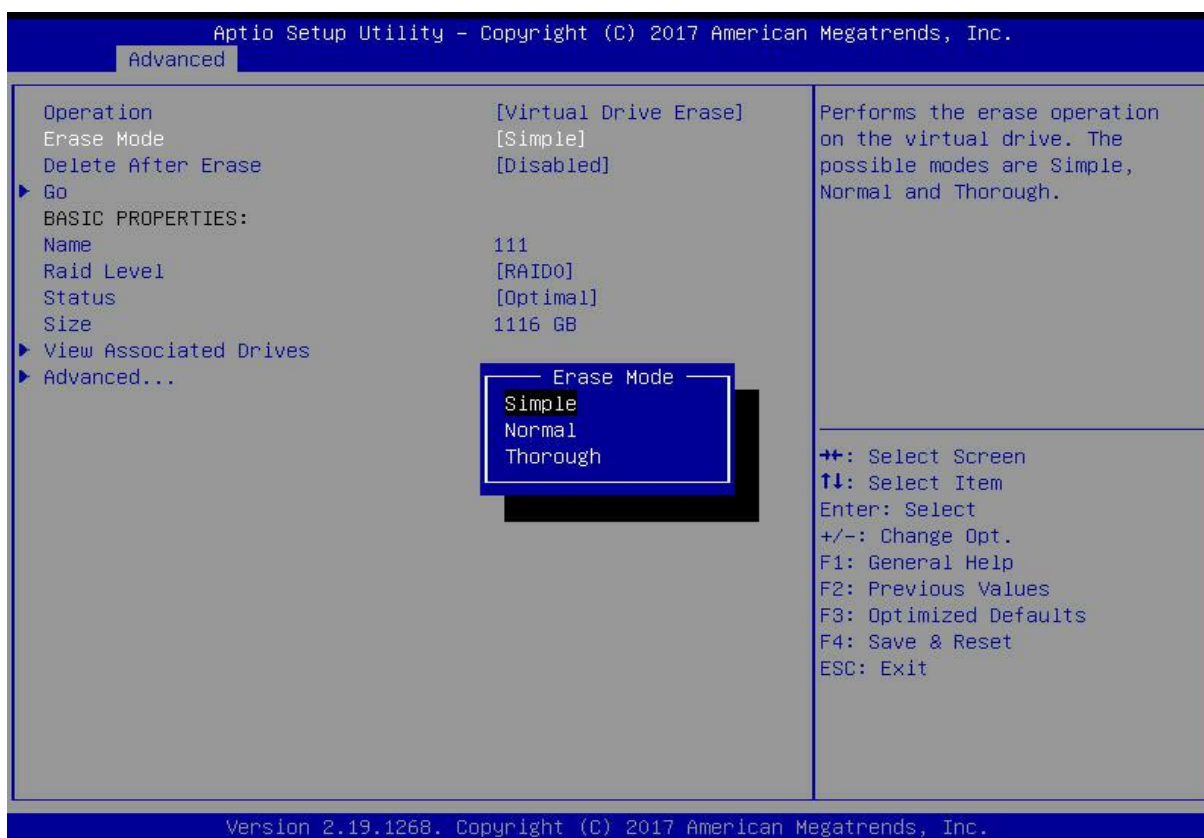

Figure 6- 87

Enter the interface shown in Figure 6-88, select Go, and press Enter.

Figure 6-88 Select Go



Figure 6- 88

Enter the interface shown in Figure 6-89, select Confirm to enable it, select Yes, and press Enter.

Figure 6-89 Confirm Erase

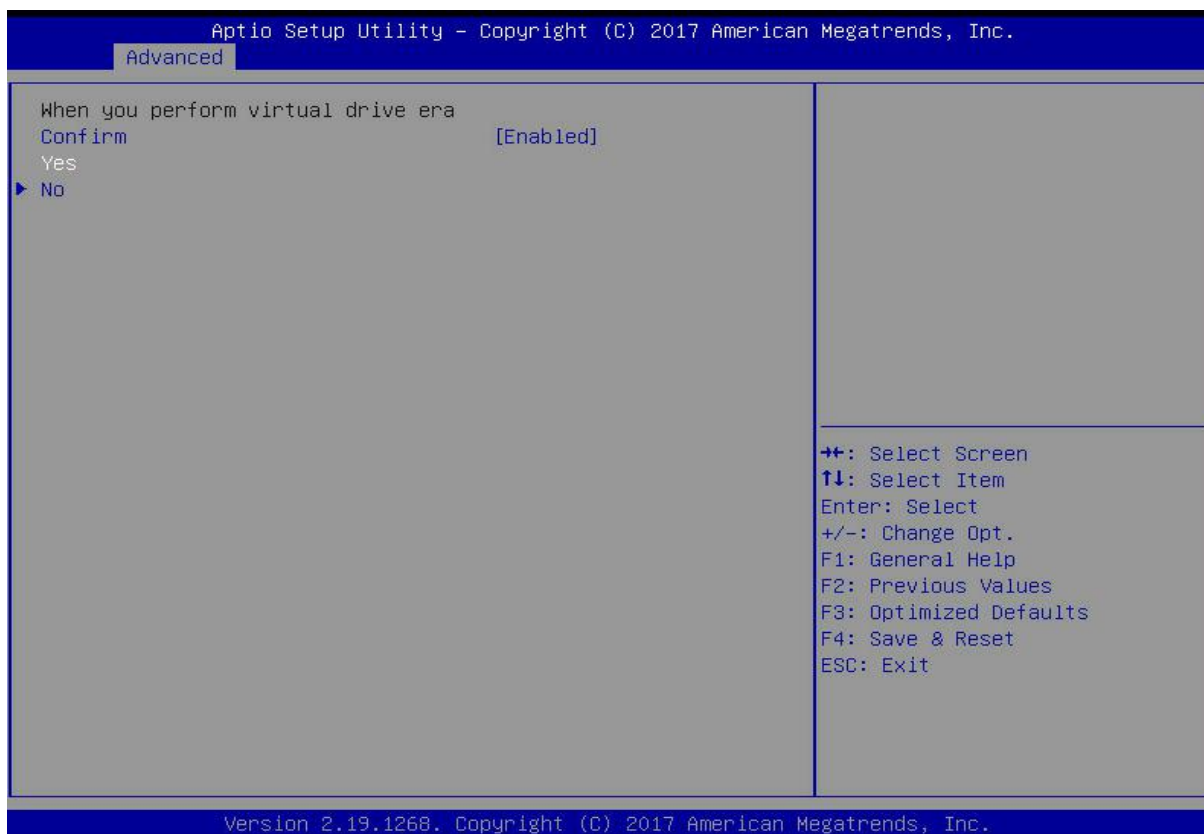

Figure 6- 89

Enter the interface shown in Figure 6-90 and complete the operation of erasing the logical disk data.
Figure 6-90 Completion of erasing logical disk data

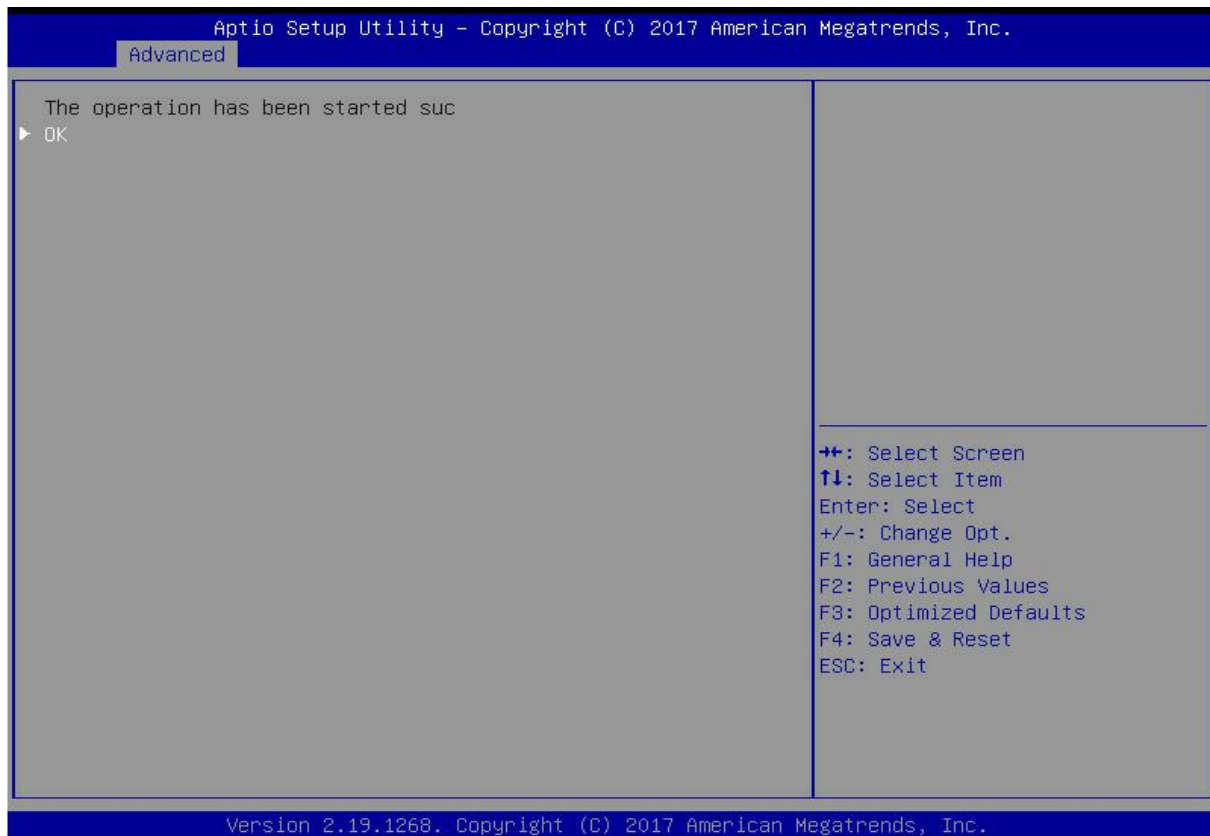

Figure 6- 90

Migrating RAID levels:

This function is used to modify the RAID level to meet the configuration requirements without affecting the current data integrity.

As shown in Figure 6-91, select Virtual Drive Management on the RAID card configuration interface, and press Enter.

Figure 6-91 RAID card configuration interface

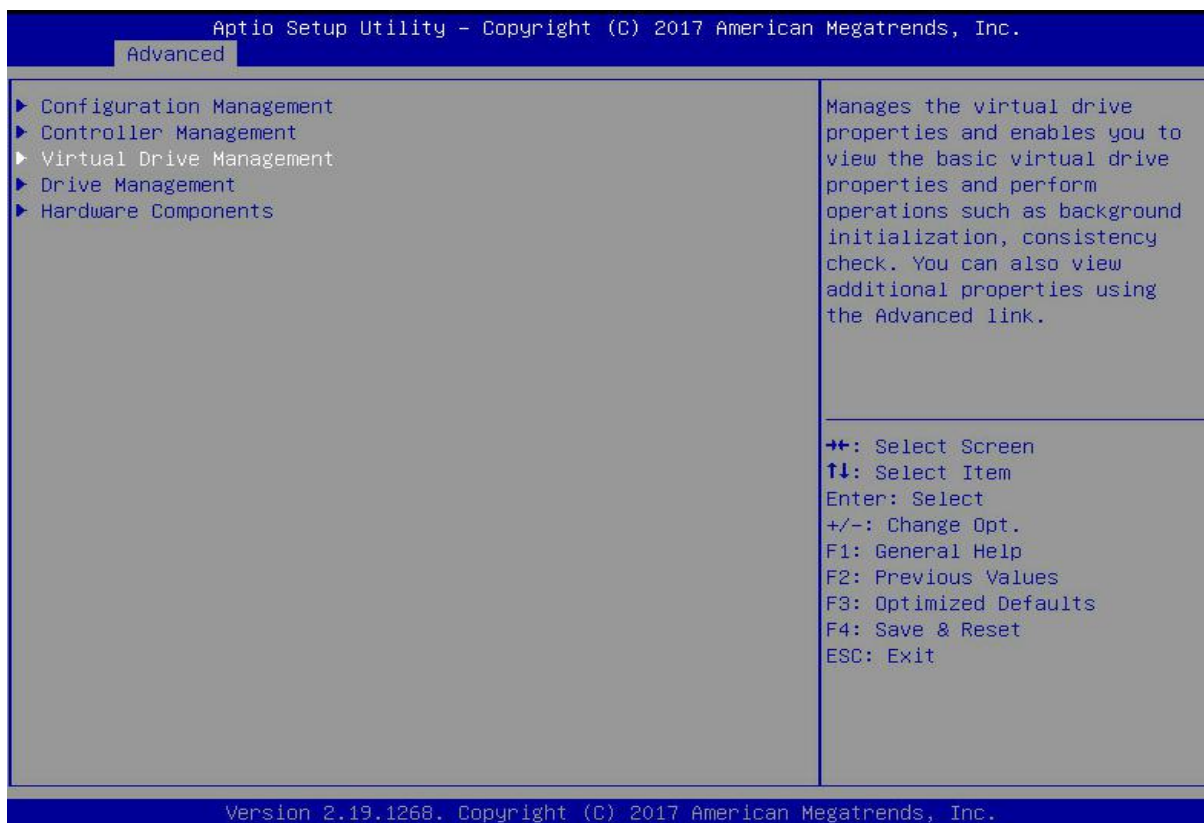

Figure 6- 91

The interface shown in Figure 6-92 is displayed, select the logical disk to be rebuilt, and press Enter.
 Figure 6-92 Virtual Drive Management management interface

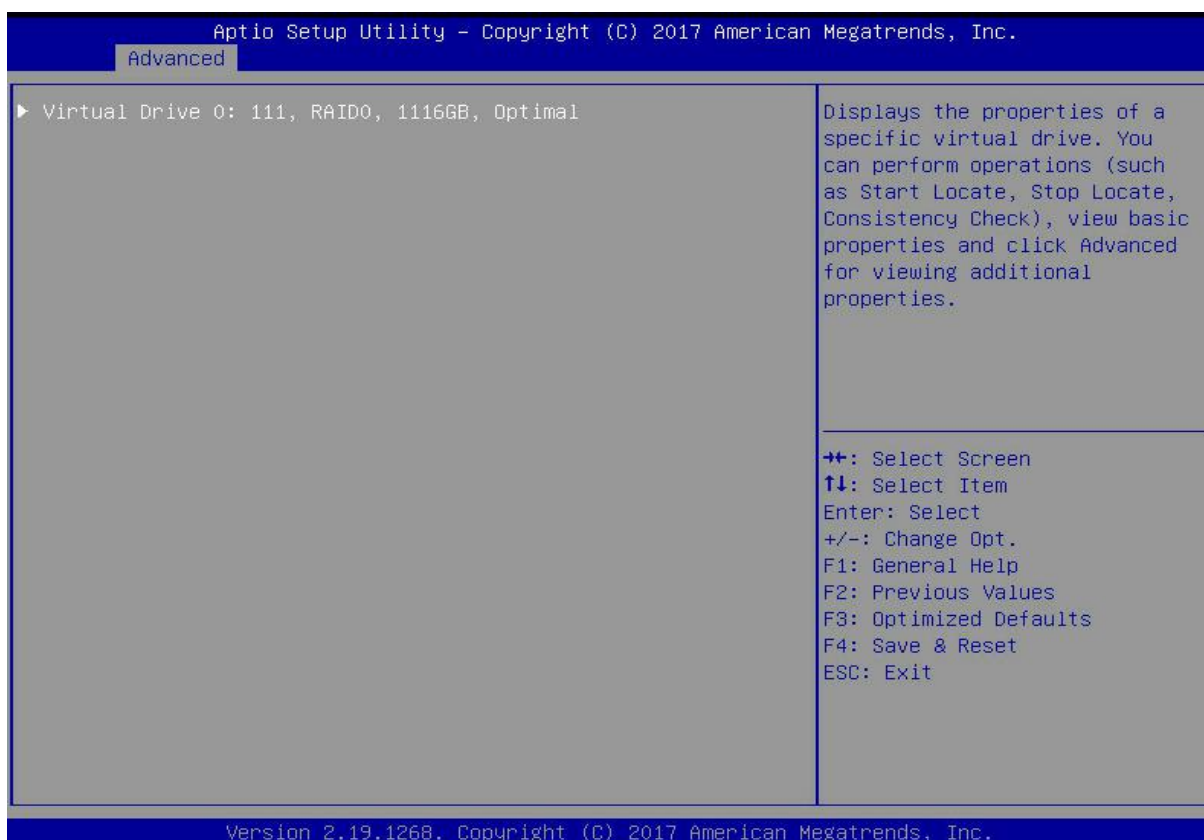

Figure 6- 92

Enter the interface shown in Figure 6-93, select Operation, and press Enter. In the displayed dialog box, select Reconfigure Virtual Drive, and press Enter.
 Figure 6-93 Operation interface

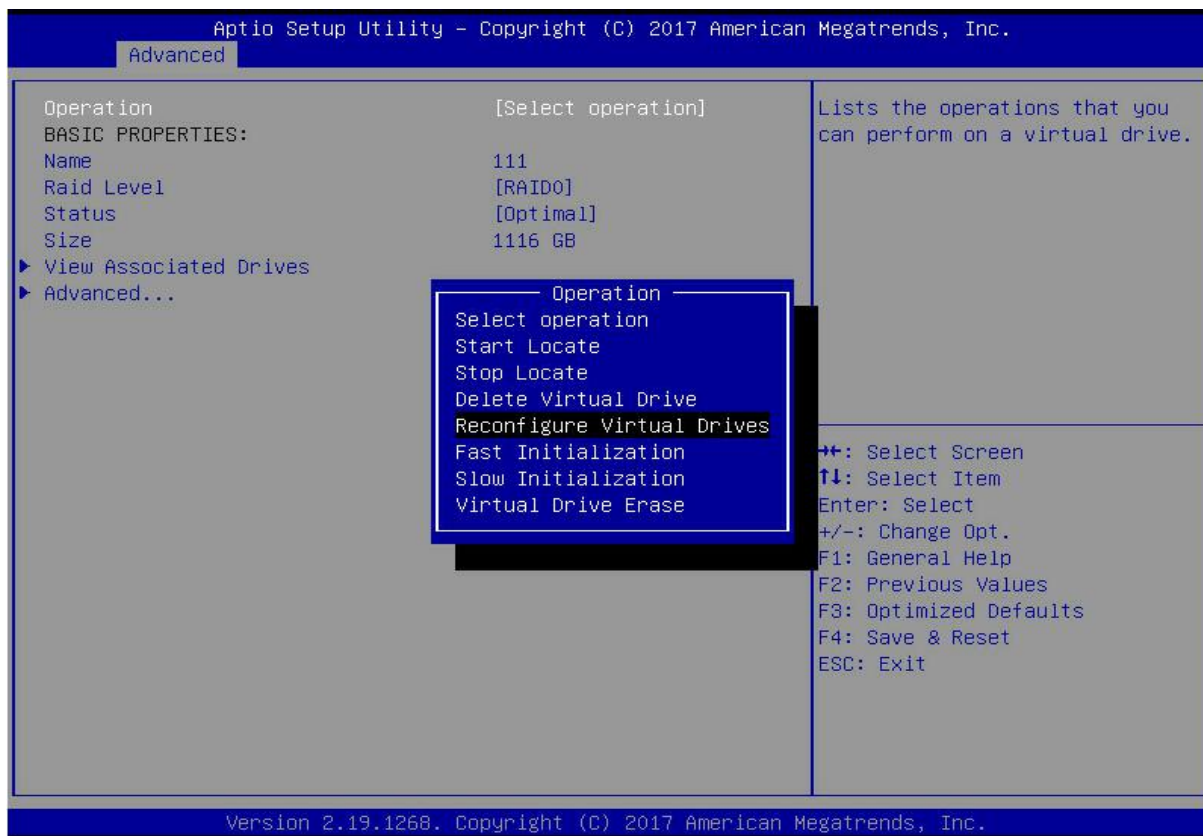

Figure 6- 93

Enter the interface shown in Figure 6-94, select Go, and press Enter.

Figure 6-94 Select Go

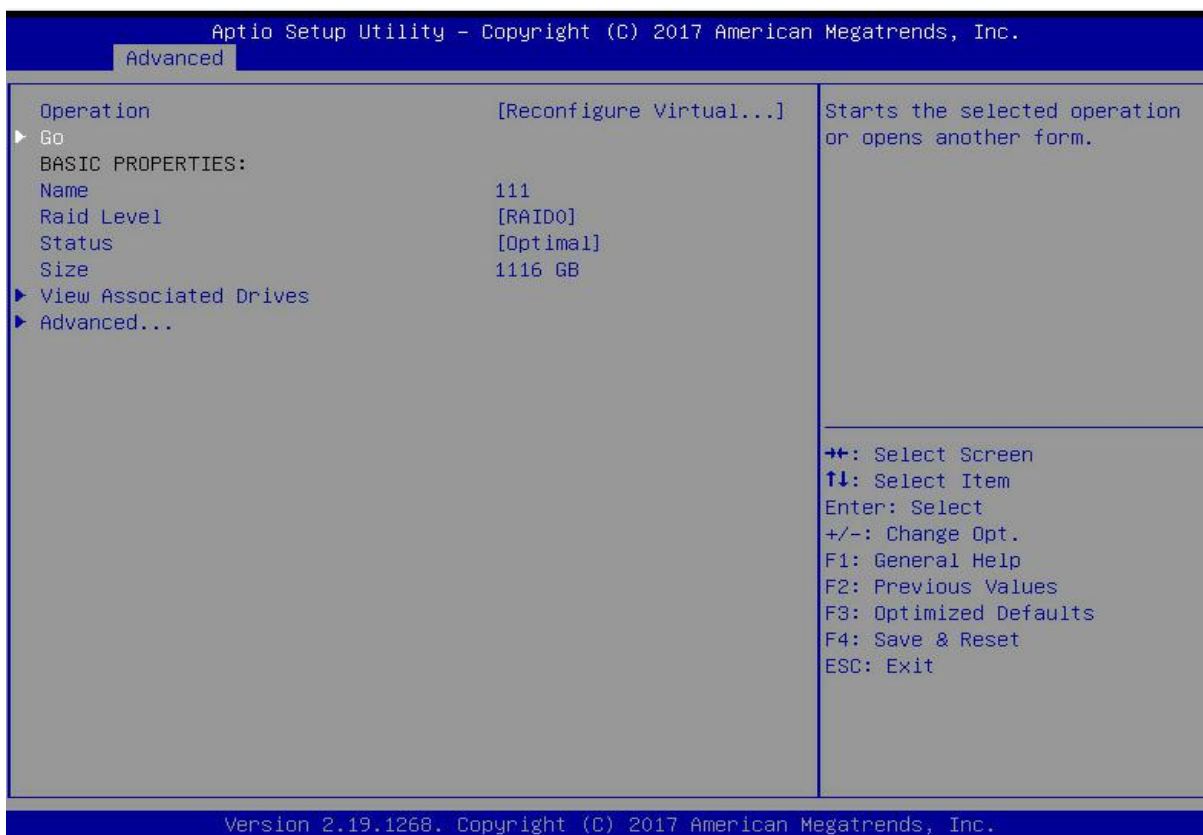

Figure 6- 94

On the interface shown in Figure 6-95, set the RAID level, select Add Drives, and press Enter.

Figure 6-95 Advanced interface

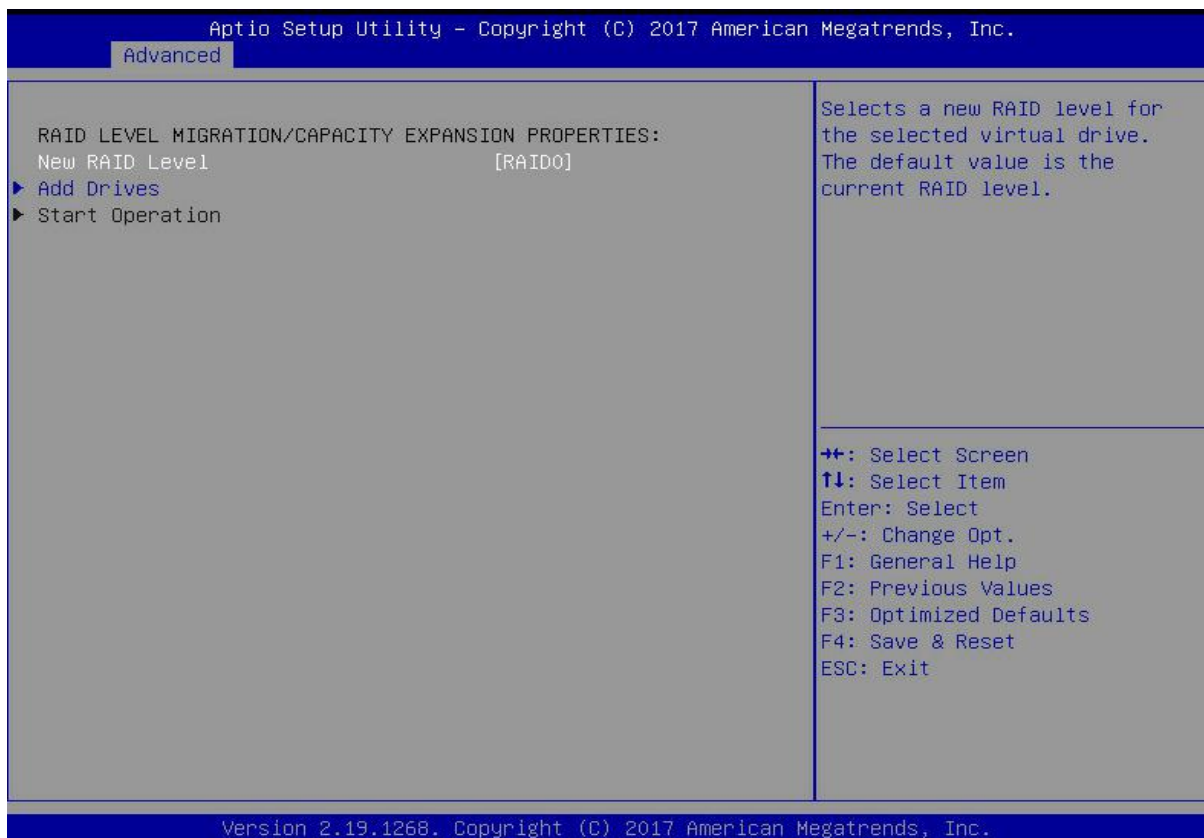

Figure 6- 95

On the interface shown in Figure 6-96, select the disk to be added, make it Enabled, select Apply Changes, and press Enter.

Figure 6-96 Add Drives interface

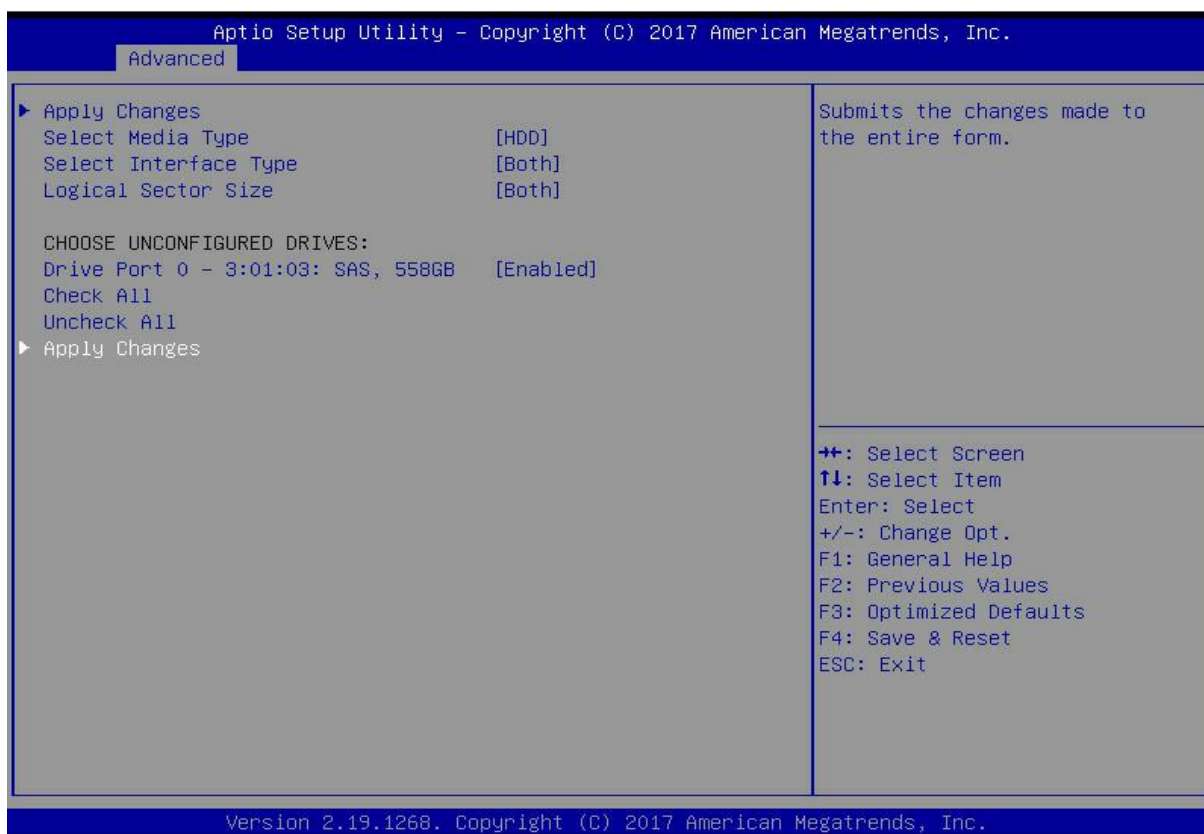

Figure 6- 96

Enter the interface shown in Figure 6-97, select Confirm to enable it, select Yes, and press Enter.

Figure 6-97 Confirm migration

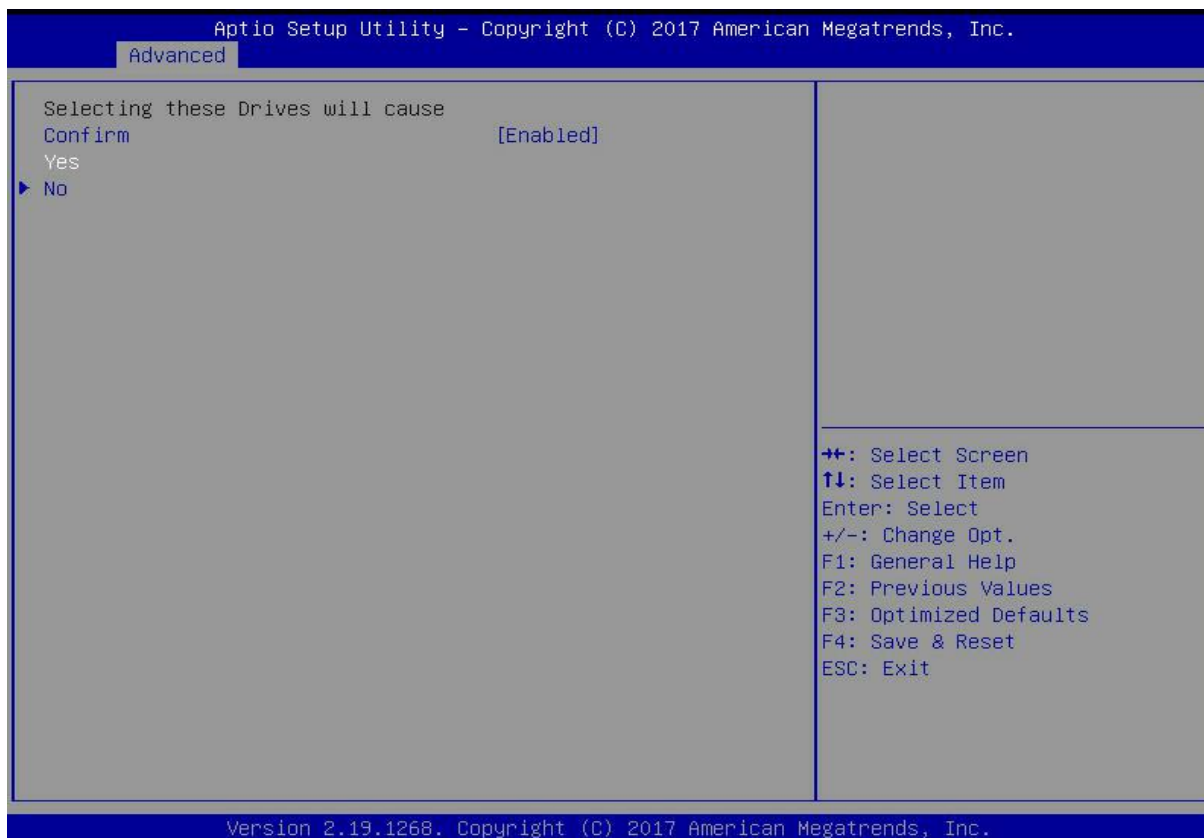

Figure 6- 97

On the interface shown in Figure 6-98, select Start Operation, and press Enter.

Figure 6-98 Start Operation interface

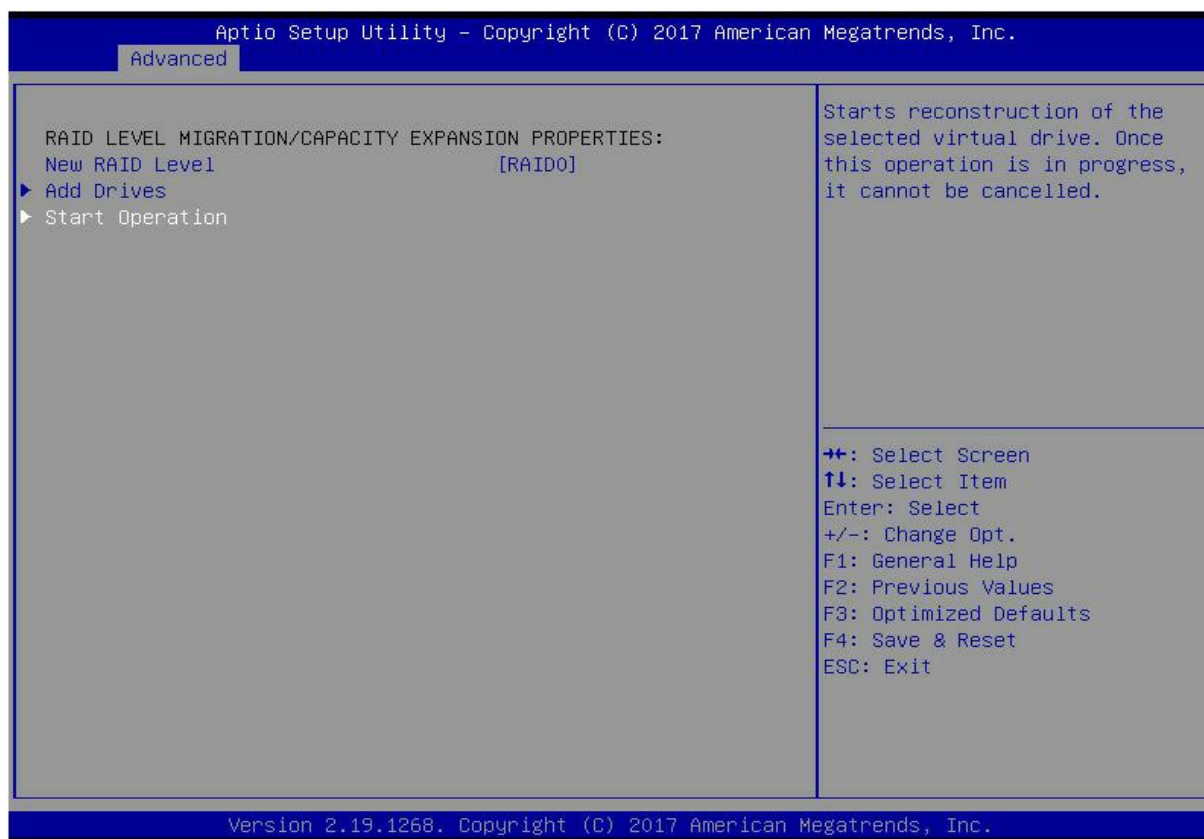

Figure 6- 98

Enter the interface shown in Figure 6-99, select OK, and press Enter.

Figure 6-99 Select OK



Figure 6- 99

On the interface shown in Figure 6-100, you can view the current migration progress.

Figure 6-100 RAID information interface

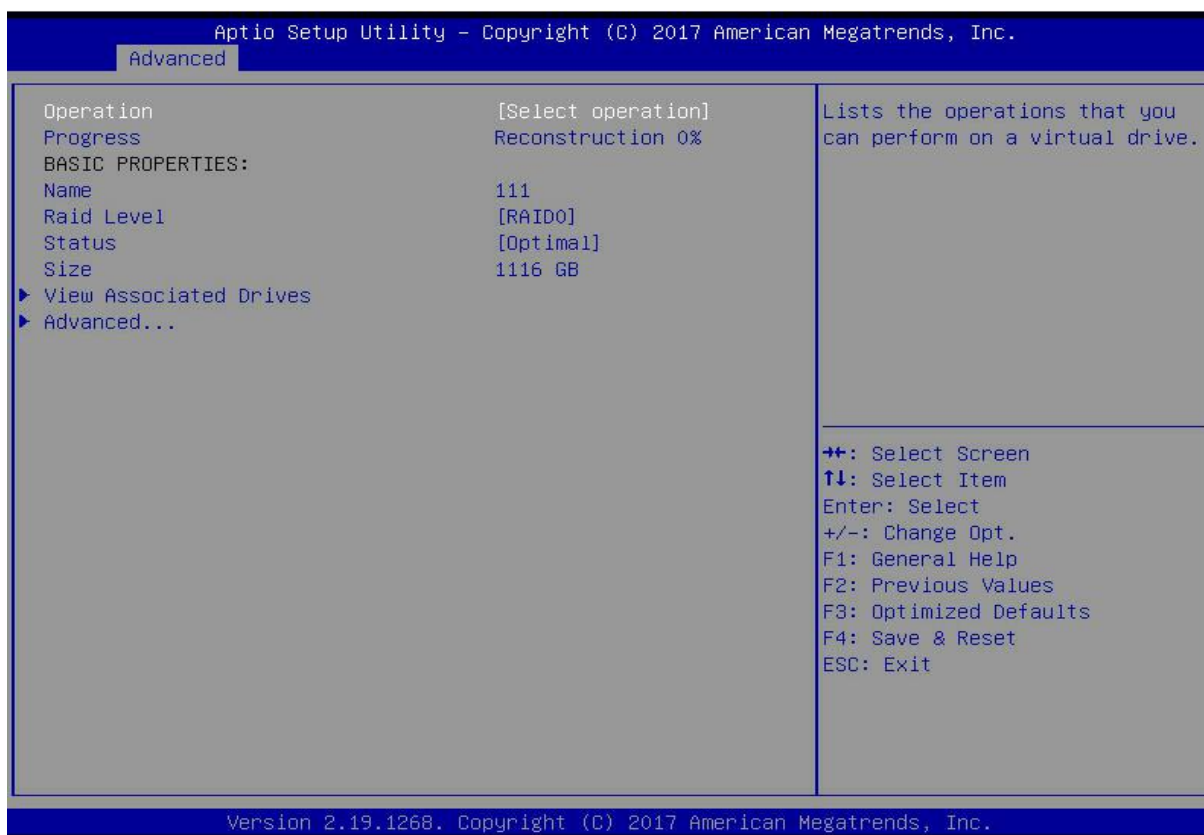

Figure 6- 100

Clear disk RAID information:

This function is used to clear the residual RAID information in the disk, so that the disk can be reused for RAID configuration. This function is often used for disks whose mode is Unconfigured Bad.

Switch the disk mode Unconfigured Bad to Unconfigured Good.

As shown in Figure 6-101, select Configuration Management on the RAID card configuration interface, and press Enter.

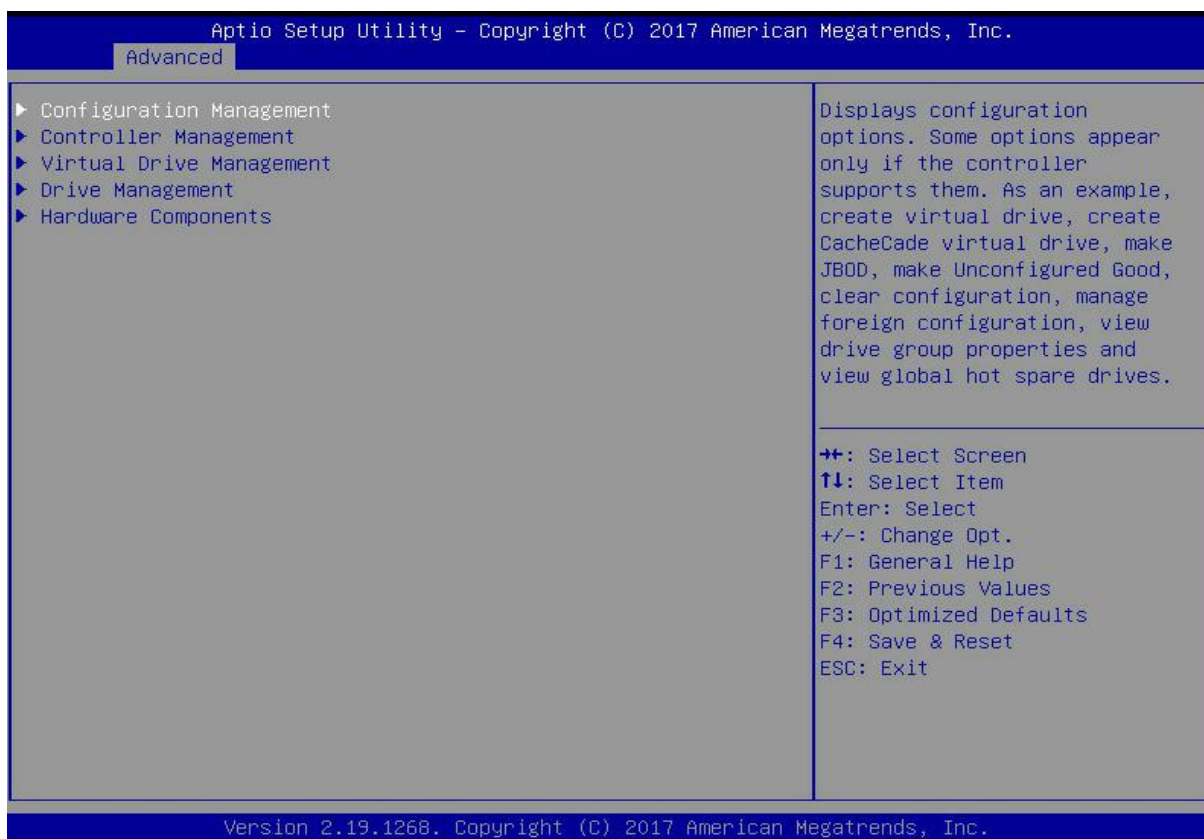

Figure 6- 101

On the interface shown in Figure 6-102, select Manage Foreign Configuration, and press Enter.

Figure 6-102 Select Manage Foreign Configuration

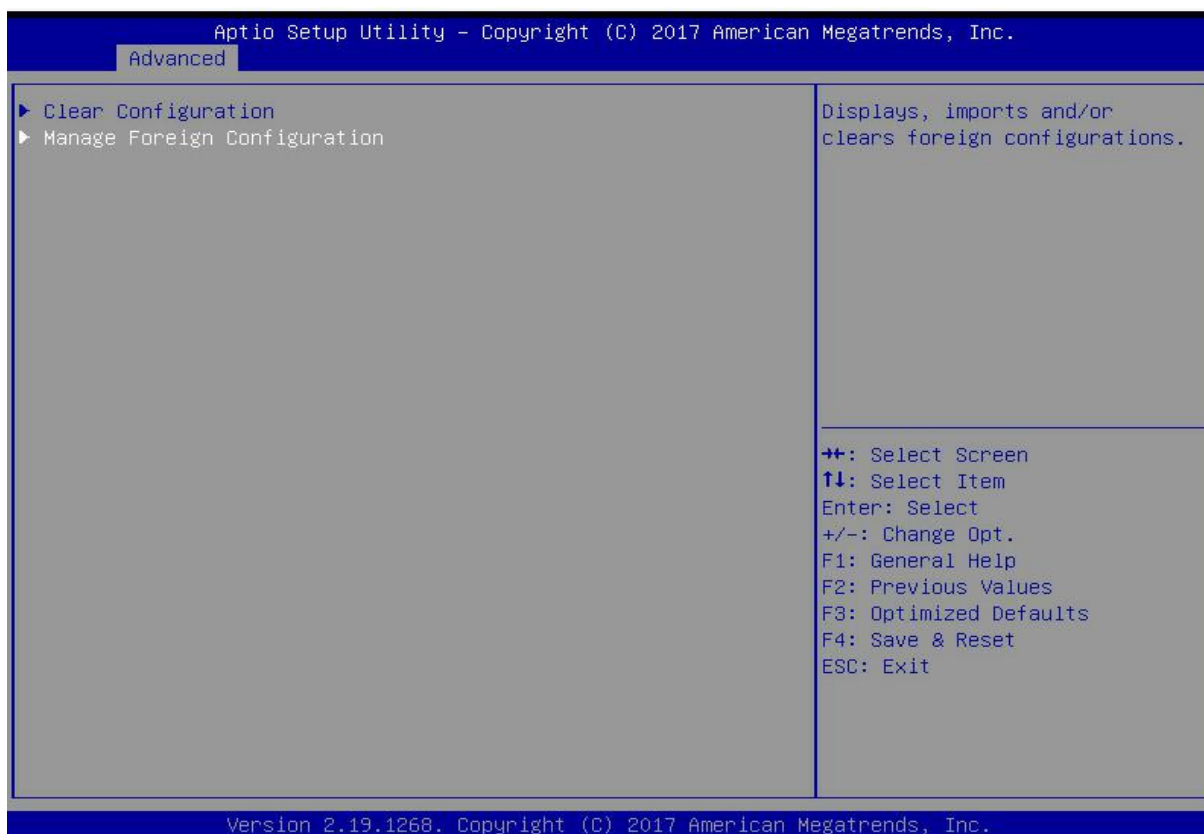

Figure 6- 102

Enter the interface shown in Figure 6-103, select Clear Foreign Configuration, and press Enter.

Figure 6-103 Select Clear Foreign Configuration

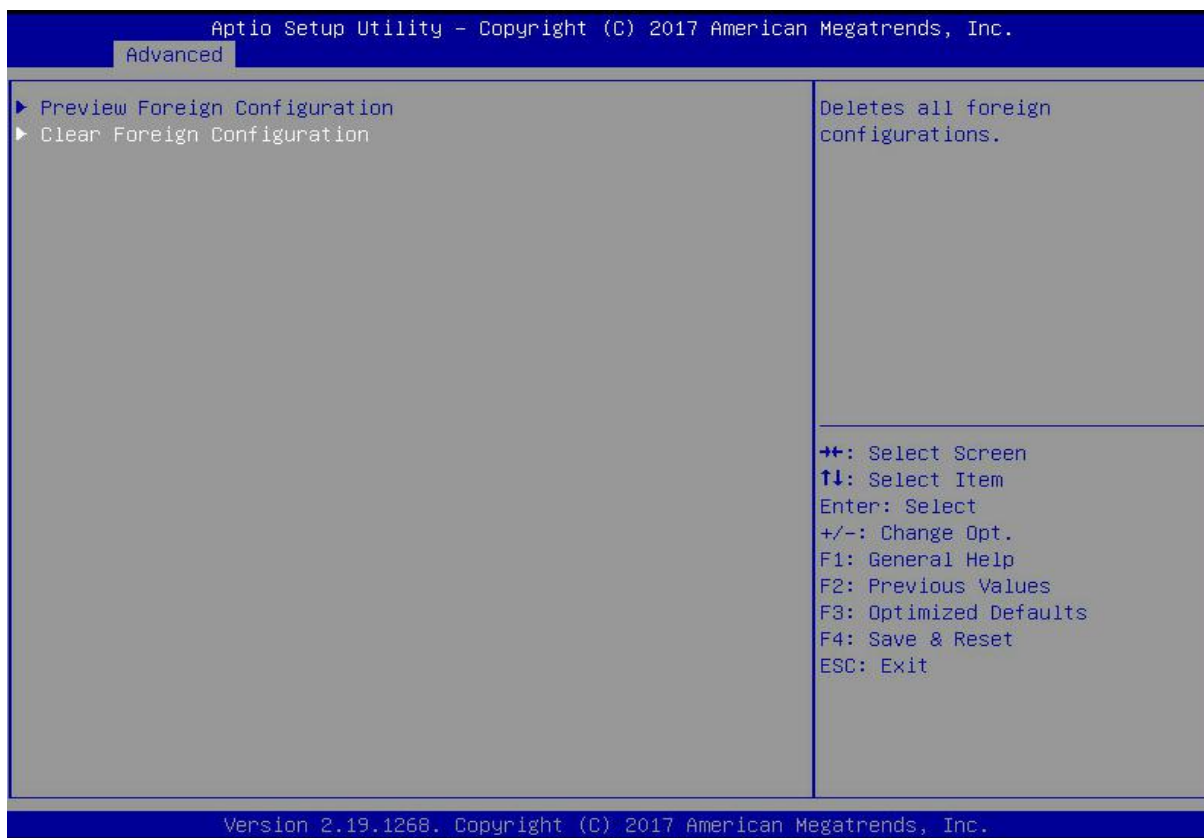

Figure 6- 103

Enter the interface shown in Figure 6-104, select Confirm to enable it, select Yes, and press Enter.

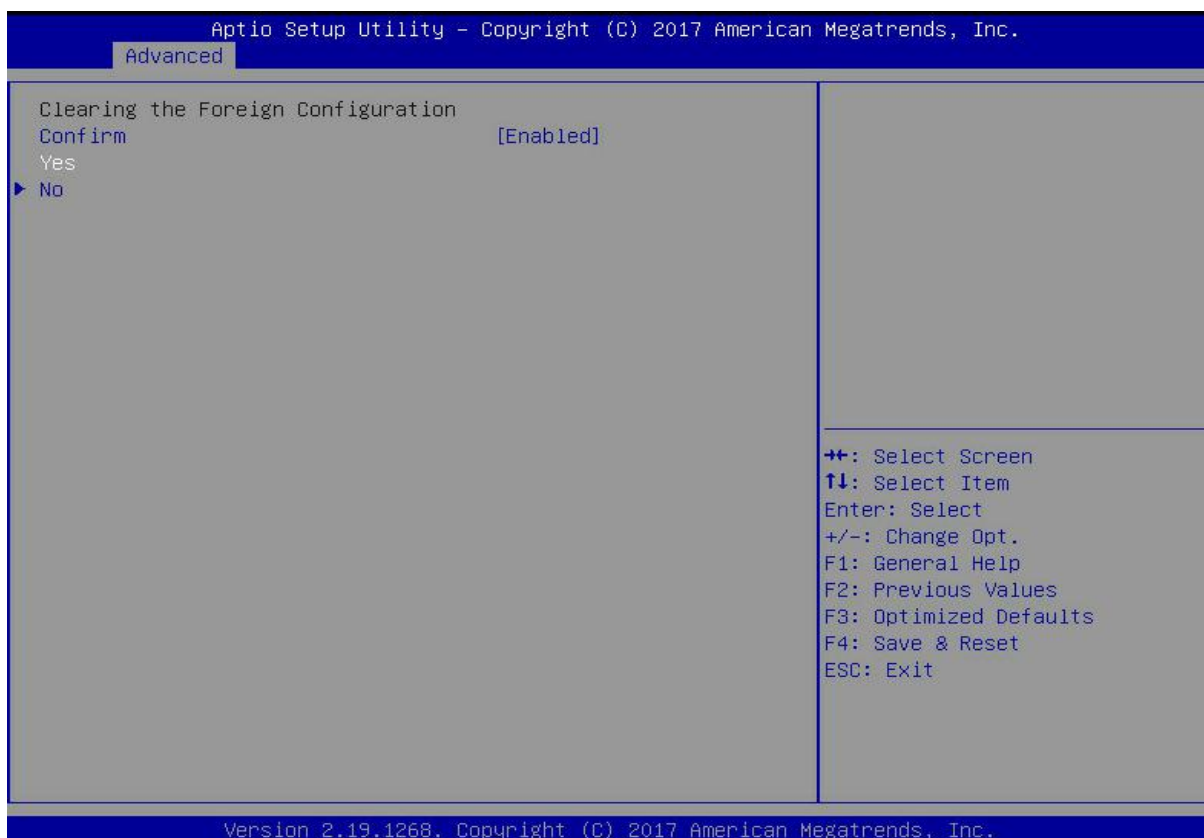

Figure 6- 104

Enter the interface shown in Figure 6-105 and complete the operation of clearing disk RAID information.

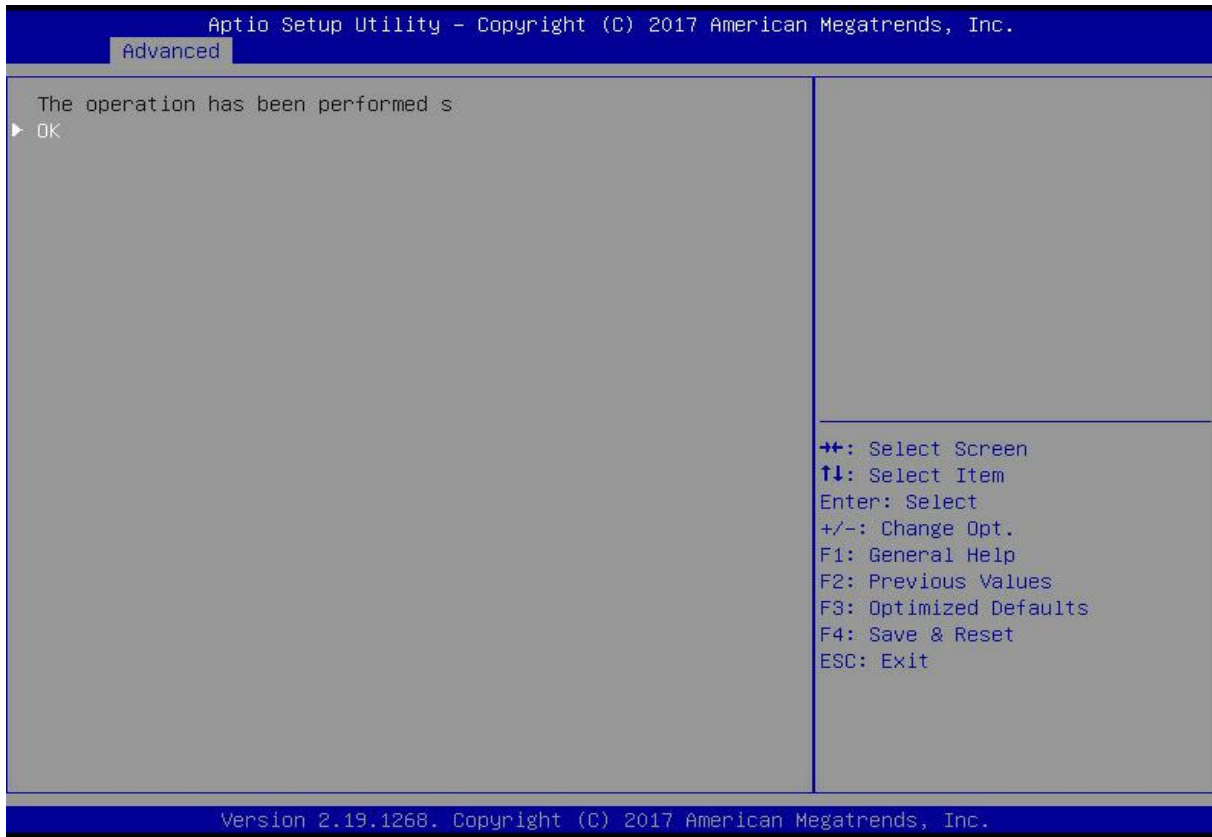

Figure 6- 105

6.2.2 Configuring RAID in Legacy Boot Mode

Enter the RAID card configuration interface

During the BIOS startup, when the interface shown in Figure 6-105 is displayed, press Ctrl+R.

Figure 6-106 Press Ctrl+R according to the prompt during BIOS startup

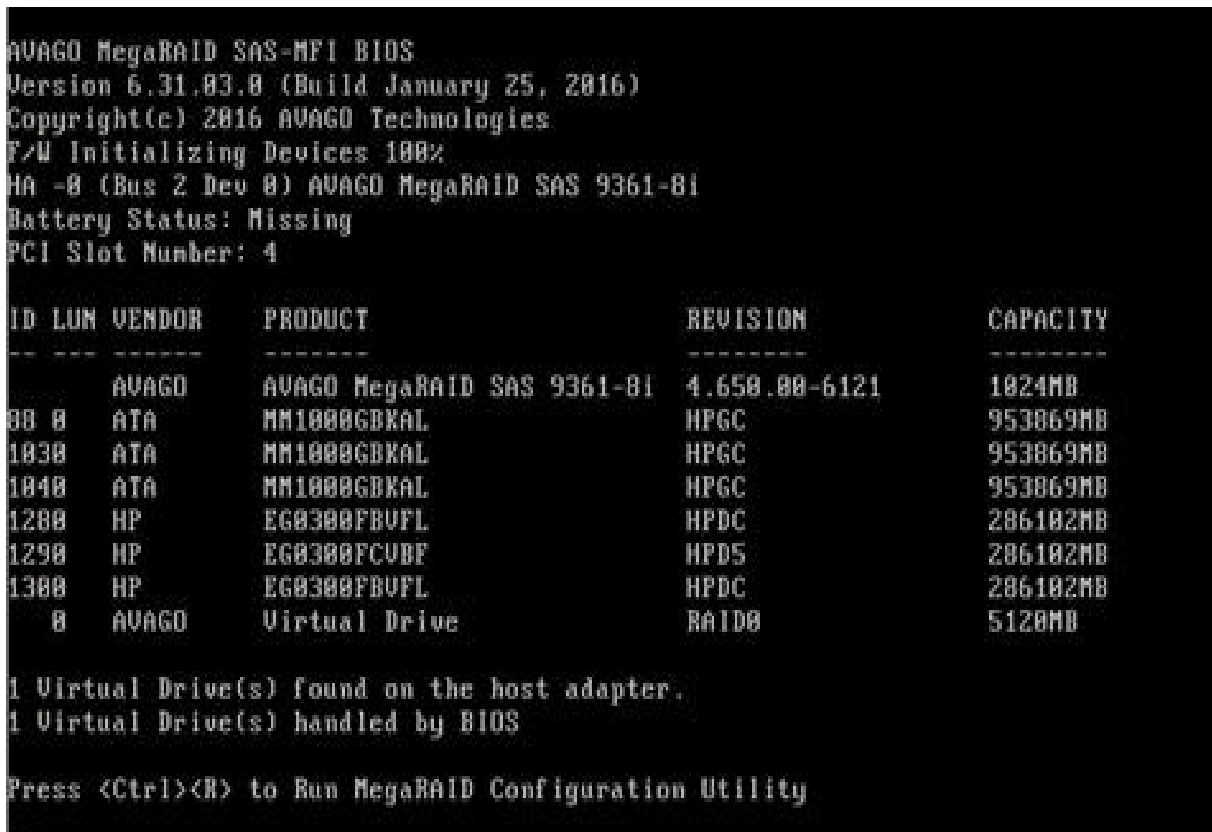

Figure 6- 106

Enter the interface shown in Figure 6-107. Please refer to the key operation tips at the lower border of the interface to navigate the interface and modify settings.

Figure 6-107 LSI RAID management interface

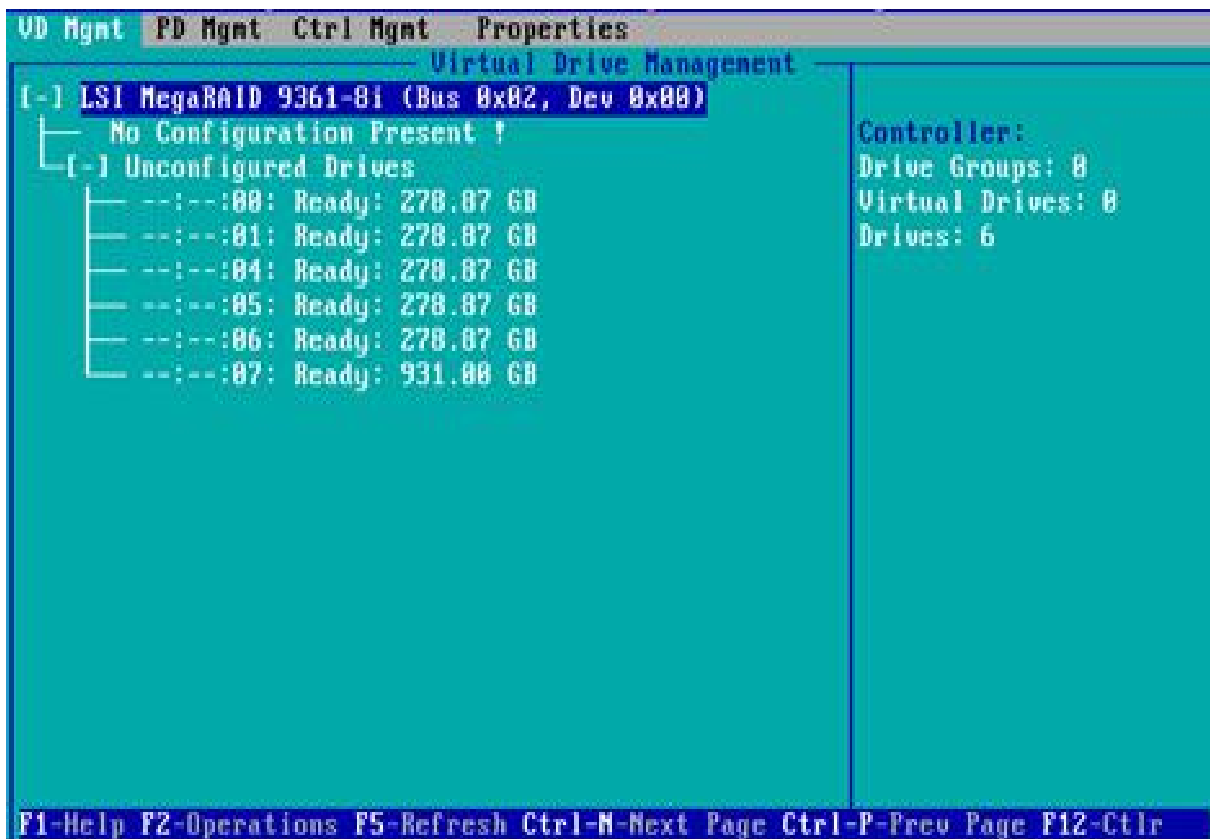

Figure 6- 107

Common tasks

Configure RAID:

As shown in Figure 6-108, press F2 on the VD Mgmt interface and select Create Virtual Drive.

Figure 6-108 Select Create Virtual Drive

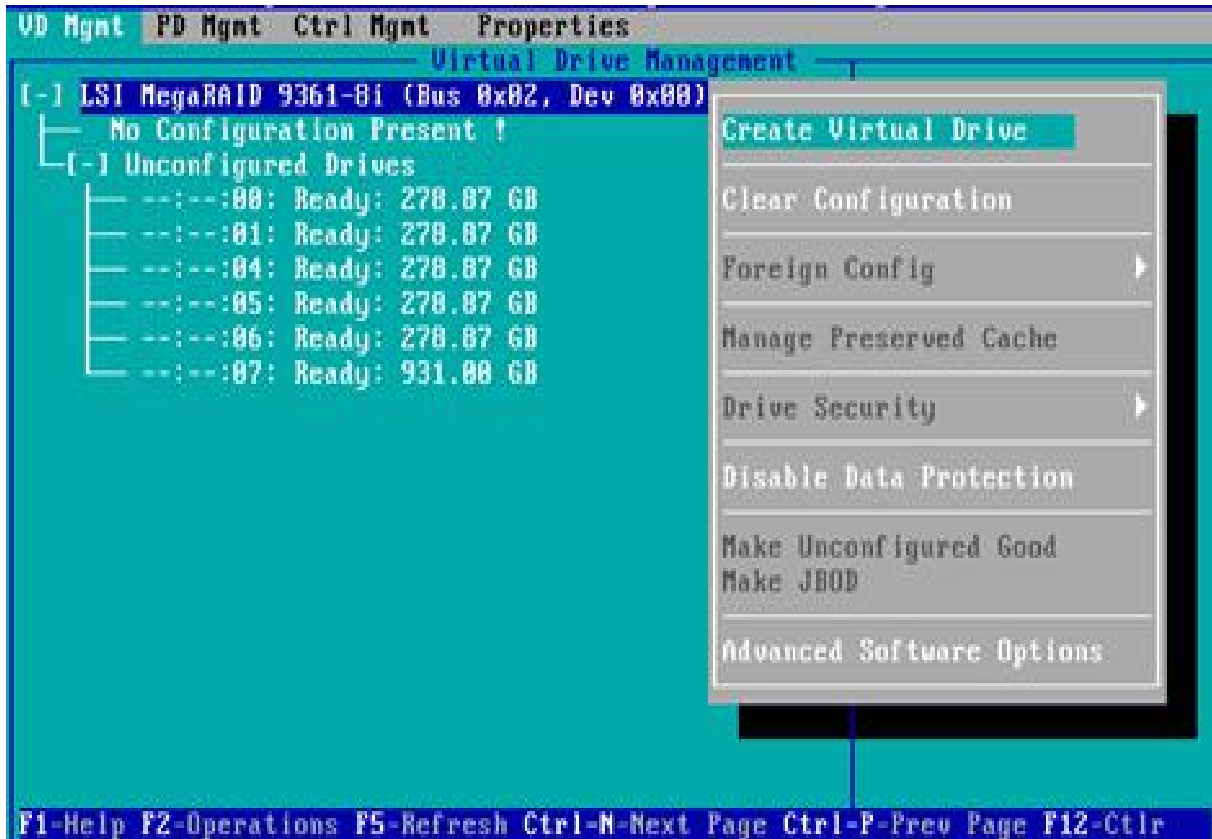

Figure 6- 108

Enter the interface shown in Figure 6-109, set the RAID level, and press Enter.

Figure 6-109 Setting the RAID level

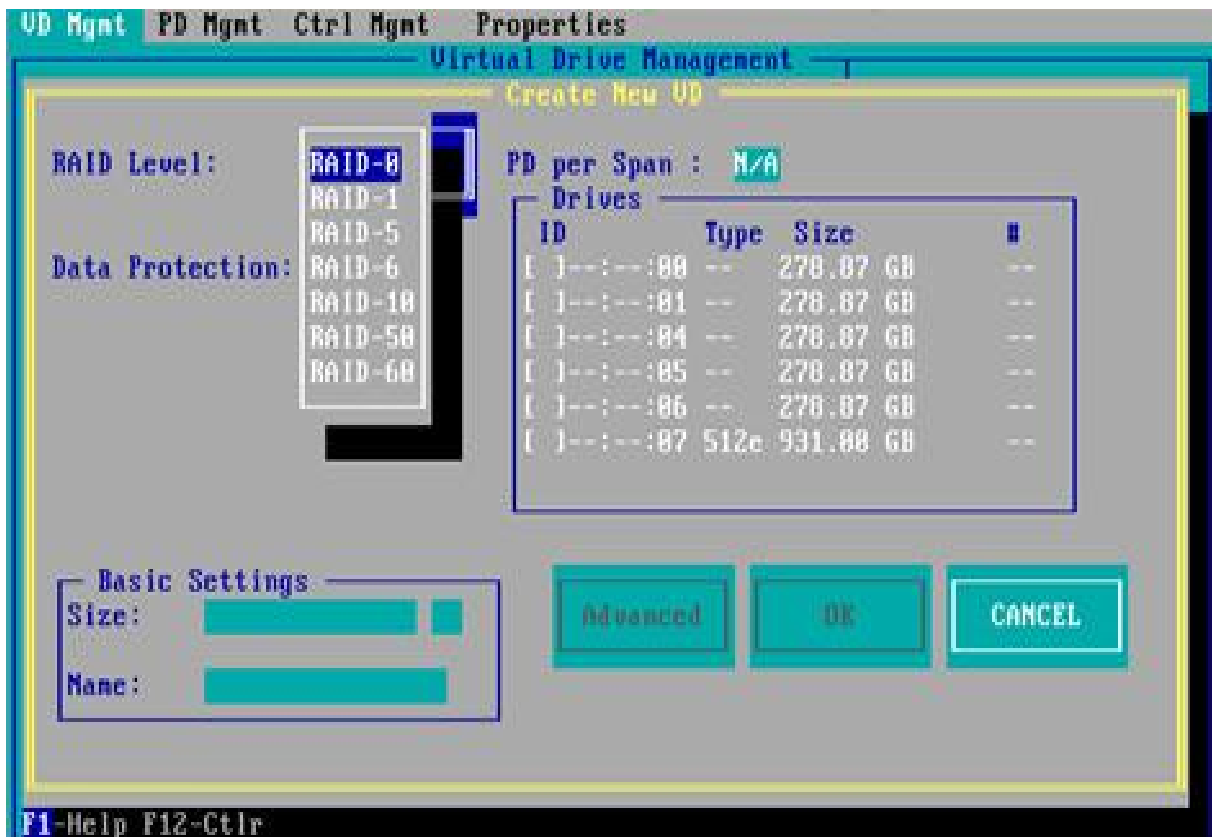

Figure 6- 109

The interface shown in Figure 6-110 is displayed, select the disk for configuring RAID, and press Enter.

Figure 6-110 Select disk

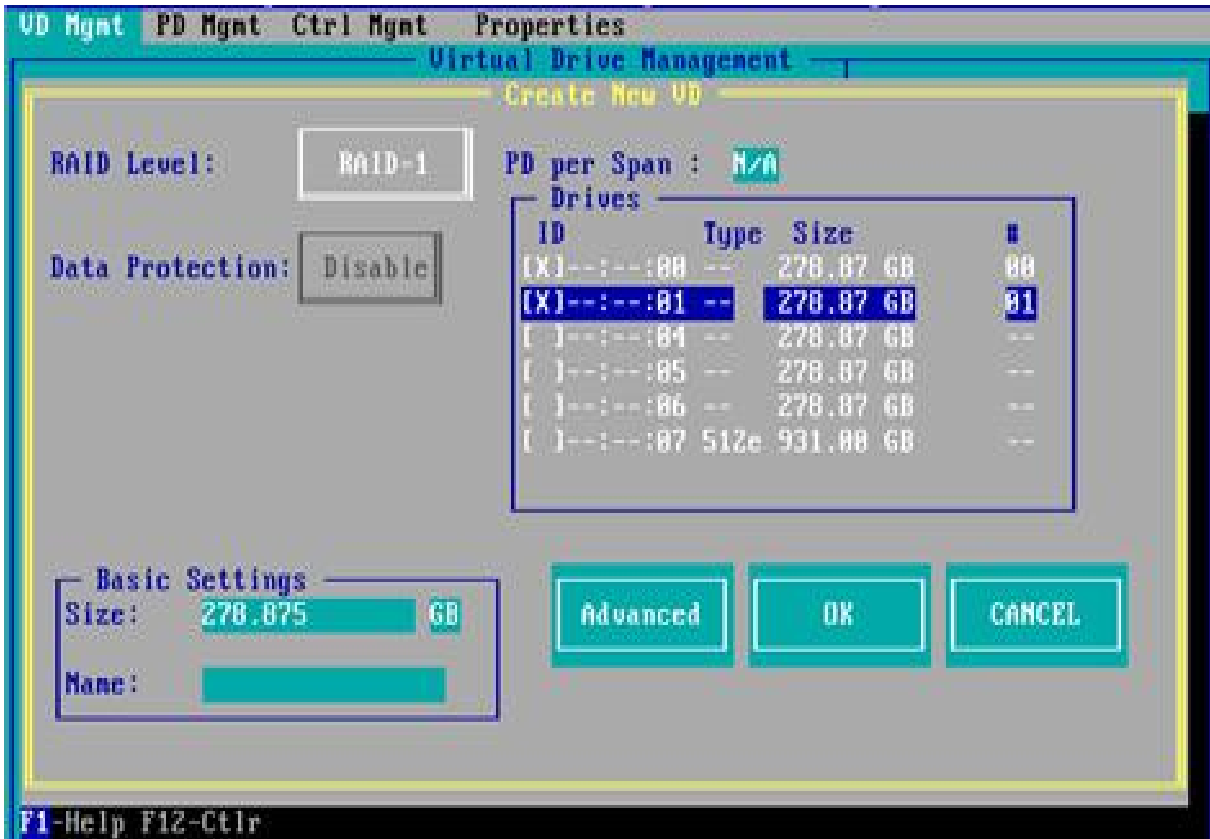

Figure 6- 110

Enter the interface shown in Figure 6-111, set the Size and Name accordingly, select Advanced, and press Enter.

Figure 6-111 Setting the RAID name and capacity



Figure 6- 111

Enter the interface shown in Figure 6-112, set relevant parameters, select OK, and press Enter.

Figure 6-112 Setting advanced parameters



Figure 6- 112

Enter the interface shown in Figure 6-113, select OK, and press Enter to complete the RAID configuration operation.

Figure 6-113 Confirm creation

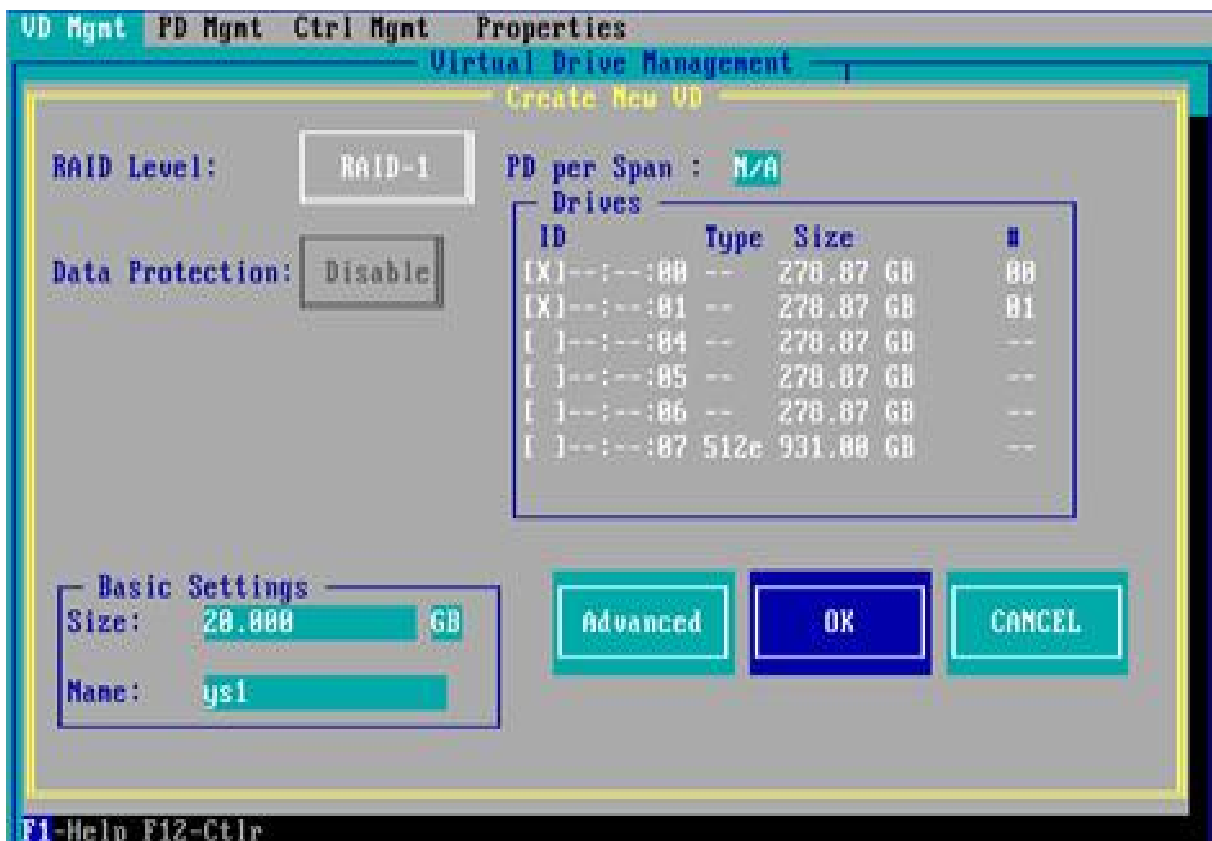

Figure 6- 113

Select the RAID to be viewed and press Enter to view the detailed information of the RAID (including the RAID name, level, and disk information), as shown in Figure 6-114.

Figure 6-114 Viewing RAID information

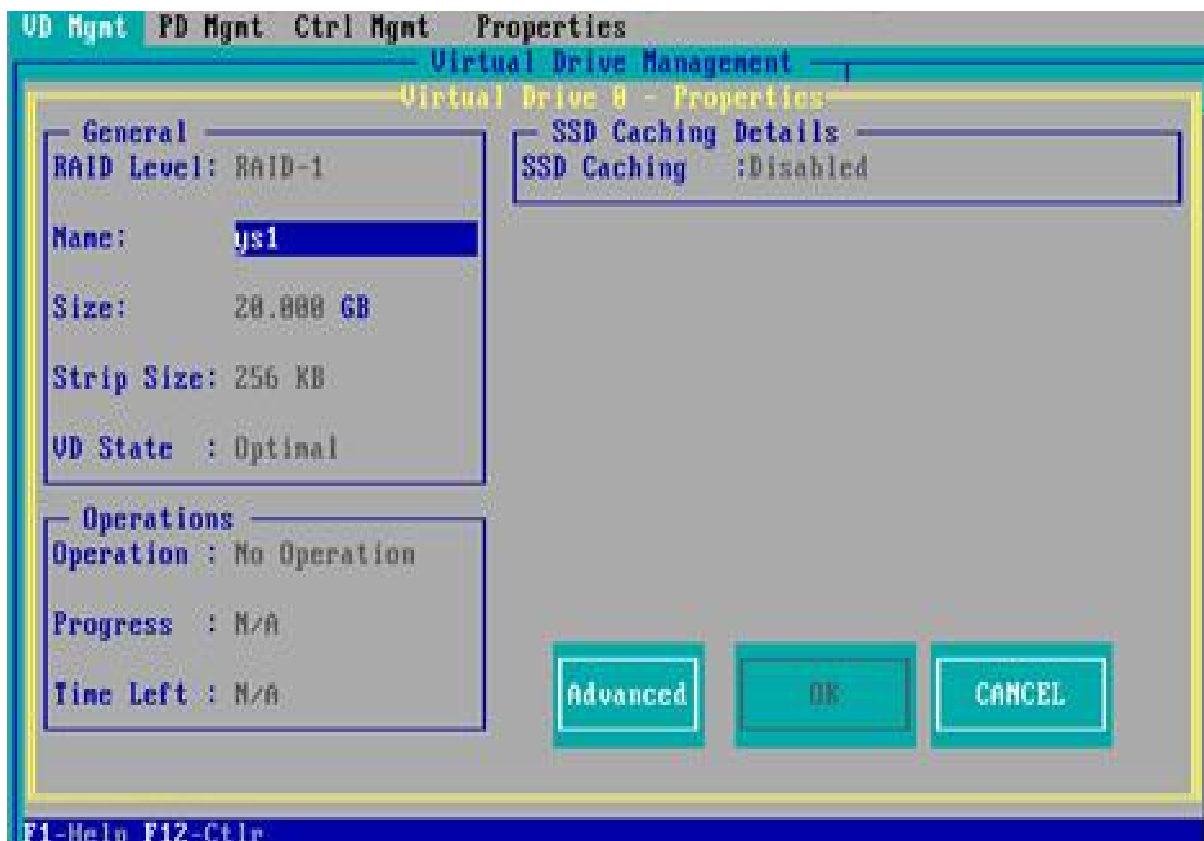

Figure 6- 114

To configure a hot spare disk:

After configuring RAID, a hot spare disk is generally configured to improve data security. Global hot spare disks and dedicated hot spare disks can be configured as required.

Hot spares are only used for RAID levels where redundancy exists.

The capacity of the hot spare disk is larger than the capacity of a single RAID member disk to contribute to the RAID.

Only disks whose configuration mode is Unconfigured Good are supported as hot spare disks.

Configuring a global hot spare

As shown in Figure 6-115, select the disk to be configured as a global hot spare on the PD Mgmt interface, and press F2.

Figure 6-115 Selecting the disk to be configured as a global hot spare

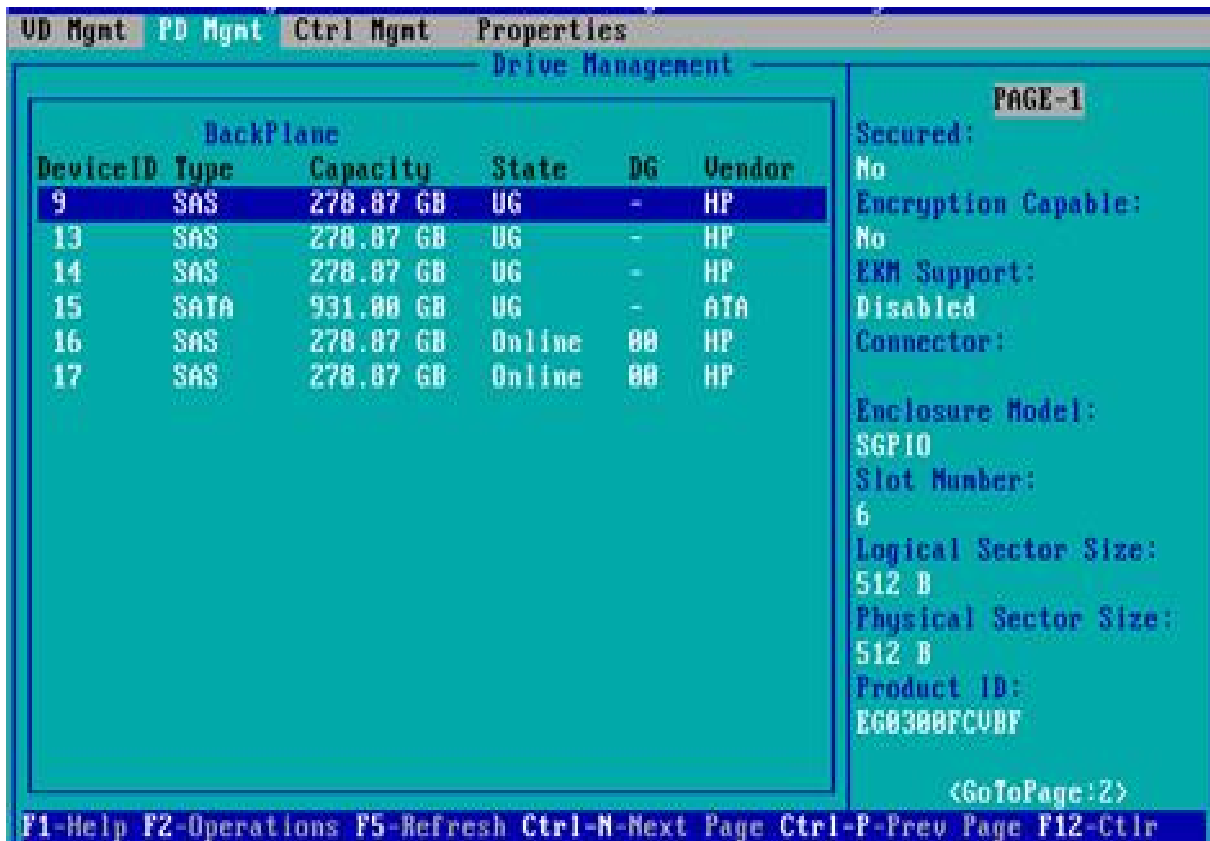

Figure 6- 115

Enter the interface shown in Figure 6-116, select Make Global HS, and press Enter to complete the configuration of the global hot spare disk.

Figure 6-116 Select Make Global HS



Figure 6- 116

Return to the interface shown in Figure 6-117 and select a hot spare to view information about the global hot spare.

Figure 6-117 Viewing global hot spare disk information

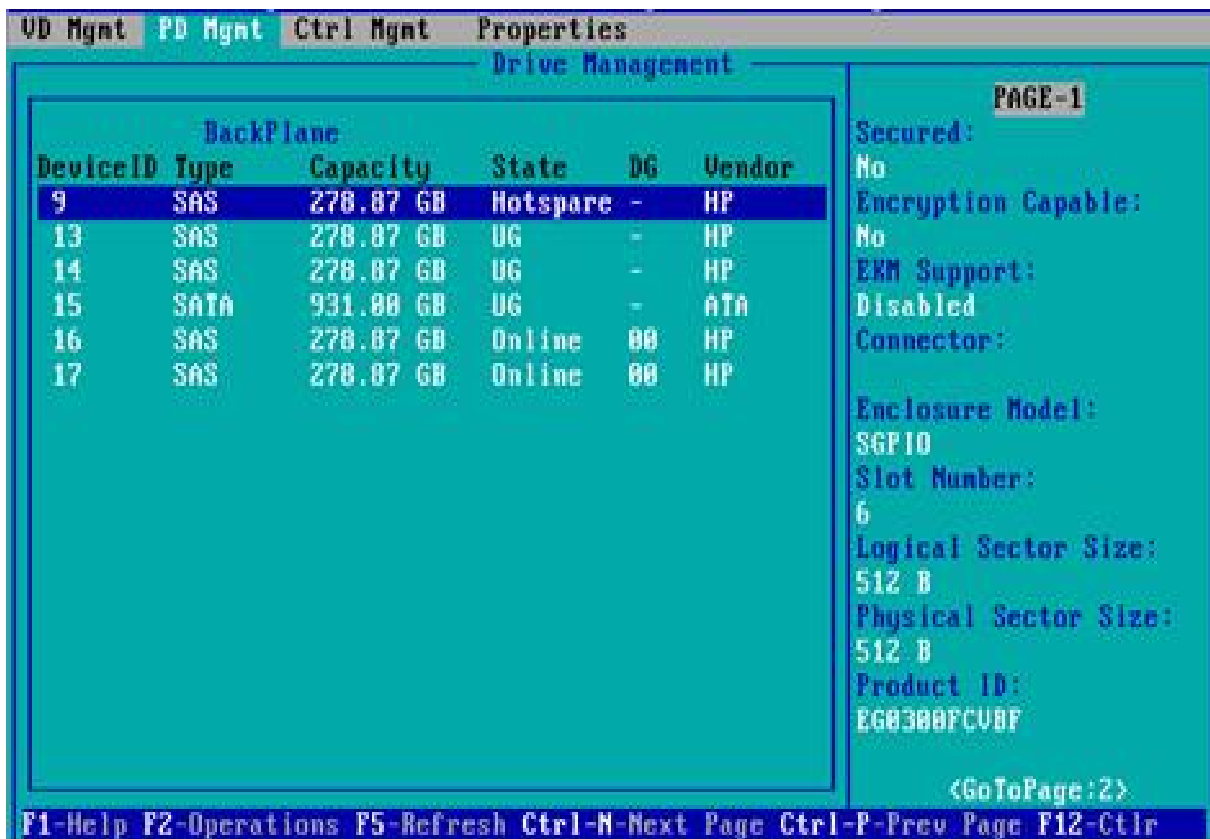

Figure 6- 117

Remove RAID:

This function is used to delete RAID that is damaged or difficult to meet your needs.

As shown in Figure 6-118, select the logical disk to be deleted on the VD Mgmt interface, and press F2.

Figure 6-118 Select the logical disk to be deleted



Figure 6- 118

Enter the interface shown in Figure 6-119, select Delete VD, and press Enter.

Figure 6-119 Select Delete VD

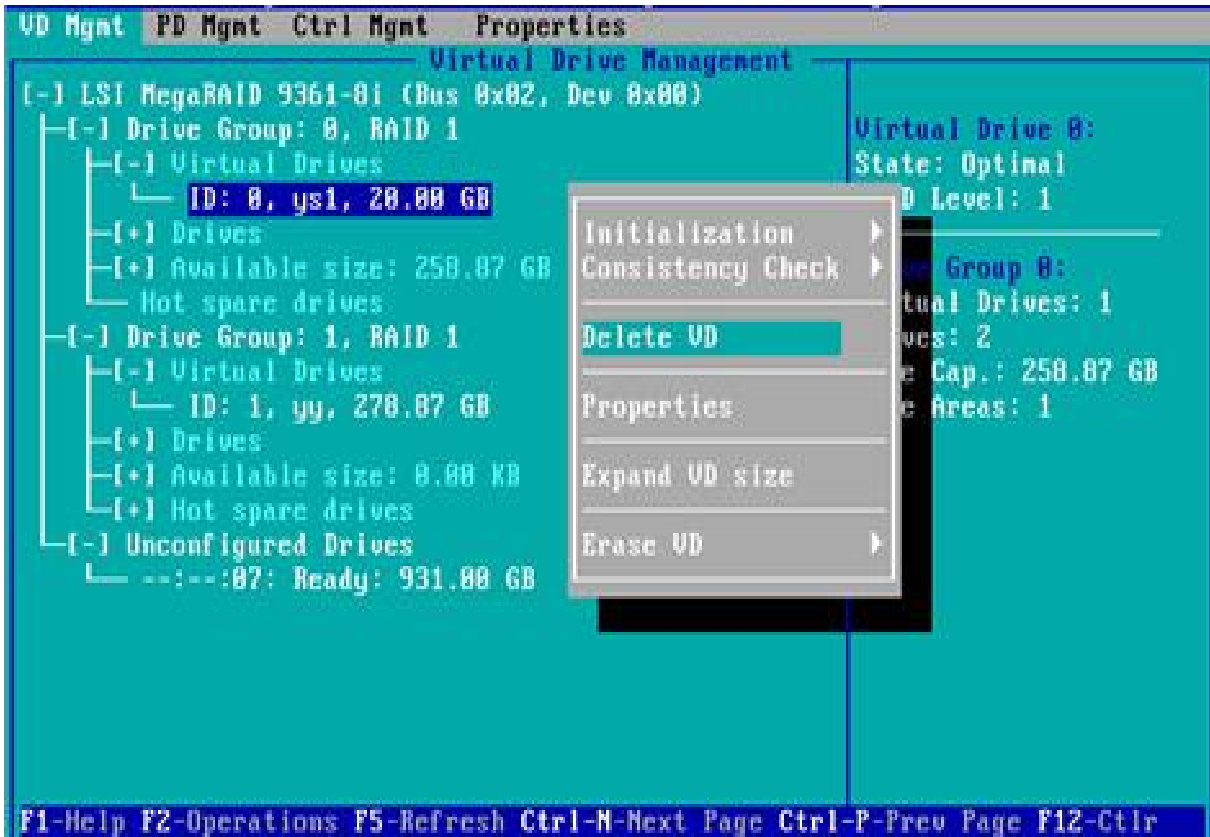

Figure 6- 119

The interface shown in Figure 6-120 is displayed, select YES, and press Enter to complete the RAID deletion operation.

Figure 6-120 Confirm deletion

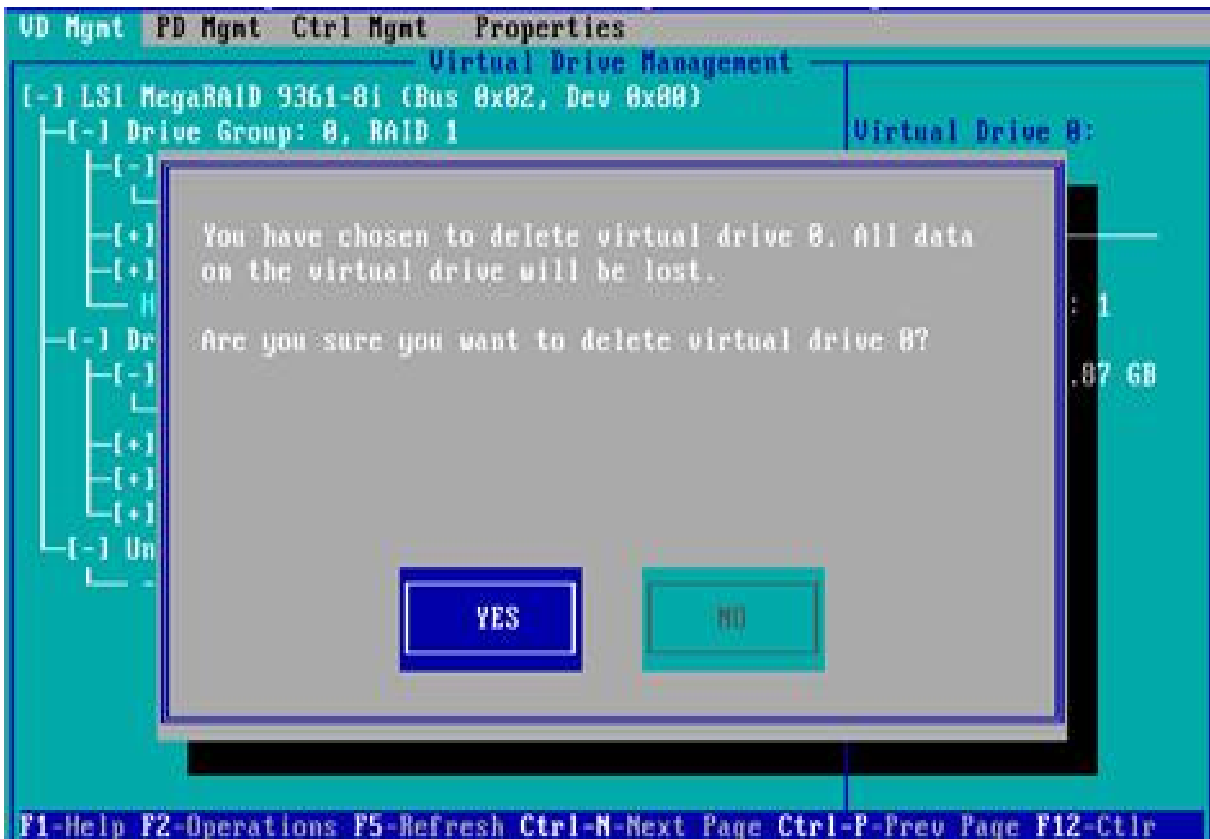

Figure 6- 120

Locate the disk location:

This function makes it easy for you to quickly find the disk by lighting the blue indicator of the corresponding slot of the disk. A single physical disk or all member disks included in a logical disk can be located.

As shown in Figure 6-121, select the disk to be located on the PD Mgmt interface and press F2.
 Figure 6-121 Select the disk to be located

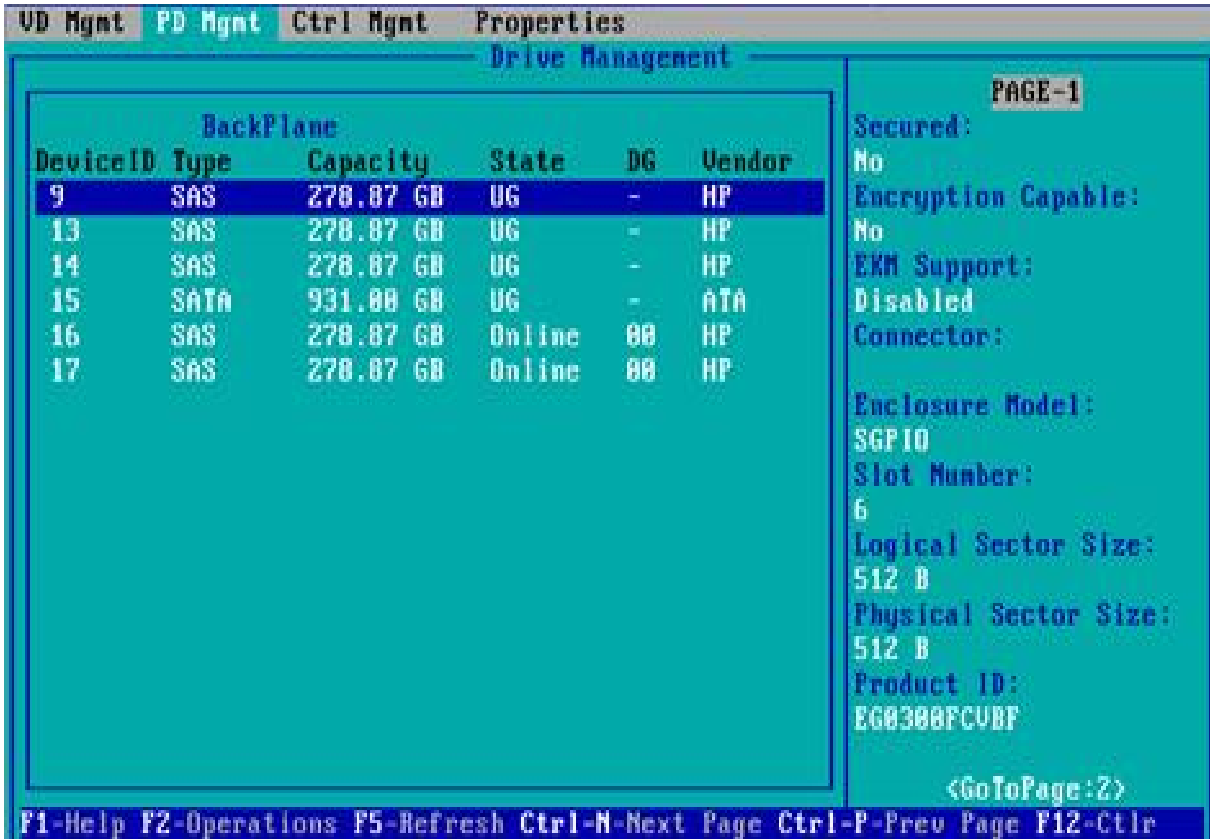

Figure 6- 121

Enter the interface shown in Figure 6-122 and select Locate->Start to complete the disk location operation.

Figure 6-122 Select Locate- >Start



Figure 6- 122

Locate->Start: Start the disk location operation.

Locate->Stop: Stop the locating disk operation.

Initialize the logical disk:

This function is used to initialize the internal data space of the disk so that it can be recognized and used by the operating system.

As shown in Figure 6-123, select the disk to be initialized on the VD Mgmt interface, and press F2.

Figure 6-123 Selecting the disk to be initialized

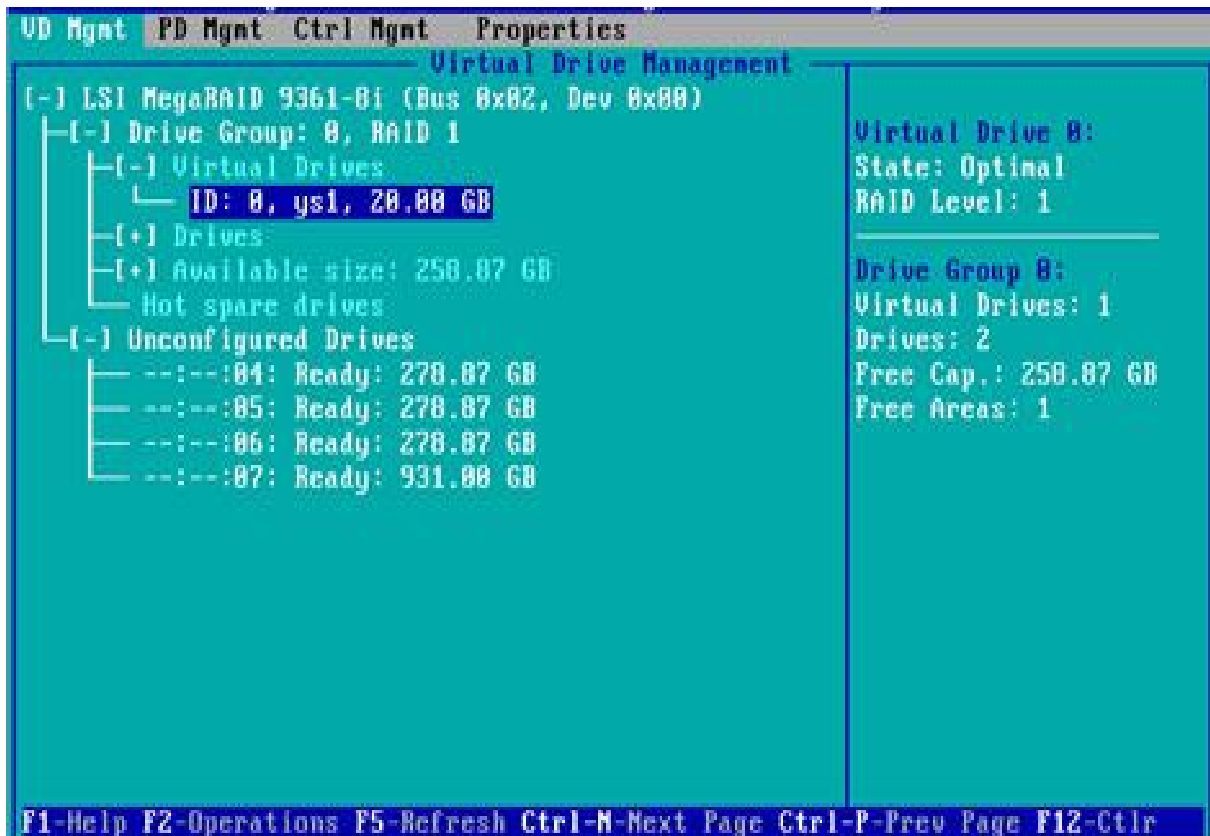

Figure 6- 123

Enter the interface shown in Figure 6-124 and select Initialization->Start FGI.

Figure 6-124 Select Initialization- >Start FGI

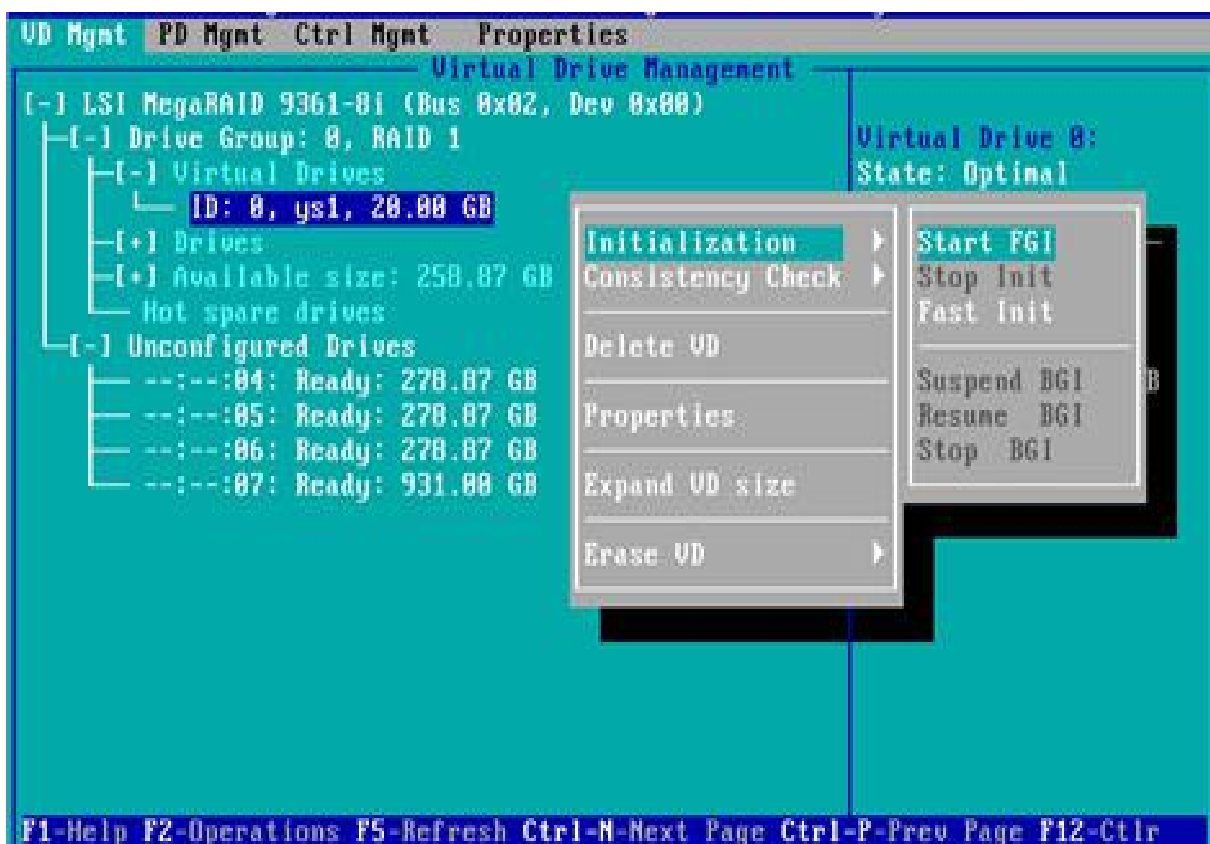

Figure 6- 124

BGI: Background Initialization, background initialization, first initialize part of the RAID space for writing data, and the rest of the space is initialized in the background.

FGI: Full Group Initialization, the whole disk is initialized, all the space of the RAID is initialized, and the

data can be written after the initialization is completed.

Enter the interface shown in Figure 6-125, select YES, and press Enter to complete the disk initialization operation.

Figure 6-125 Confirm initialization

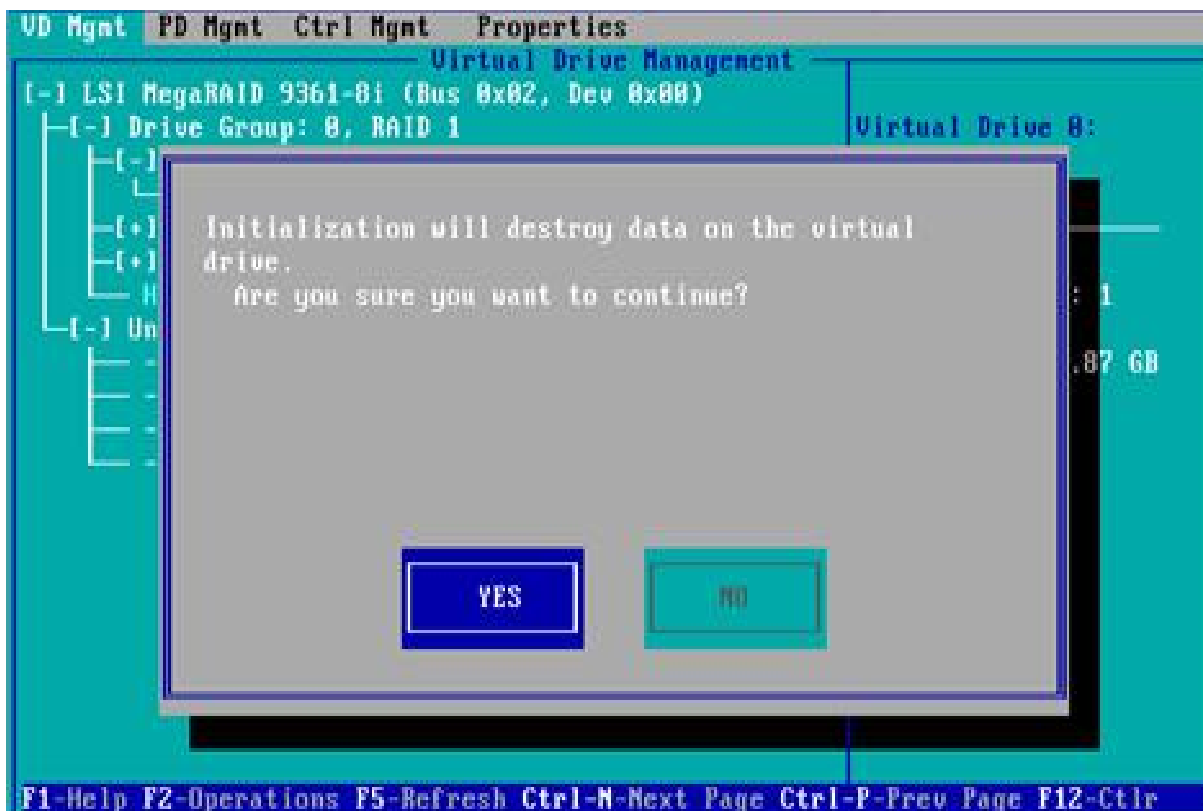

Figure 6- 125

Erase disk data:

This function is used to delete data inside the disk, including erasing physical disk data and logical disk data.

Erase physical disk data

As shown in Figure 6-126, select the physical disk to be erased on the PD Mgmt interface, and press F2.

Figure 6-126 Select the physical disk to be erased

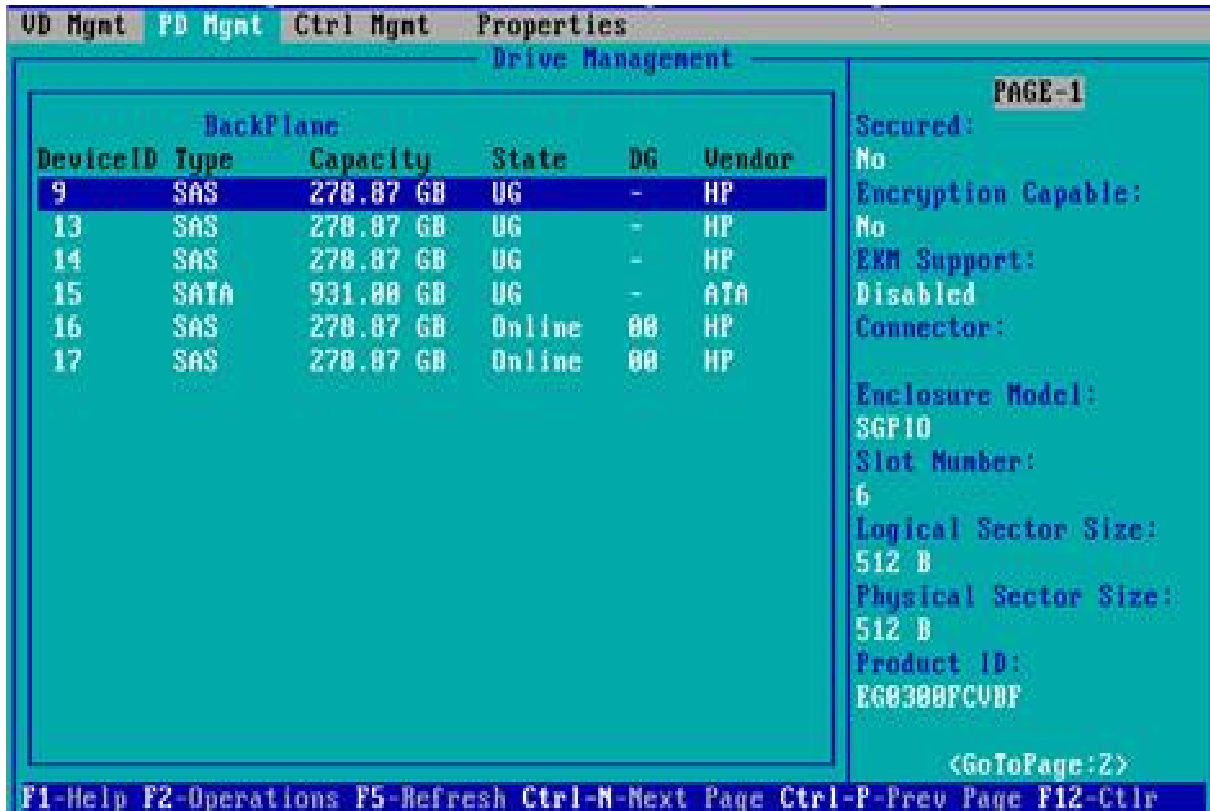

Figure 6- 126

Enter the interface shown in Figure 6-127, select the erase mode (the default mode is recommended: Simple), and press Enter.

Figure 6-127 Select Erase Mode

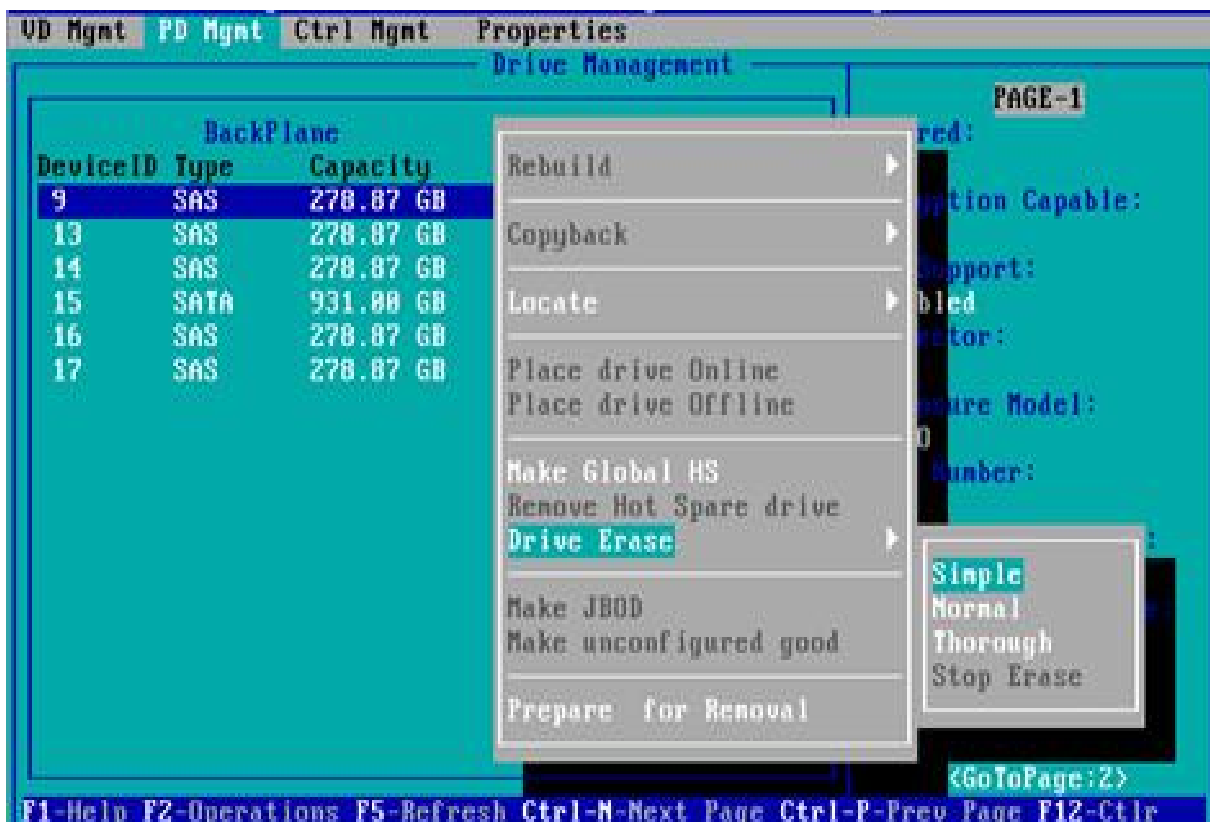

Figure 6- 127

Enter the interface shown in Figure 6-128, select Yes, and press Enter to complete the operation of erasing the physical disk data.

Figure 6-128 Confirm Erase



Figure 6- 128

To avoid disk failure, do not perform other operations while erasing physical disk data.

Erase Logical Disk Data

As shown in Figure 6-129, select the logical disk to be erased on the VD Mgmt interface, and press F2.

Figure 6-129 Select the logical disk to be erased .

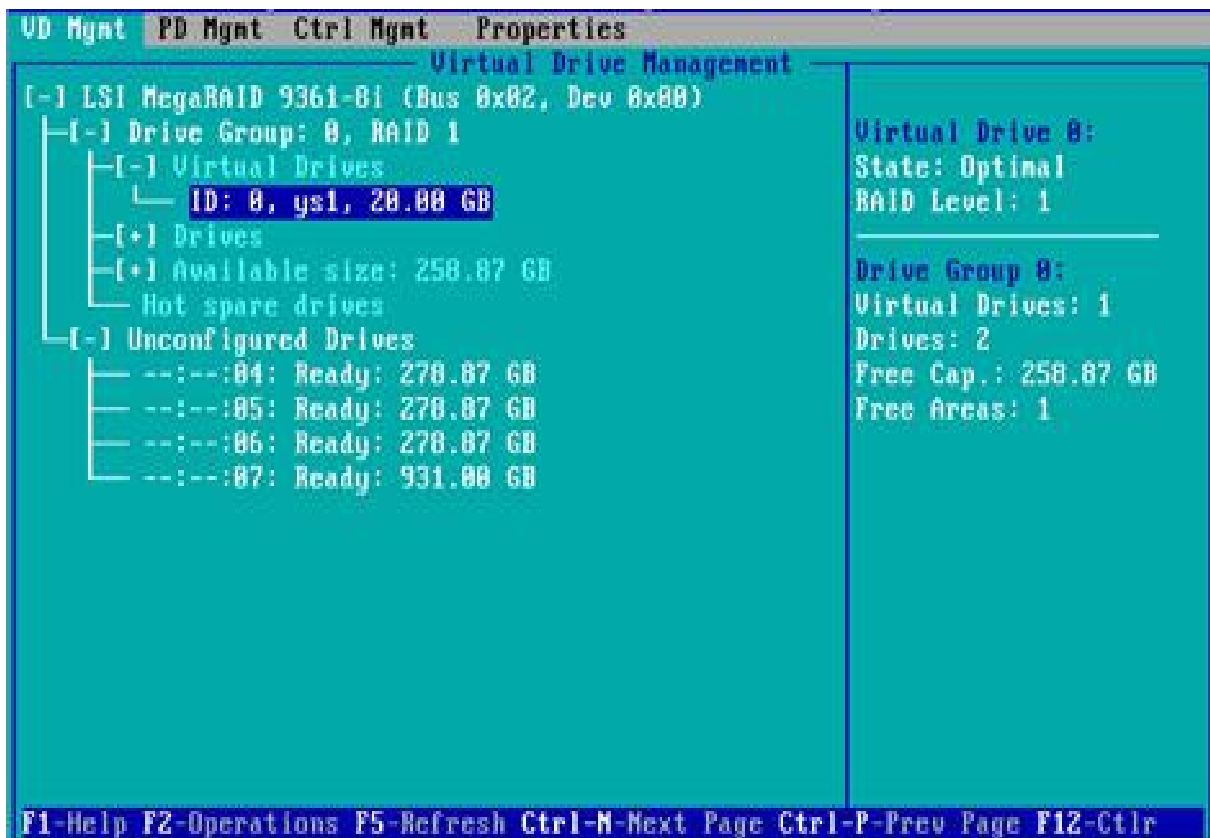

Figure 6- 129

Enter the interface shown in Figure 6-130, select the erase mode (the default mode is recommended: Simple), and press Enter.

Figure 6-130 Select Erase Mode

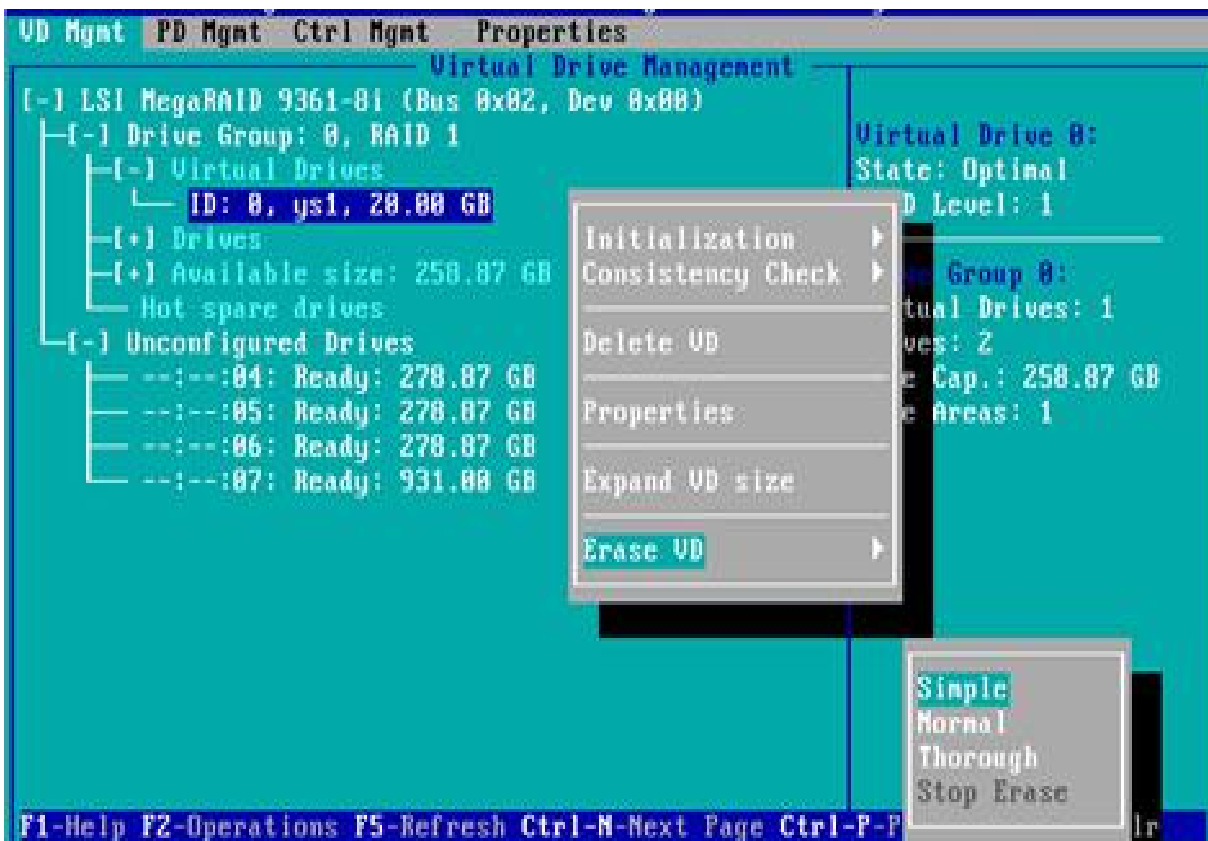

Figure 6- 130

Enter the interface shown in Figure 6-131, select Yes, and press Enter to complete the operation of erasing the logical disk data.

Figure 6-131 Confirm Erase

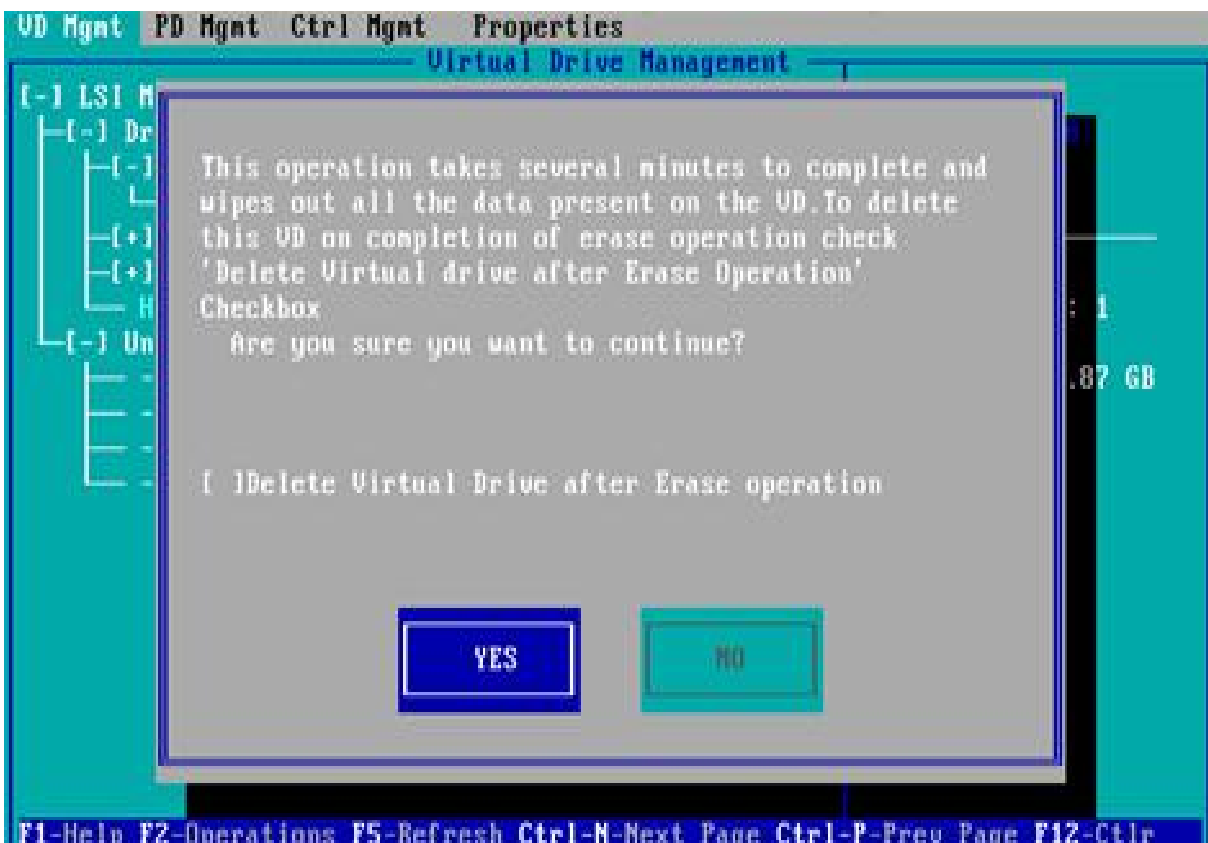

Figure 6- 131

Clear disk RAID information:

This function is used to clear the residual RAID information in the disk, so that the disk can be reused for RAID configuration. This function is often used for disks whose mode is Unconfigured Bad. Switch the disk mode Unconfigured Bad to Unconfigured Good.

As shown in Figure 6-132, on the Foreign View interface, select the RAID controller card, press F2, select Foreign Config->Clear, and press Enter.

Figure 6-132 Select Foreign Config->Clear



Figure 6- 132

In the displayed dialog box shown in Figure 6-133, select OK and press Enter to complete the operation of clearing disk RAID information.

Figure 6-133 Confirm Clear

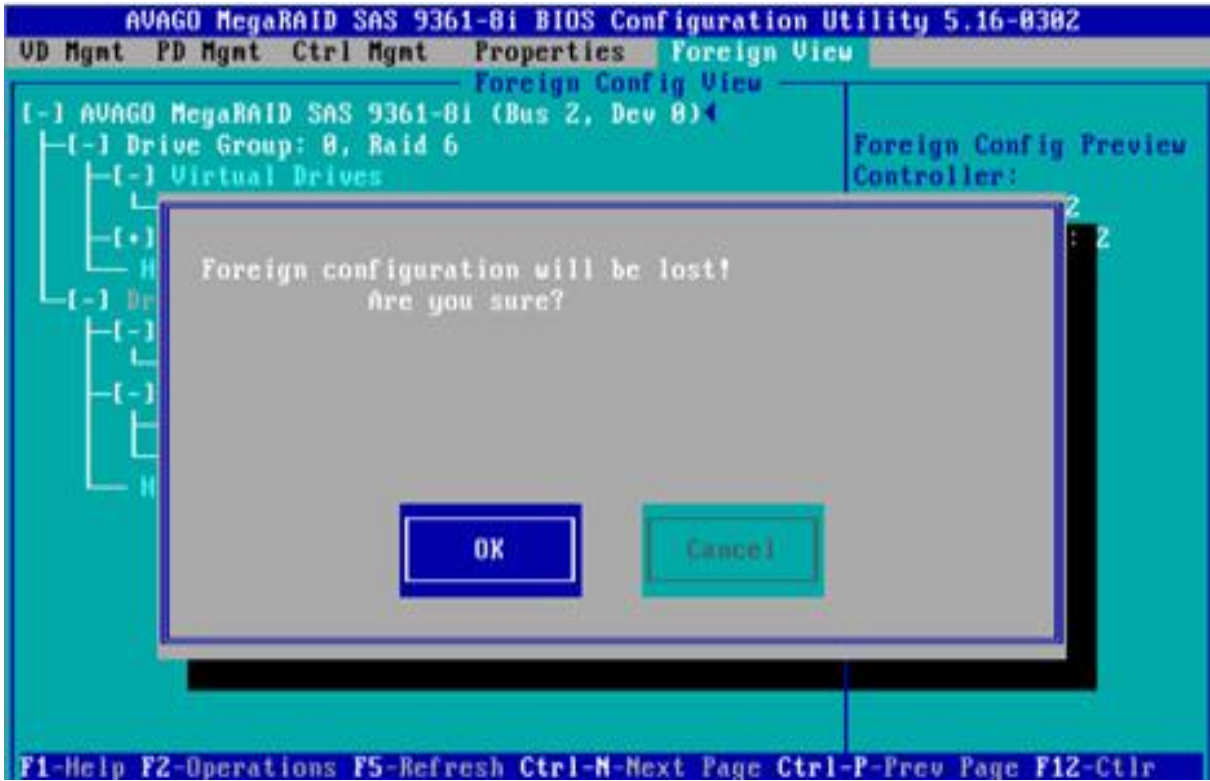

Figure 6- 133

Chapter 7 IPMI Rapid Deployment

7.1 Rapid Deployment of IPMI Process

Figure 7-1 shows the general process of how to quickly deploy the IPMI function of the server.

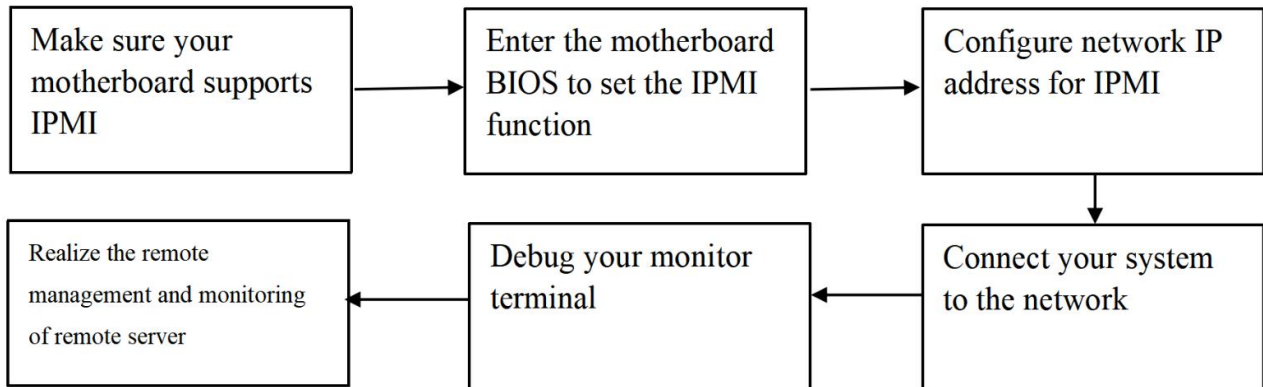

Figure 7-1 IPMI deployment process

7.1.1 Make sure the motherboard supports the IPMI function

Check your motherboard manual and confirm that your motherboard supports IPMI, and then find the dedicated IPMI network port for the motherboard, or you can choose a shared network port, as shown in Figure 7-2.

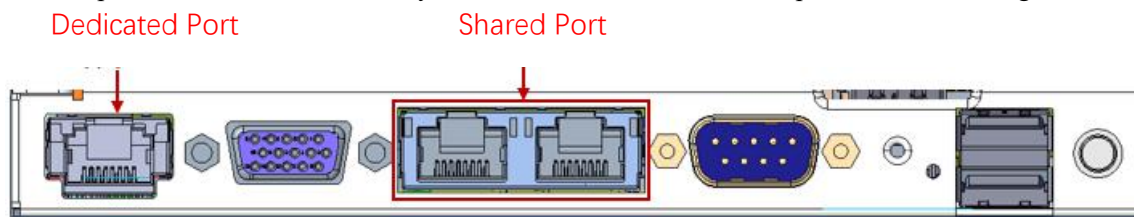

Figure 7-2 Motherboard dedicated network port

7.1.2 Enter BIOS to set IPMI function

Reboot your system and press ESC or DEL key while the device is booting to enter the motherboard BIOS system. The BIOS setting interface is shown in Figure 7-3 below.

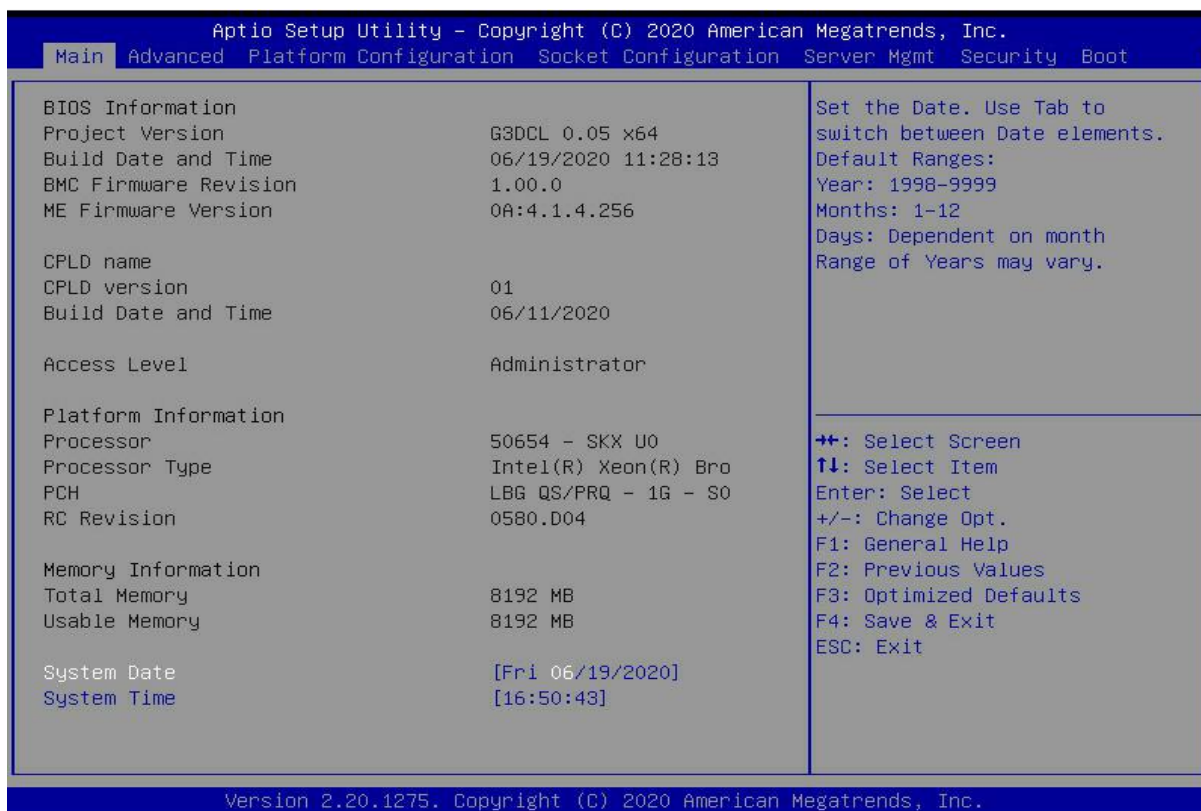

Figure 7-3 Motherboard BIOS setting interface

After entering this interface, use the left and right keys on the keyboard to switch the menu item to the Server Mgmt option, and you will see the page shown in Figure 7-4.

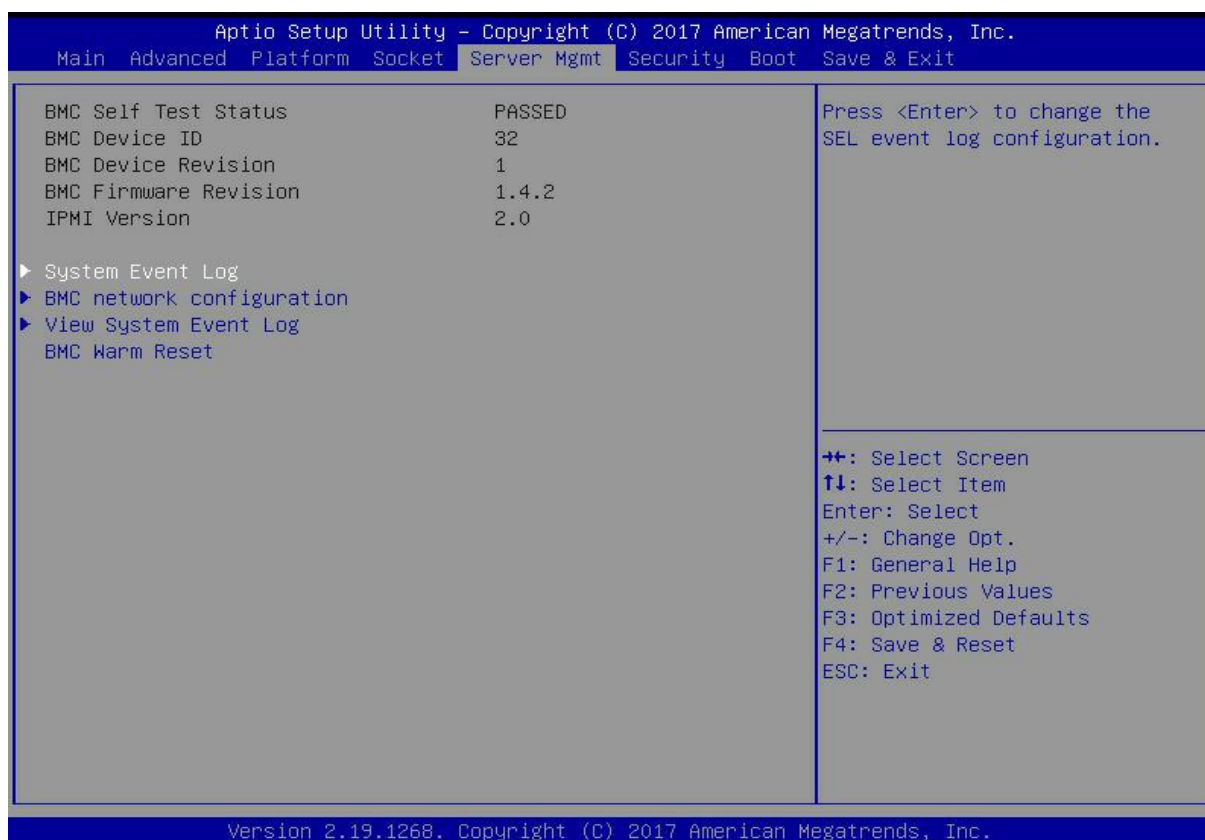

Figure 7-4 Server Mgmt interface

After entering this interface, enter the BMC network configuration option through the keyboard, and you will enter the following interface, as shown in Figure 7-5.

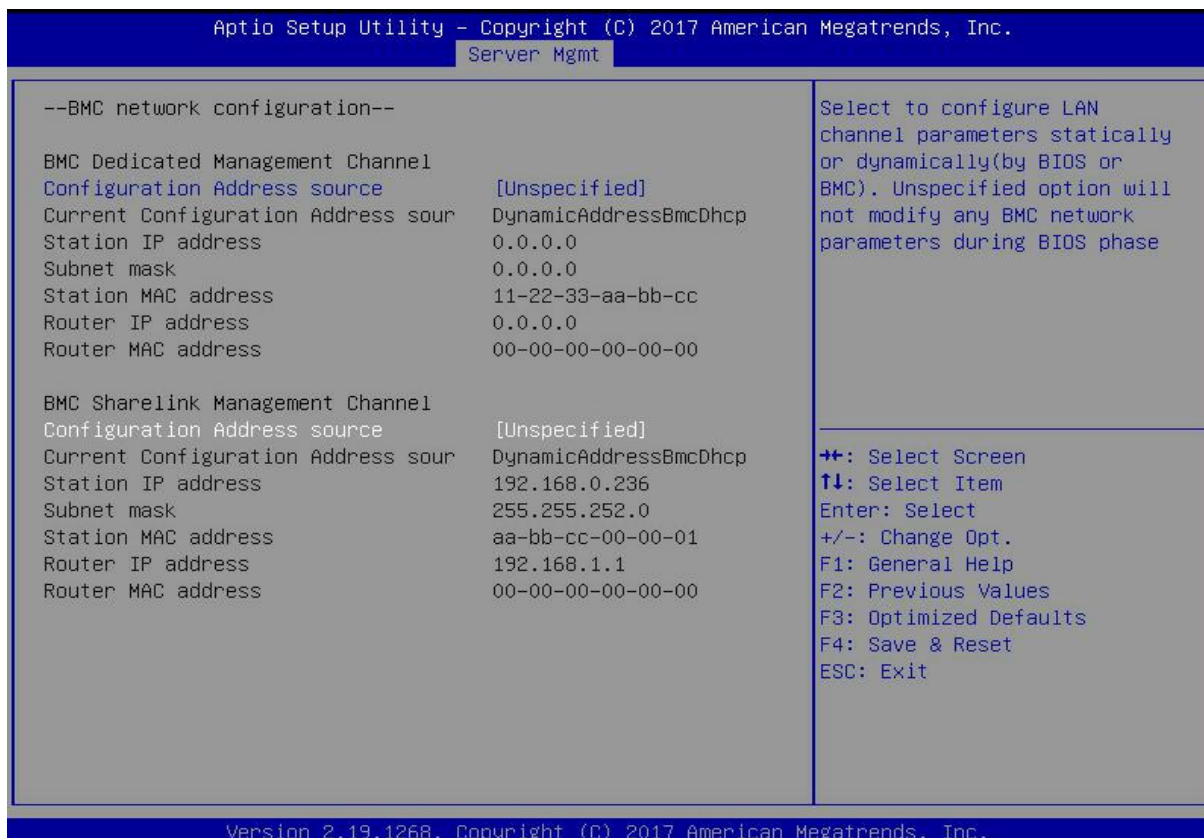

Figure 7-5 BMC network configuration option interface

On this page, you can see two configurable network ports, one is the dedicated network port for Dedicated, and the other is the shared network port for Sharelink. Take the shared network port as an example here. If you connect a dedicated network port, the setting method is the same as the shared network port. Switch to the Configuration Address Source option and press Enter to set the network mode of the network port, as shown in Figure 7-6.

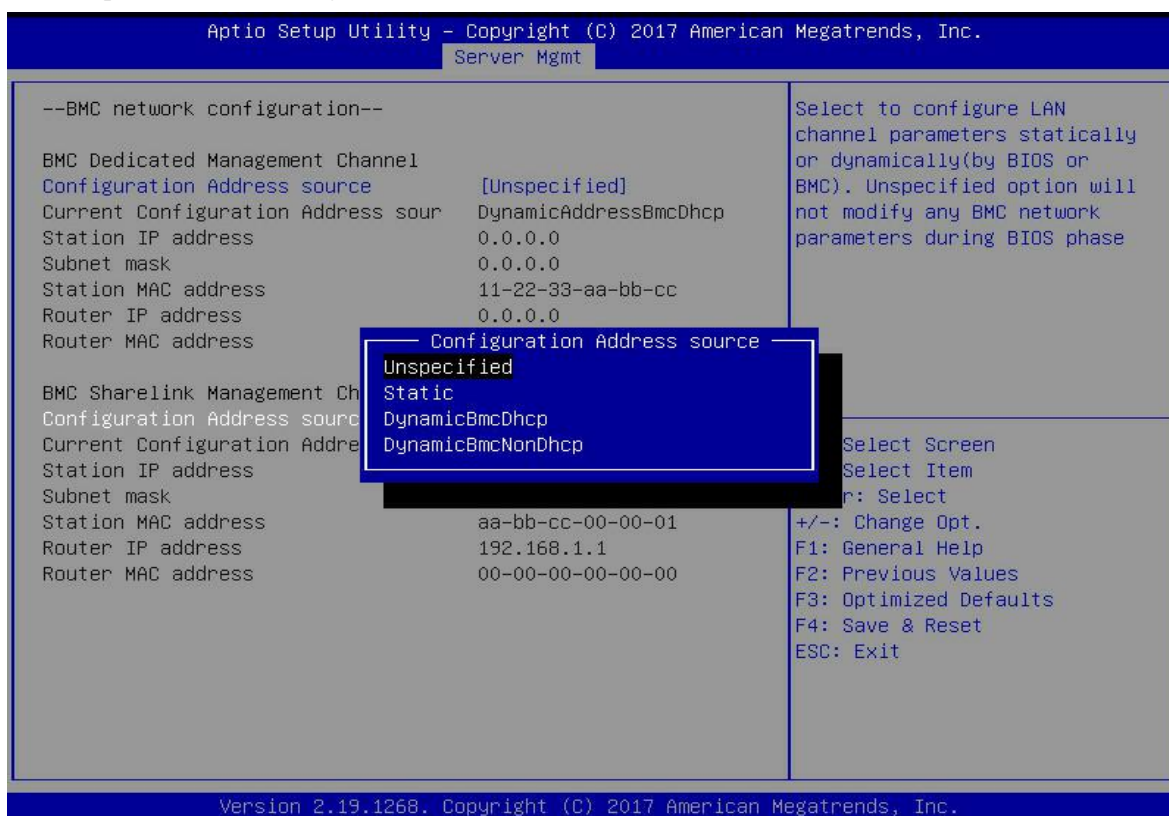

Figure 7-6 Configuring the network port network mode

There are four network modes that can be configured on this interface, namely Unspecified, Static, DynamicBMCDHCP, and DynamicBMCNonDHCP. Static is the static mode, you can manually set the IP address, and DHCP is the dynamic mode. Setting this item allows the BMC to automatically obtain the IP address from the DHCP server.

7.1.3 IPMI port configuration Static mode

If you choose to configure Static mode for an IPMI port, pay attention to the following issues:

(1) If there are multiple IPMI devices in your local area network, it should be noted that the IP addresses between the devices cannot be repeated, otherwise communication cannot be established.

(2) If the IP of your IPMI device is an intranet address, the terminal device that communicates with it must be in the same network segment as the address of the IPMI device.

(3) The IP address of the IPMI device can be mapped to the WAN through the routing device to achieve long-distance management.

(4) The IPMI port has the function of obtaining an IP address through DHCP.

(5) IPMI supports both TCP/IP v4 and TCP/IP v6 protocols.

Configure the IP address and subnet mask according to your actual situation. For example, here we set the IP address to 192.168.0.236 and the subnet mask to 255.255.252.0, as shown in Figure 7-7 below. After setting, press F4 to save and exit the BIOS port.

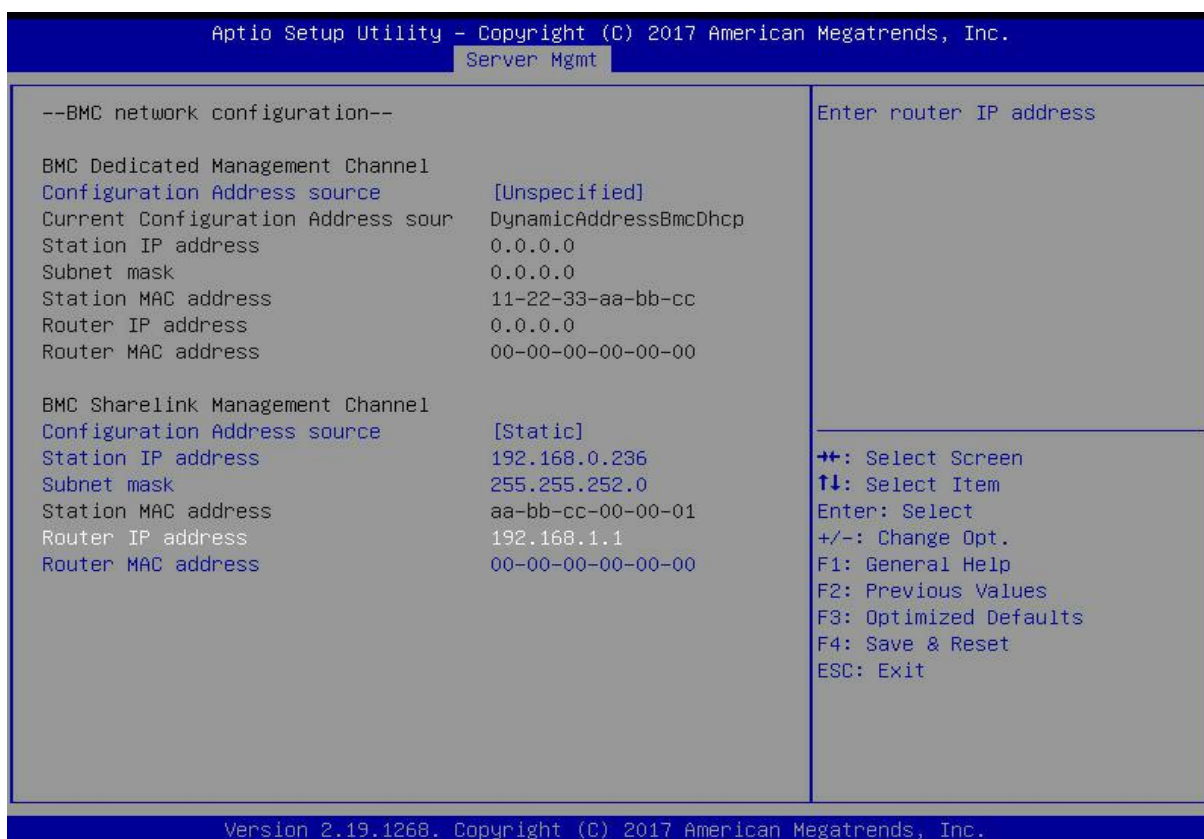

Figure 7-7 Static Mode Settings

We have completed the operation of configuring the IPMI function.

7.1.4 IPMI configuration Java SOL

1. Press the key when the system starts to enter the BIOS setup interface.
2. Switch to the Advanced menu, select Serial Port Console Redirection, and press <Enter>.
3. Make sure that the Console Redirection of COM0 is in the [Enabled] state, if not, select Console Redirection, and then press the <Enter> key to set the state to [Enabled]. To ensure the normal operation

of iBMC, this option is set to [Enabled] by default.

7.2 Quick Start Instructions for IPMI Functions

After completing the previous configuration steps, we can start to log in to the management interface of IPMI. The management interface of IPMI can be accessed using standard web browsers. Here we recommend using Google Chrome browser, Firefox Firefox browser and IE browser. browser (IE 11 and above) for the best browsing experience. Since the new version of the operation interface is based on HTML5, the overhead of computer resources is relatively large. We recommend that users configure more than 8G memory on the client side when using KVM.

7.2.1 Enter the operation interface

Taking the Google Chrome browser as an example, enter the access address of IPMI in the address bar of the browser and press Enter to access the management interface of IPMI. Since all HTTP links have been converted to HTTPS encrypted links, you will enter Figure 7-8. Privacy settings error page shown, other browsers may vary.

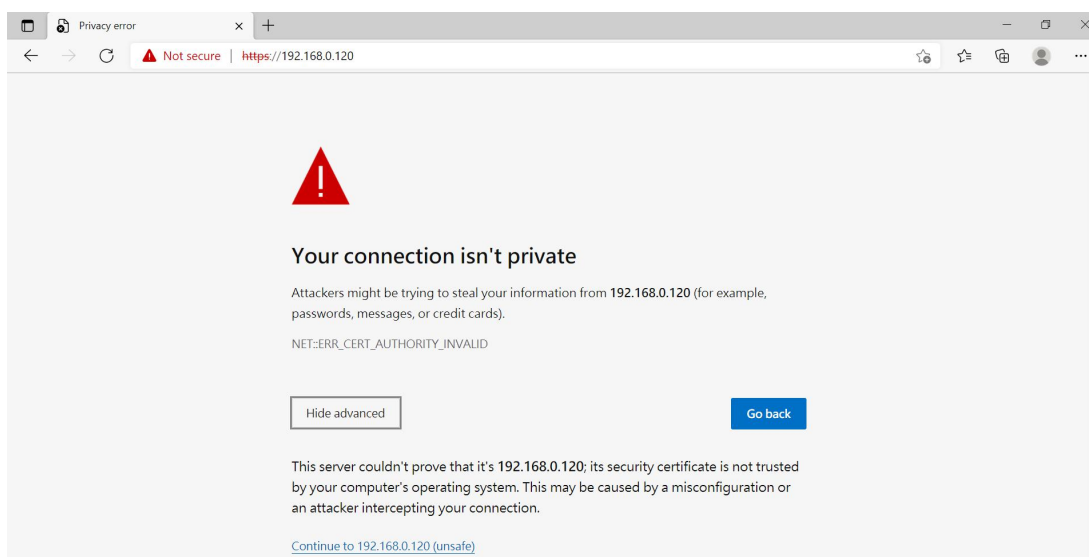

Figure 7-8 Google Chrome Privacy Settings Error Page

On this page, click "Advanced" >> "Continue" in turn, you can access the IPMI management page normally, and enter the login page, as shown in Figure 7-9.

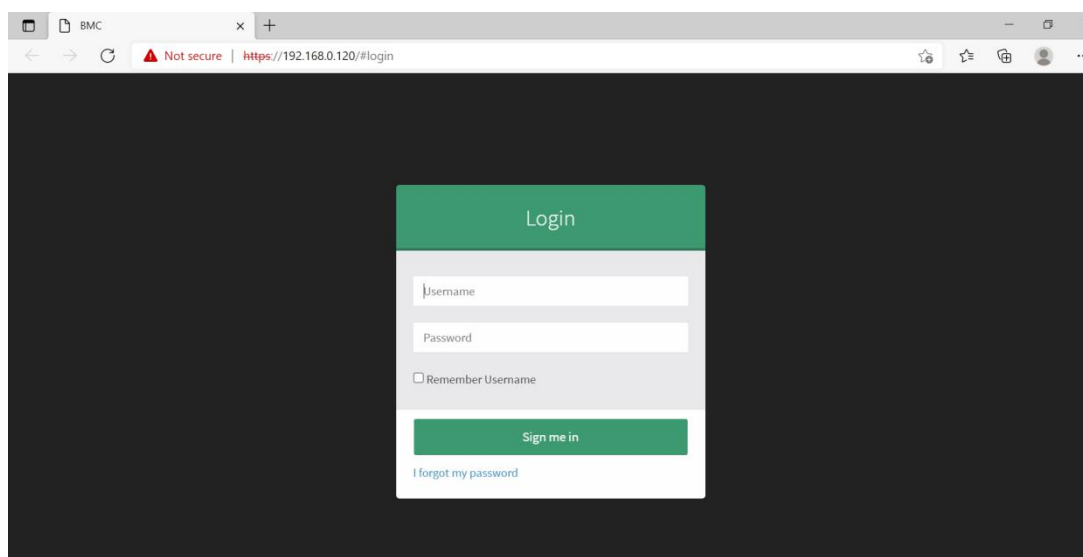

Figure 7-9 IPMI management login interface

7.2.2 Default Username and Password

Factory default username: admin

Factory default password: admin

When you log in with this username, you will have full administrator rights. It is recommended that you change the password after logging in.

7.2.3 Contents of IPMI Management System

After you log in to the IPMI management system correctly, you can see the page shown in Figure 7-10.

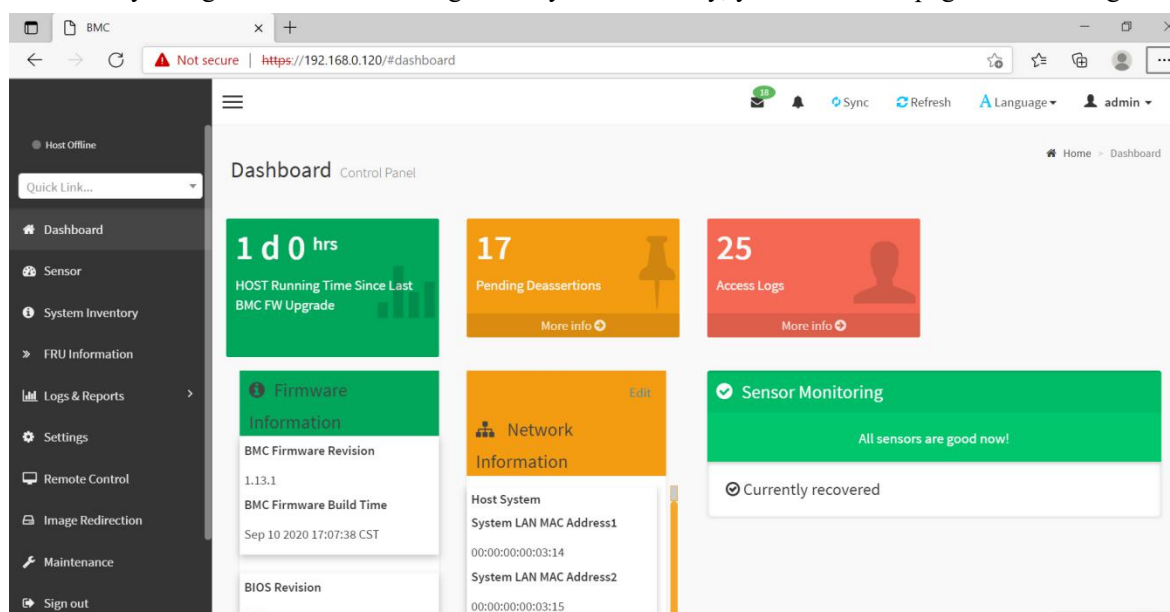

IPMI management interface menu description

- Dashboard

On this page, users can view the basic information of the IPMI management system. Includes firmware information, network information, and sensor monitoring information.

The firmware information includes BMC firmware version information, BIOS version information, mainboard CPLD version information, backplane CPLD version information, and BMC firmware compilation time information.

The network information includes the MAC address of the system network and BMC network information. You can choose to view the shared network port or dedicated network port of the BMC. The BMC network information includes BMC network MAC address information, IPV4 network mode information, IPV4 address information, IPV6 network mode information, and IPV6 address information.

Sensor monitoring information will display the current alarm sensor information in real time, including sensor name, sensor reading, real-time curve change of sensor reading, and alarm status.

- Sensor

This page displays the status of all sensors. When there is a sensor alarm, the sensor will be displayed in the key sensor column, and when the alarm is removed, the sensor will be automatically removed from the key sensor column.

- System inventory

This page can view server CPU and memory information. In the block diagram, click on the CPU block to view the CPU information. The memory block is displayed in green to indicate that the memory exists. Click the memory block with the mouse to view the memory information.

- Hard disk information

For the backplane with Expander, a green square indicates that the hard disk is in place, otherwise it indicates that it is not in place. The status of the hard disk can be viewed on the right or below the hard disk block. Left-click the green square to view the detailed information of the hard

disk, and right-click to locate the hard disk.

- Power consumption

In this menu, the power consumption can be capped, and the recent power consumption can also be viewed.

- FRU information

Select this menu to view basic FRU information.

- Logs & Reports

In this menu, you can view the IPMI time log, audit log and video log.

- Settings

BMC can be configured in this menu. Including BSOD, date & time, network, etc...

- Remote control

On this page, KVM, SOL can be started, and power control and UID (server logo light) control can also be performed.

- Image redirection

On this page, you can get the latest image file on the remote storage device.

- Maintenance

You can perform basic maintenance operations on the server, such as BMC firmware update, BIOS firmware update.

- Cancellation

Click to log out the current user's login.

7.2.4 Introduction to KVM Remote Management

Start KVM remote management

As shown in Figure 7-11, in Remote Control > KVM & Java SOL Remote Control menu, KVM can be started.

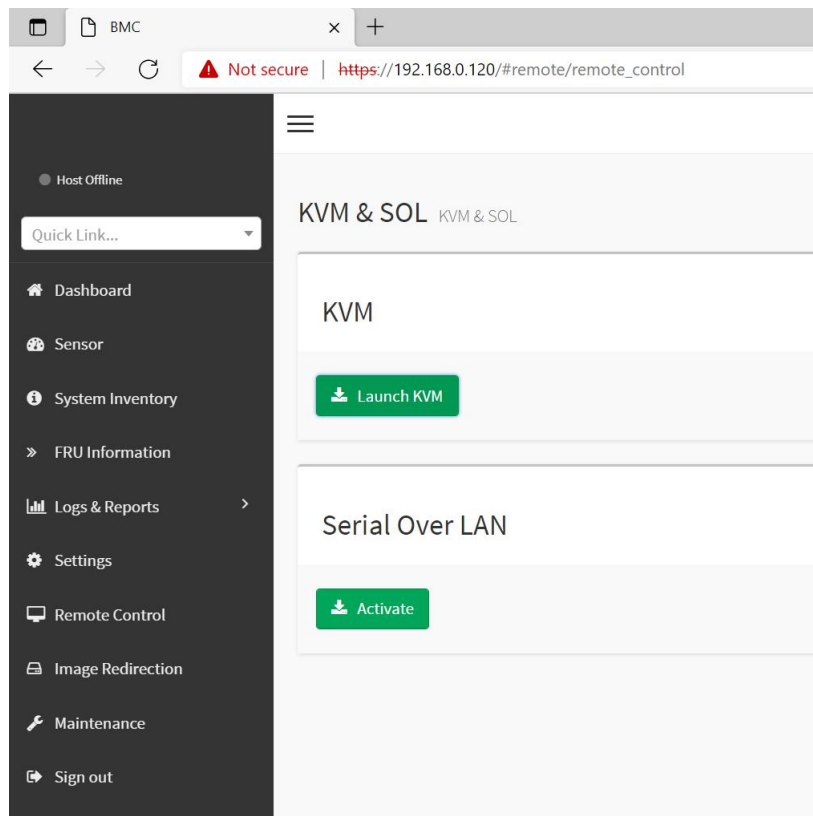

Figure 7-11 Start KVM



Figure 7-13 Composition of KVM interface

7.2.6 Remote control shortcut operation



	<p>Stop KVM</p>
	<p>Hanging on the CD image, generally used to remotely install the operating system</p>
	<p>The host display is unlocked, the server is turned on/off</p>

Table 1- 41

7.2.7 Introduction to SOL

Click Activate Java SOL on the page shown in Figure 7-14 to open the interface shown below.

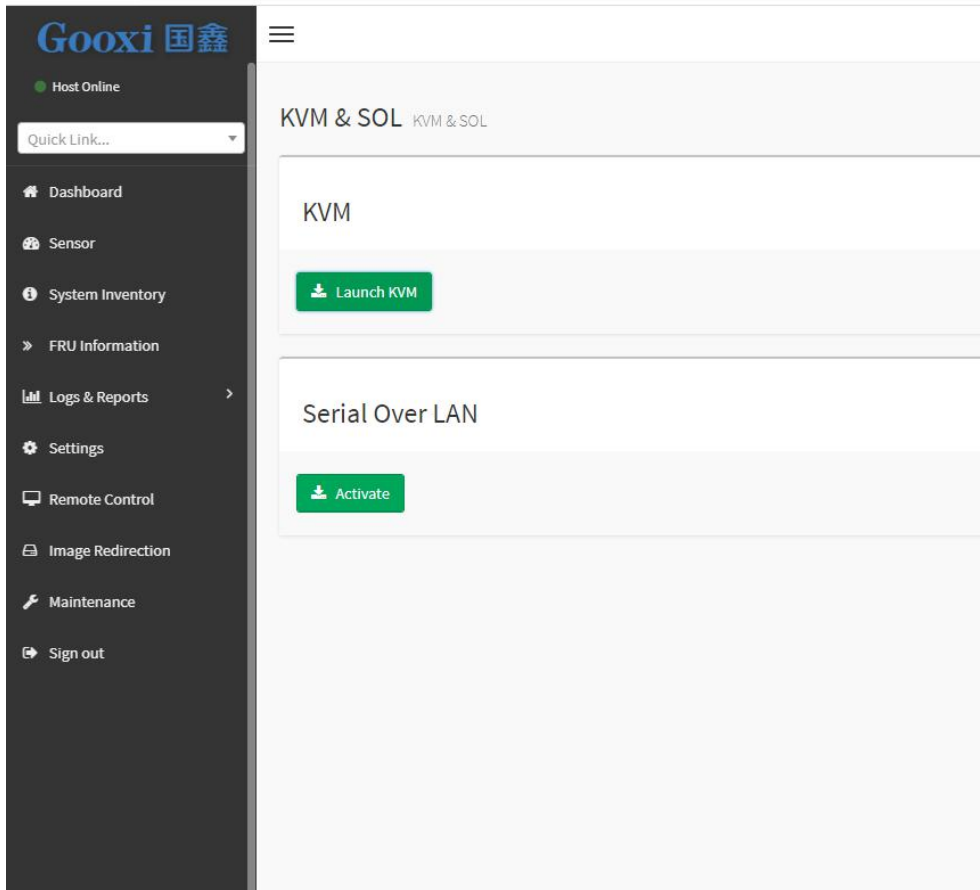

Figure 7-14 Enabling Java SOL

1. After clicking to activate, the SOL interface shown in Figure 7-15 will appear.
2. Press Enter to activate the screen.

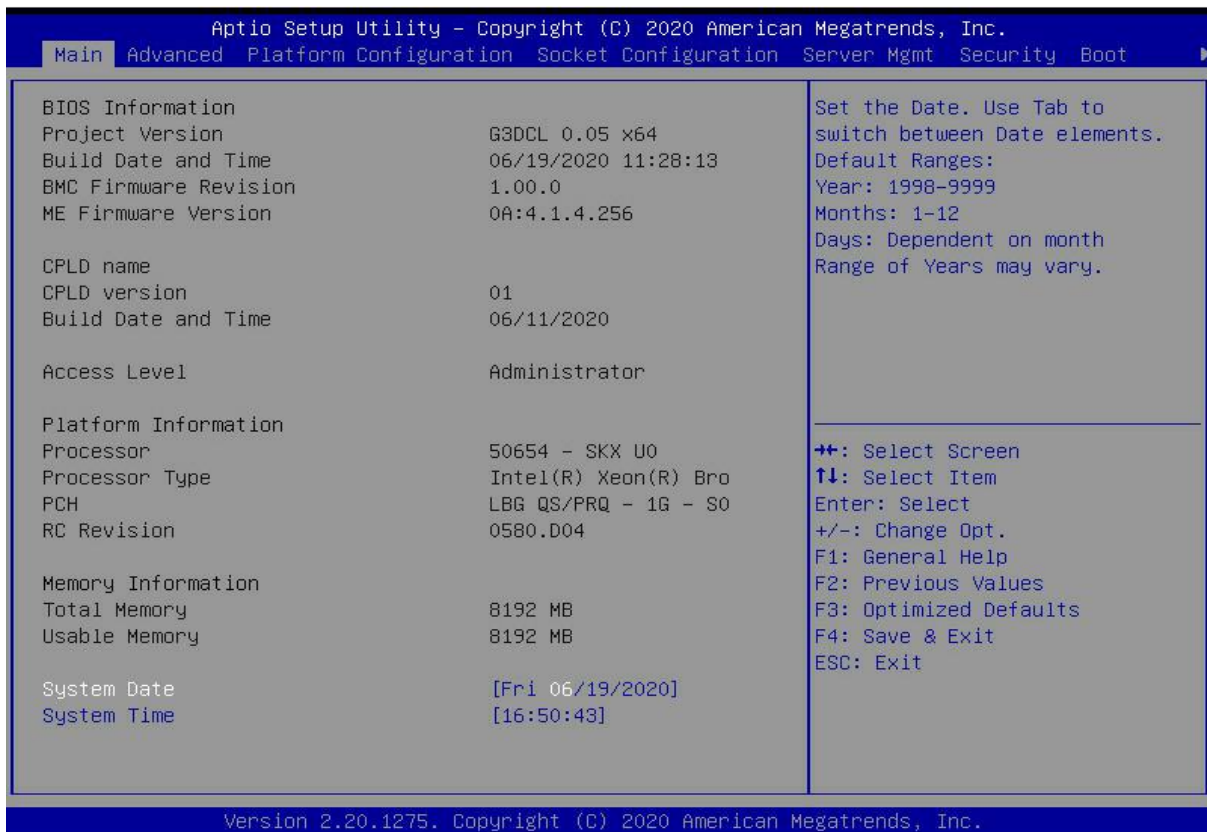

Figure 7-15 SOL operation interface

Note: The SOL interface operation function has only been tested for BIOS screen synchronization, and

other interfaces have not been tested. This time is an operation demonstration and will not be described in detail.

7.3 Other ways to connect to IPMI

The AST2500 firmware complies with the IPMI 2.0 specification, so users can use the standard IPMI driver assigned by the operating system.

7.3.1 IPMI driver

The AST2500 supports Intel-referenced drivers, available from: <https://www.intel.com/content/www/us/en/servers/ipmi/ipmi-technical-resources.html> via Windows Server 2003 R2, Microsoft also An IPMI driver package is provided, you can also use the Open IPMI driver in the system.

AST2500 supports Open IPMI driver for Linux kernel. Use the following command to load the IPMI driver: "modprobe ipmi_devintf" "modprobe ipmi_si" If you are using an older version of the Linux kernel, you need to replace the "ipmi_si" component with "ipmi_kcs".

7.3.2 IPMI tools and other open source software

AST2500 supports open source IPMI tools, you can also use other software, such as: Open IPMI, IPMI Utility, etc.

The above files are designed to help you quickly understand and deploy the IPMI function of the system. We will provide other help files for the detailed IPMI function operation manual.